

Thermally-Enhanced High Power RF LDMOS FETs 200 W, 2110 – 2170 MHz

Description

The PTFA212001E and PTFA212001F are 200-watt LDMOS FETs designed for single- and two-carrier WCDMA power amplifier applications in the 2110 to 2170 MHz band. Features include input and output matching, and thermally-enhanced packages with slotted or earless flanges. Manufactured with Infineon's advanced LDMOS process, these devices provide excellent thermal performance and superior reliability.

PTFA212001E
Package H-36260-2

PTFA212001F
Package H-37260-2

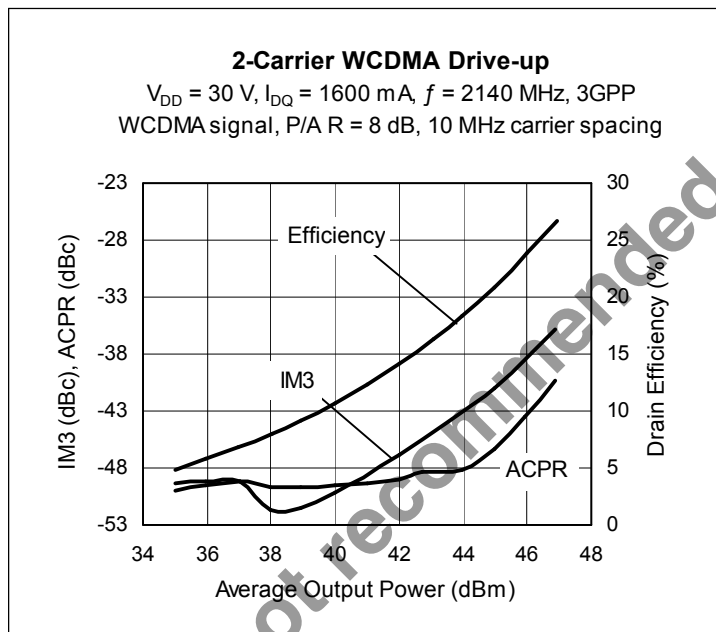

Features

- Thermally-enhanced packages, Pb-free and RoHS compliant
- Broadband internal matching
- Typical two-carrier WCDMA performance at 2140 MHz, 30 V
 - Average output power = 50 W
 - Linear Gain = 15.8 dB
 - Efficiency = 28%
 - Intermodulation distortion = -35.5 dBc
 - Adjacent channel power = -40 dBc
- Typical single-carrier WCDMA performance at 2140 MHz, 30 V, 3GPP signal, P/AR = 7.5 dB
 - Average output power = 70 W
 - Linear Gain = 15.5 dB
 - Efficiency = 34%
 - Adjacent channel power = -37 dBc
- Typical CW performance, 2170 MHz, 30 V
 - Output power at P-1dB = 220 W
 - Efficiency = 54%
- Integrated ESD protection: Human Body Model, Class 2 (minimum)
- Excellent thermal stability, low HCI drift
- Capable of handling 5:1 VSWR @ 30 V, 200 W (CW) output power

All published data at $T_{CASE} = 25^{\circ}\text{C}$ unless otherwise indicated

ESD: Electrostatic discharge sensitive device—observe handling precautions!

RF Characteristics

WCDMA Measurements (tested in Infineon test fixture)

$V_{DD} = 30\text{ V}$, $I_{DQ} = 1.6\text{ A}$, $P_{OUT} = 50\text{ W}$ average

$f_1 = 2135\text{ MHz}$, $f_2 = 2145\text{ MHz}$, 3GPP signal, channel bandwidth = 3.84 MHz, peak/average = 8 dB @ 0.01% CCDF

Characteristic	Symbol	Min	Typ	Max	Unit
Gain	G_{ps}	15.3	15.8	—	dB
Drain Efficiency	η_D	26.5	28	—	%
Intermodulation Distortion	IMD	—	-35.5	-34	dBc

Two-tone Measurements (not subject to production test—verified by design/characterization in Infineon test fixture)

$V_{DD} = 30\text{ V}$, $I_{DQ} = 1.6\text{ A}$, $P_{OUT} = 200\text{ W PEP}$, $f = 2140\text{ MHz}$, tone spacing = 1 MHz

Characteristic	Symbol	Min	Typ	Max	Unit
Gain	G_{ps}	—	15.8	—	dB
Drain Efficiency	η_D	—	38.5	—	%
Intermodulation Distortion	IMD	—	-28	—	dBc

DC Characteristics

Characteristic	Conditions	Symbol	Min	Typ	Max	Unit
Drain-Source Breakdown Voltage	$V_{GS} = 0\text{ V}$, $I_{DS} = 10\text{ mA}$	$V_{(BR)DSS}$	65	—	—	V
Drain Leakage Current	$V_{DS} = 30\text{ V}$, $V_{GS} = 0\text{ V}$	I_{DSS}	—	—	1.0	μA
	$V_{DS} = 63\text{ V}$, $V_{GS} = 0\text{ V}$	I_{DSS}	—	—	10.0	μA
On-State Resistance	$V_{GS} = 10\text{ V}$, $V_{DS} = 0.1\text{ V}$	$R_{DS(on)}$	—	0.05	—	Ω
Operating Gate Voltage	$V_{DS} = 30\text{ V}$, $I_{DQ} = 1.6\text{ A}$	V_{GS}	2.0	2.5	3.0	V
Gate Leakage Current	$V_{GS} = 10\text{ V}$, $V_{DS} = 0\text{ V}$	I_{GSS}	—	—	1.0	μA

Maximum Ratings

Parameter	Symbol	Value	Unit
Drain-Source Voltage	V_{DSS}	65	V
Gate-Source Voltage	V_{GS}	-0.5 to +12	V
Junction Temperature	T_J	200	°C
Total Device Dissipation	P_D	625	W
Above 25°C derate by		3.57	W/°C
Storage Temperature Range	T_{STG}	-40 to +150	°C
Thermal Resistance ($T_{CASE} = 70^\circ\text{C}$, 200 W CW)	$R_{\theta JC}$	0.28	°C/W

Ordering Information

Type and Version	Package Type	Package Description	Marking
PTFA212001E V4	H-36260-2	Thermally-enhanced slotted flange, single-ended	PTFA212001E
PTFA212001F V4	H-37260-2	Thermally-enhanced earless flange, single-ended	PTFA212001F

Typical Performance (data taken in a production test fixture)

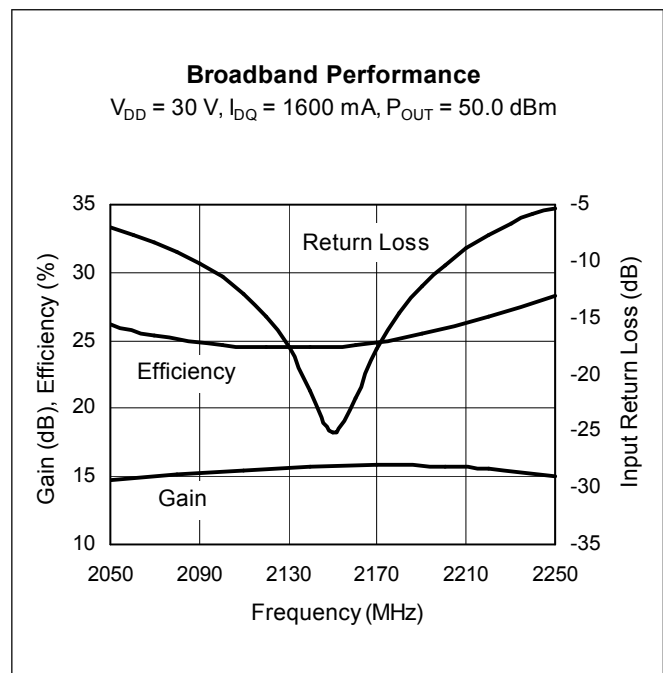
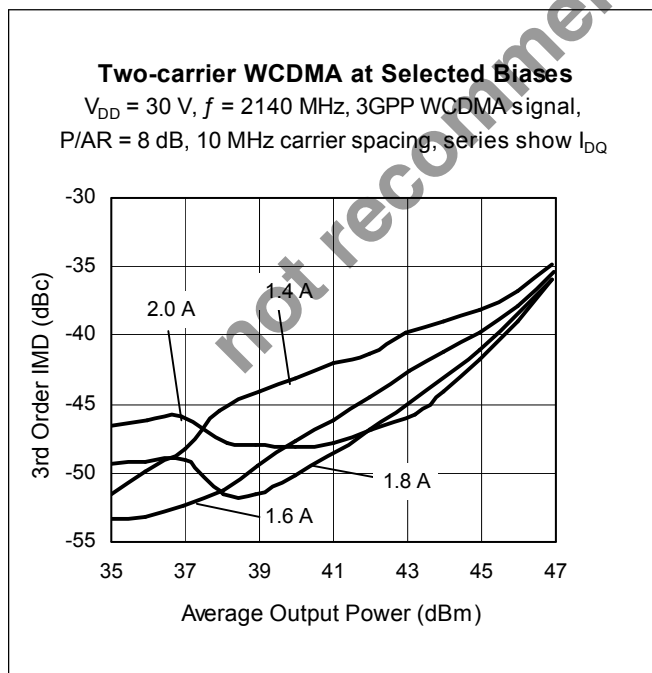

Typical Performance (cont.)

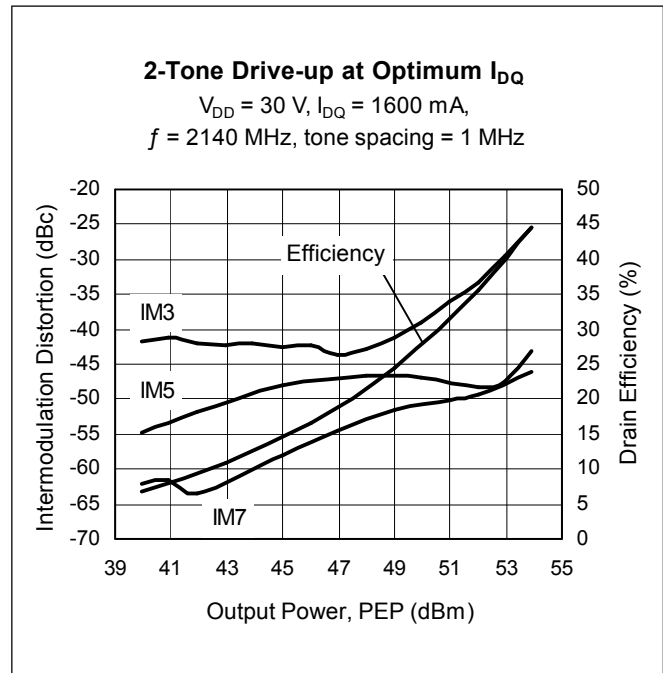
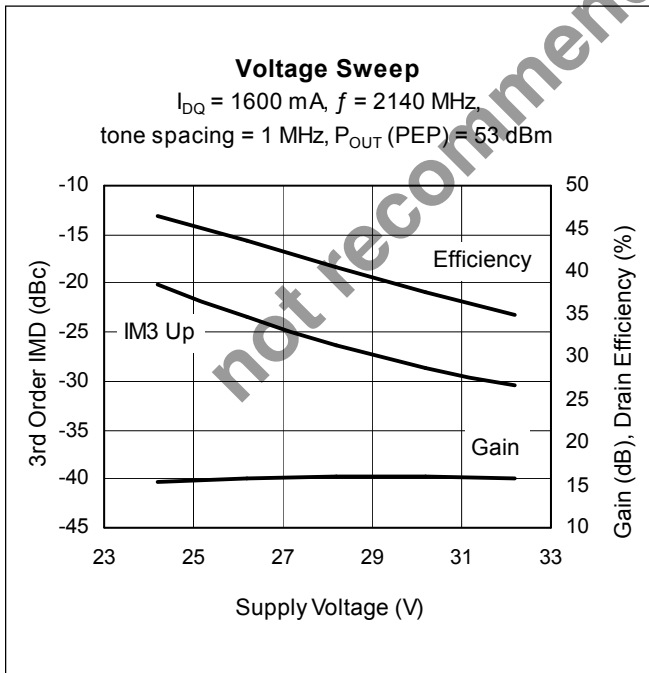
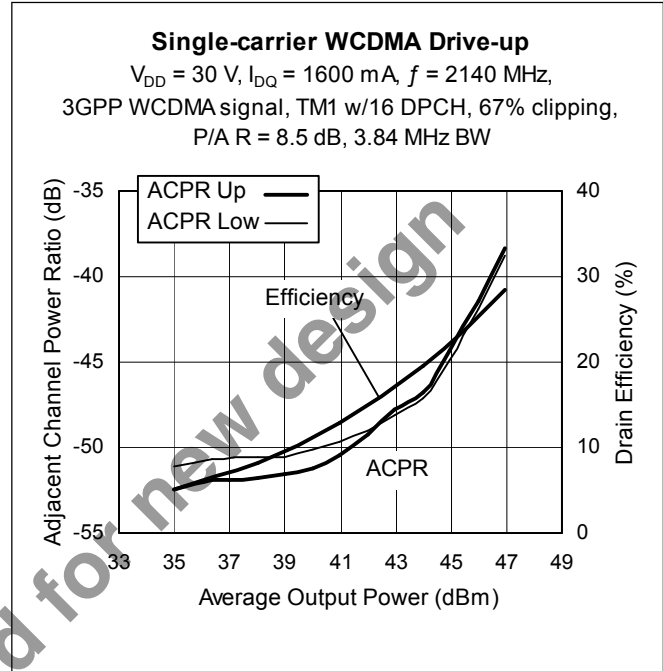
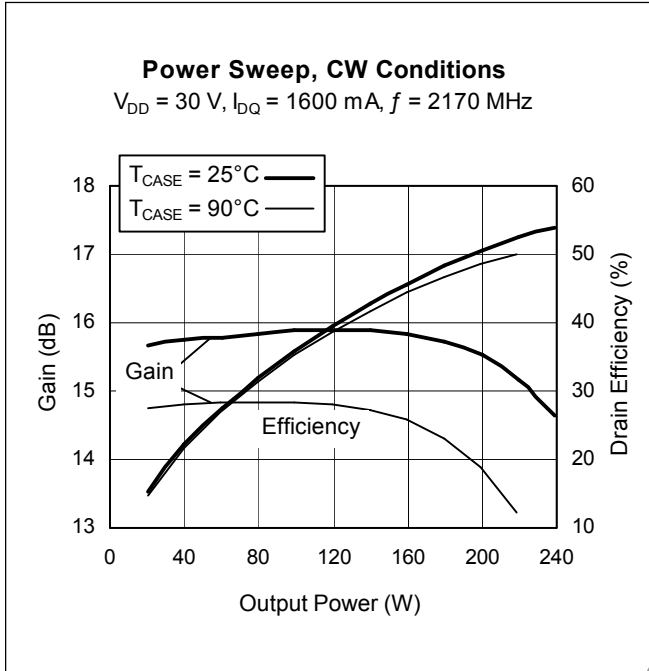

Typical Performance (cont.)

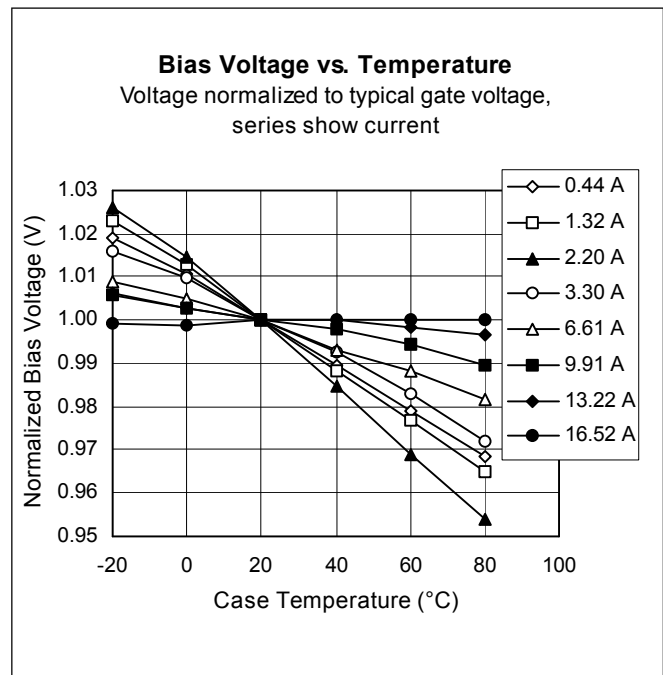
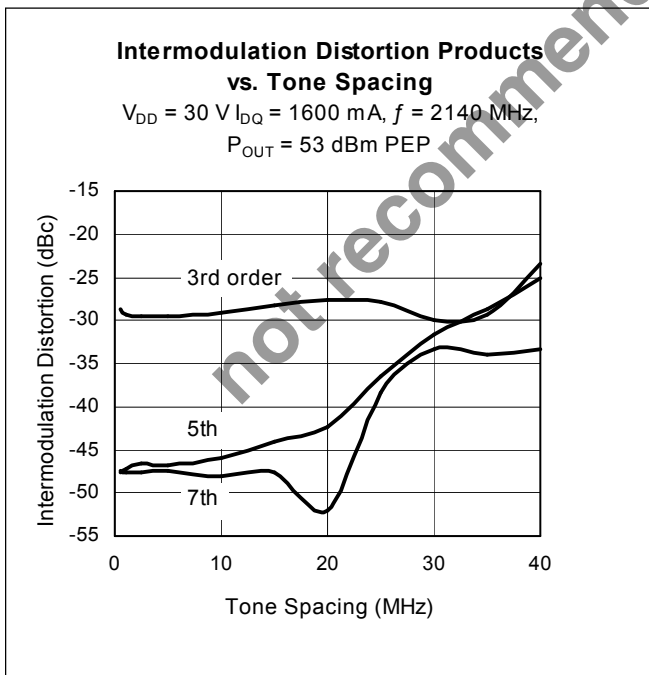
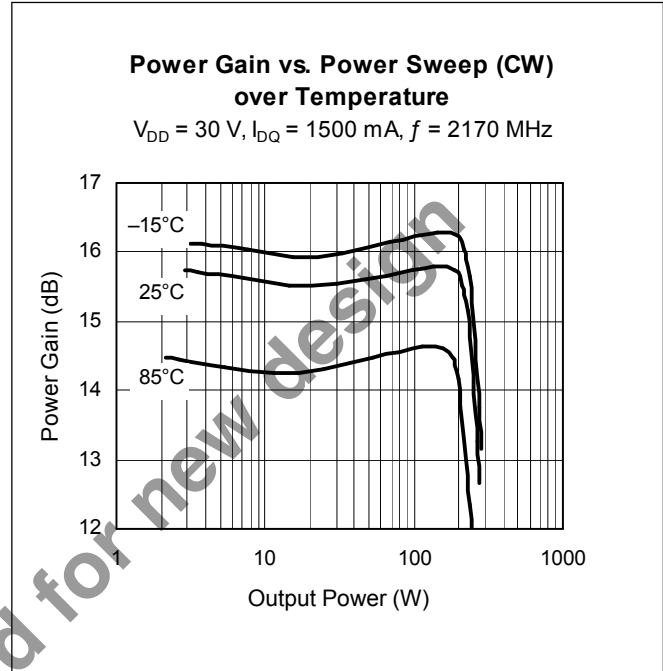
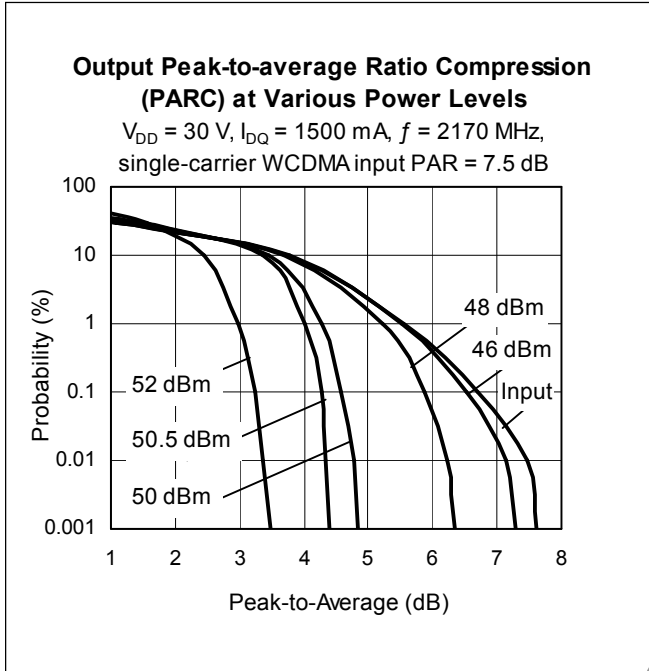

Broadband Circuit Impedance

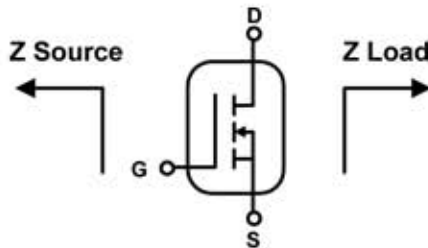

Frequency MHz	Z Source Ω		Z Load Ω	
	R	jX	R	jX
2080	18.2	4.1	1.1	2.5
2110	19.0	3.2	1.0	2.8
2140	19.8	2.3	1.0	3.0
2170	20.4	1.0	1.0	3.2
2200	20.8	-0.6	1.0	3.5

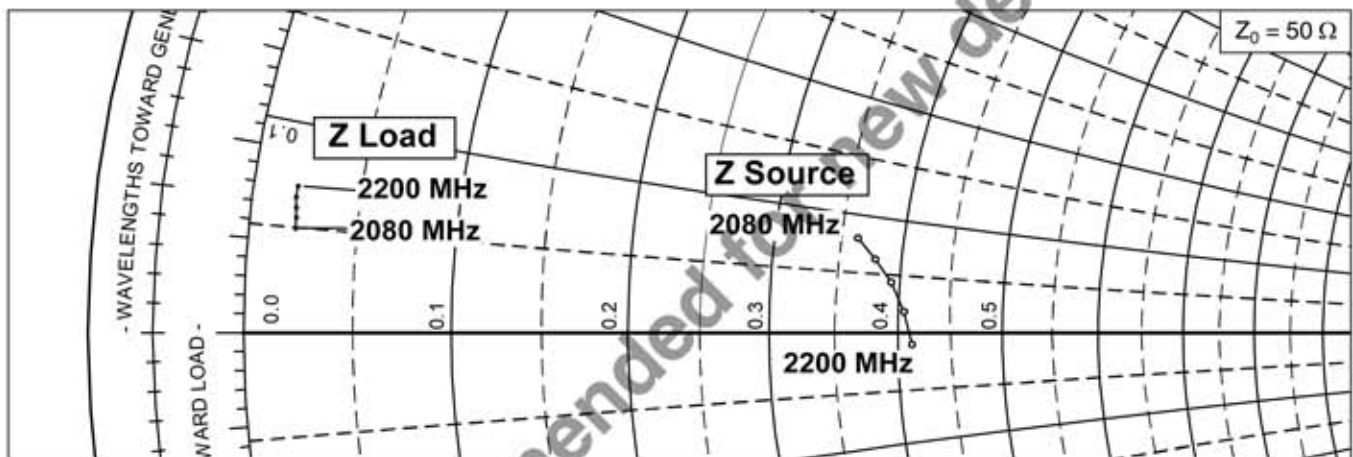

See next page for circuit information

not recommended for new design

Reference Circuit

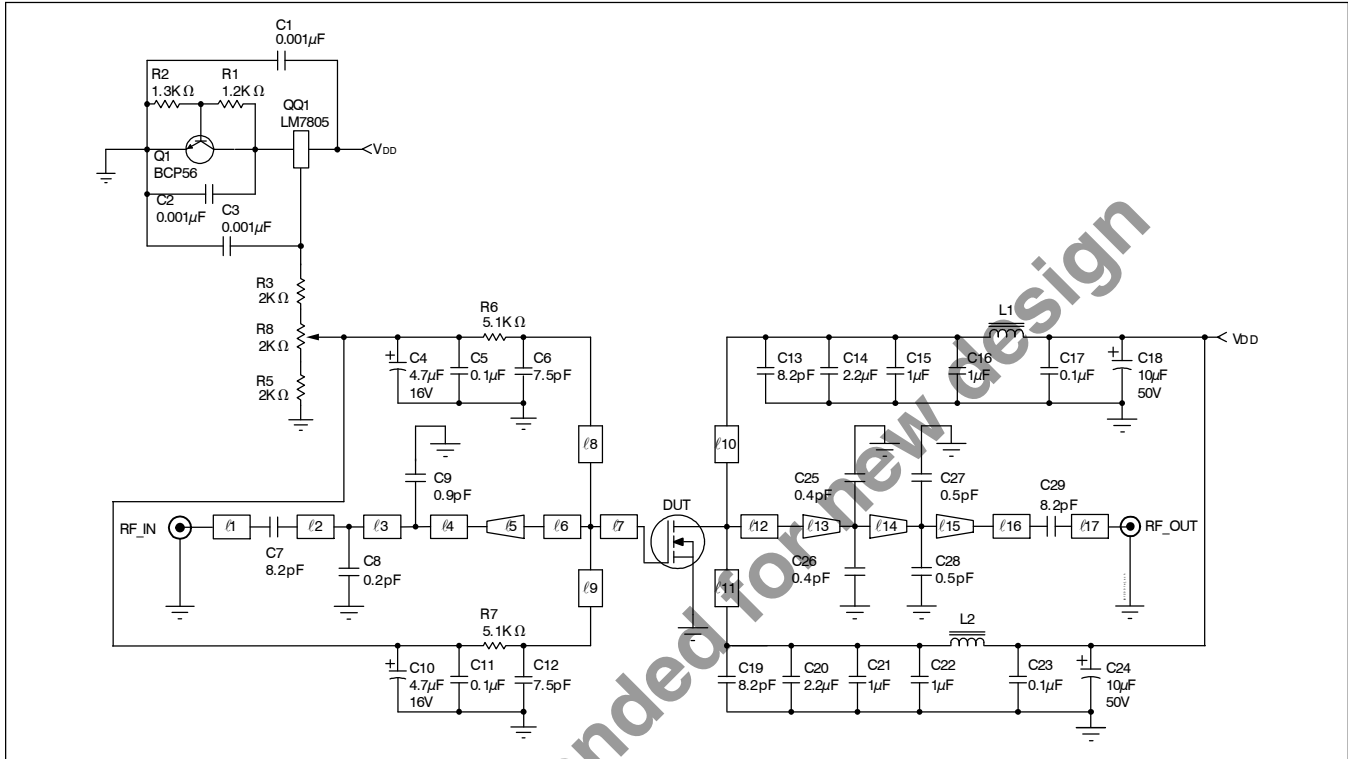

Reference circuit schematic for $f = 2140$ MHz

Circuit Assembly Information

DUT	PTFA212001E or PTFA212001F	LDMOS Transistor	
PCB	0.76 mm [0.030"] thick, $\epsilon_r = 3.48$	Rogers RO4350	1 oz. copper

Microstrip	Electrical Characteristics at 2140 MHz ¹	Dimensions: L x W (mm)	Dimensions: L x W (in.)
l1	0.042 λ , 50.0 Ω	3.56 x 1.68	0.140 x 0.066
l2	0.048 λ , 50.0 Ω	4.11 x 1.68	0.162 x 0.066
l3	0.026 λ , 50.0 Ω	2.08 x 1.68	0.082 x 0.066
l4	0.059 λ , 50.0 Ω	5.03 x 1.68	0.198 x 0.066
l5 (taper)	0.062 λ , 50.0 Ω / 6.9 Ω	5.00 x 1.68 / 20.32	0.197 x 0.066 / 0.800
l6	0.015 λ , 6.9 Ω	1.14 x 20.32	0.045 x 0.800
l7	0.028 λ , 6.9 Ω	2.16 x 20.32	0.085 x 0.800
l8, l9	0.136 λ , 60.0 Ω	11.63 x 1.27	0.458 x 0.050
l10, l11	0.254 λ , 51.2 Ω	21.51 x 1.65	0.847 x 0.065
l12	0.071 λ , 5.0 Ω	5.49 x 28.83	0.216 x 1.135
l13 (taper)	0.019 λ , 5.0 Ω / 6.8 Ω	1.52 x 28.83 / 20.62	0.060 x 1.135 / 0.812
l14 (taper)	0.026 λ , 6.8 Ω / 13.5 Ω	2.11 x 20.62 / 9.65	0.083 x 0.812 / 0.380
l15 (taper)	0.026 λ , 13.5 Ω / 40.9 Ω	2.06 x 9.65 / 2.34	0.081 x 0.380 / 0.092
l16	0.029 λ , 40.9 Ω	2.77 x 2.34	0.109 x 0.092
l17	0.107 λ , 50.0 Ω	9.04 x 1.68	0.356 x 0.066

¹Electrical characteristics are rounded.

Reference Circuit (cont.)

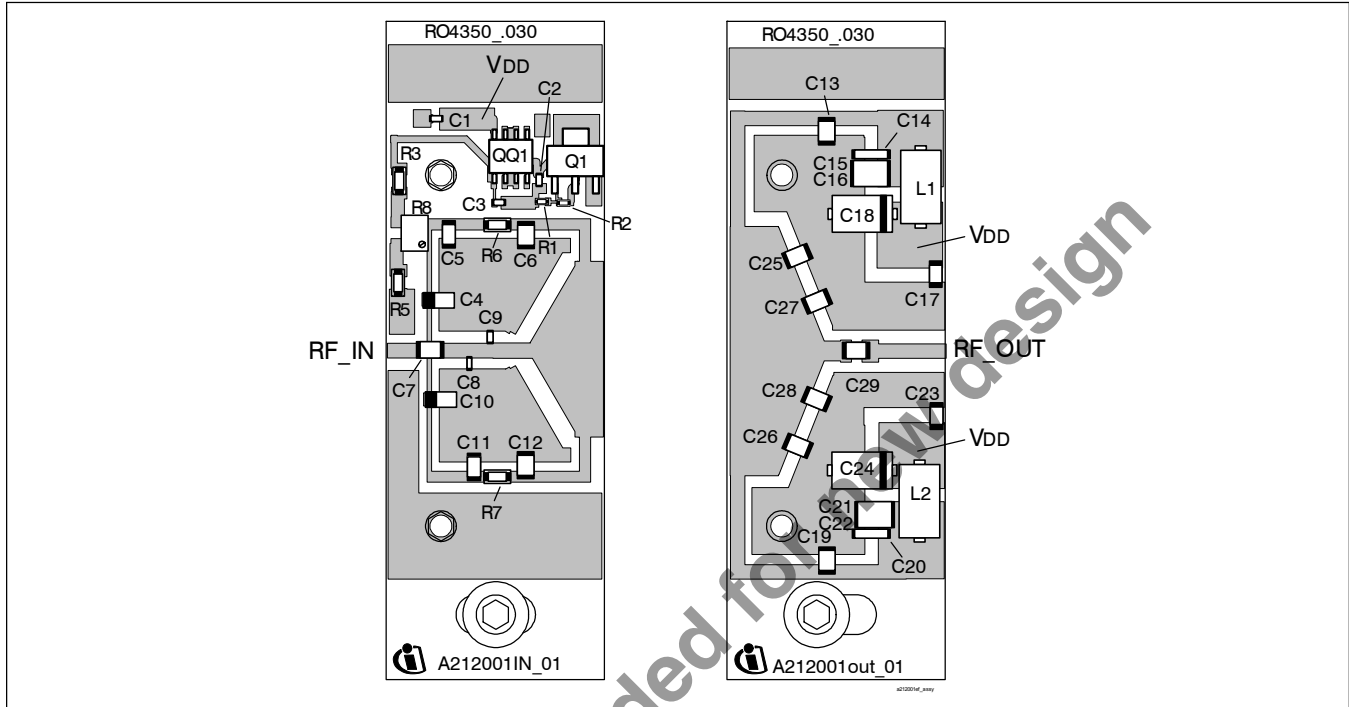

Reference circuit assembly diagram* (not to scale)

Component	Description	Suggested Manufacturer	P/N or Comment
C1, C2, C3	Capacitor, 0.001 μ F	Digi-Key	PCC1772CT-ND
C4, C10	Capacitor, 4.7 μ F, 16 V	Digi-Key	PCS3475CT-ND
C5, C11, C17, C23	Capacitor, 0.1 μ F	Digi-Key	PCC104BCT-ND
C6, C12	Ceramic capacitor, 7.5 pF	ATC	100B 7R5
C7, C13, C19, C29	Ceramic capacitor, 8.2 pF	ATC	100B 8R2
C8	Ceramic capacitor, 0.2 pF	ATC	600S 0R2 BT
C9	Ceramic capacitor, 0.9 pF	ATC	600A 0R9 BT
C14, C20	Capacitor, 2.2 μ F	Digi-Key	445-1474-2-ND
C15, C16, C21, C22	Ceramic capacitor, 1 μ F	Digi-Key	445-1411-2-ND
C18, C24	Tantalum capacitor, 10 μ F, 50 V	Garrett Electronics	TPSE106K050R0400
C25, C26	Ceramic capacitor, 0.4 pF	ATC	100B 0R4
C27, C28	Ceramic capacitor, 0.5 pF	ATC	100B 0R5
L1, L2	Ferrite, 8.9 mm	Elna Magnetics	BDS 4.6/3/8.9-4S2
Q1	Transistor	Infineon Technologies	BCP56
QQ1	Voltage regulator	National Semiconductor	LM7805
R1	Chip resistor 1.2 k-ohms	Digi-Key	P1.2KGCT-ND
R2	Chip resistor 1.3 k-ohms	Digi-Key	P1.3KGCT-ND
R3, R5	Chip resistor 2 k-ohms	Digi-Key	P2KECT-ND
R4	not used		
R6, R7	Chip resistor 5.1 k-ohms	Digi-Key	P5.1KECT-ND
R8	Potentiometer 2 k-ohms	Digi-Key	3224W-202ETR-ND

* Gerber Files for this circuit available on request

Package Outline Specifications (cont.)

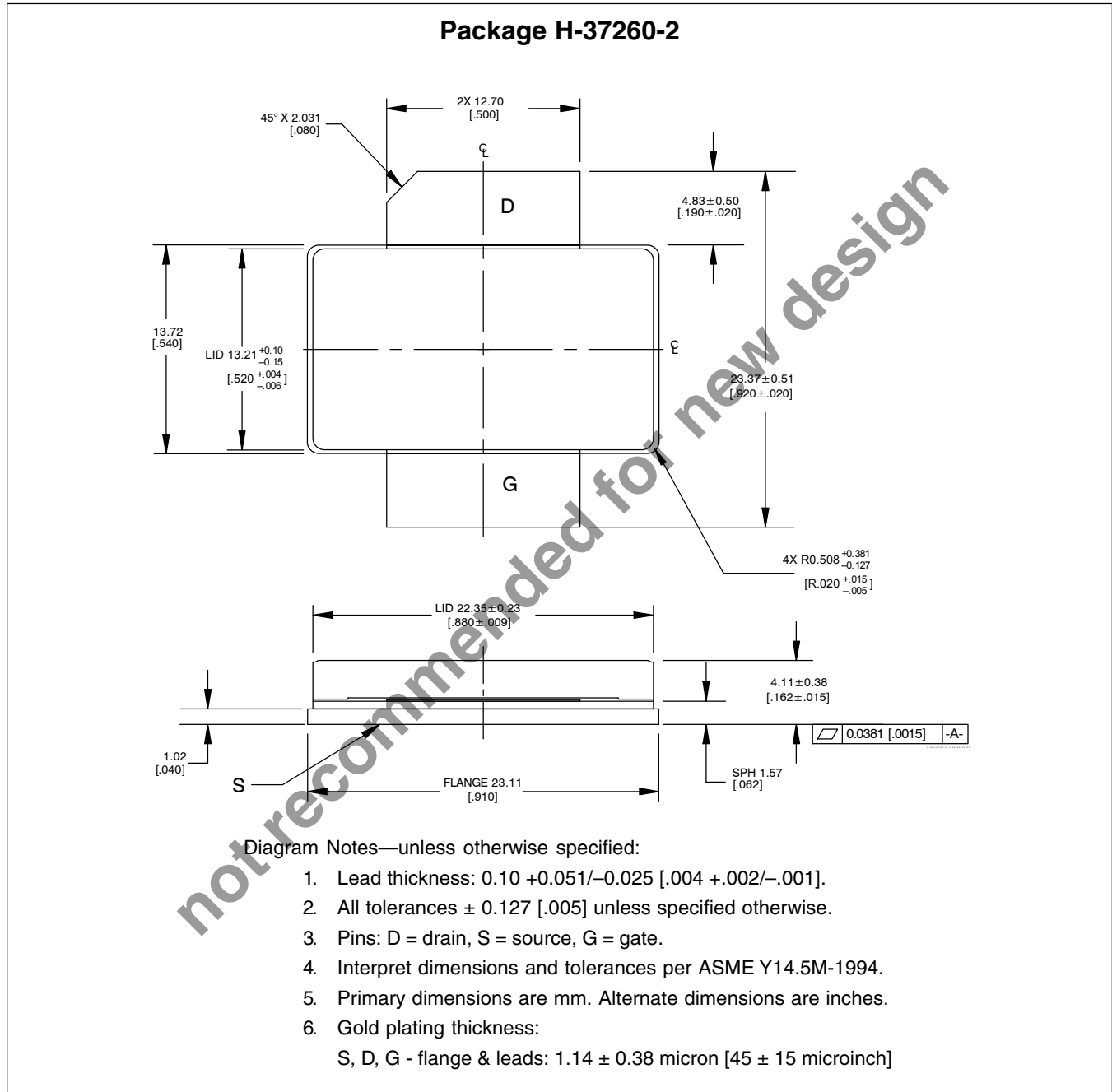

Find the latest and most complete information about products and packaging at the Infineon Internet page
<http://www.infineon.com/rfpower>

Revision History: 2015-03-03

Data Sheet

Previous Version: 2009-02-24, Data Sheet

Page	Subjects (major changes since last revision)
All	Not recommended for new design.

We Listen to Your Comments

Any information within this document that you feel is wrong, unclear or missing at all?
Your feedback will help us to continuously improve the quality of this document.
Please send your proposal (including a reference to this document) to:

highpowerRF@infineon.com

To request other information, contact us at:
+1 877 465 3667 (1-877-GO-LDMOS) USA
or +1 408 776 0600 International

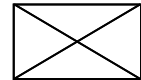

Edition 2015-03-03

Published by

Infineon Technologies AG
81726 Munich, Germany

© 2009 Infineon Technologies AG
All Rights Reserved.

Legal Disclaimer

The information given in this document shall in no event be regarded as a guarantee of conditions or characteristics. With respect to any examples or hints given herein, any typical values stated herein and/or any information regarding the application of the device, Infineon Technologies hereby disclaims any and all warranties and liabilities of any kind, including without limitation, warranties of non-infringement of intellectual property rights of any third party.

Information

For further information on technology, delivery terms and conditions and prices, please contact the nearest Infineon Technologies Office (www.infineon.com/rfpower).

Warnings

Due to technical requirements, components may contain dangerous substances. For information on the types in question, please contact the nearest Infineon Technologies Office.

Infineon Technologies components may be used in life-support devices or systems only with the express written approval of Infineon Technologies, if a failure of such components can reasonably be expected to cause the failure of that life-support device or system or to affect the safety or effectiveness of that device or system. Life support devices or systems are intended to be implanted in the human body or to support and/or maintain and sustain and/or protect human life. If they fail, it is reasonable to assume that the health of the user or other persons may be endangered.