

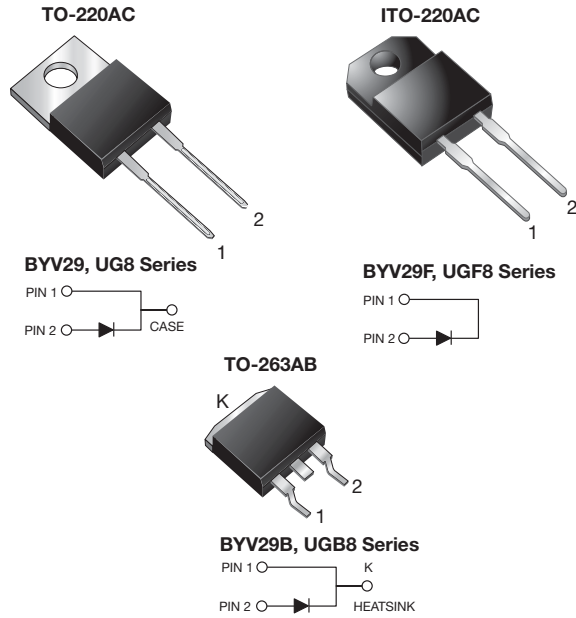

Ultrafast Rectifier



FEATURES

- Power pack
- Glass passivated pallet chip junction
- Ultrafast recovery time
- Low switching losses, high efficiency
- Low forward voltage drop
- High forward surge capability
- Meets MSL level 1, per J-STD-020, LF maximum peak of 245 °C (for TO-263AB package)
- Solder dip 275 °C max. 10 s, per JESD 22-B106 (for TO-220AC and ITO-220AC package)
- AEC-Q101 qualified
- Material categorization: for definitions of compliance please see www.vishay.com/doc?99912

**RoHS**
COMPLIANT

TYPICAL APPLICATIONS

For use in high frequency rectifier of switching mode power supplies, inverters, freewheeling diodes, DC/DC converters, and other power switching application.

PRIMARY CHARACTERISTICS

$I_{F(AV)}$	8.0 A
V_{RRM}	300 V to 400 V
I_{FSM}	110 A
t_{rr}	35 ns
V_F	1.03 V
T_J max.	150 °C
Package	TO-220AC, ITO-220AC, TO-263AB
Diode variations	Single die

MECHANICAL DATA

Case: TO-220AC, ITO-220AC, TO-263AB

Molding compound meets UL 94 V-0 flammability rating
Base P/N-E3 - RoHS-compliant, commercial grade
Base P/NHE3 - RoHS-compliant, AEC-Q101 qualified

Terminals: Matte tin plated leads, solderable per J-STD-002 and JESD 22-B102

E3 suffix meets JESD 201 class 2 whisker test, HE3 suffix meets JESD 201 class 2 whisker test

Polarity: As marked

Mounting Torque: 10 in-lbs max.

MAXIMUM RATINGS ($T_C = 25$ °C unless otherwise noted)

PARAMETER	SYMBOL	BYV29-300	BYV29-400	UNIT
		UG8FT	UG8GT	
Maximum repetitive peak reverse voltage	V_{RRM}	300	400	V
Maximum working reverse voltage	V_{RWM}	300	400	V
Maximum RMS voltage	V_{RMS}	210	280	V
Maximum DC blocking voltage	V_{DC}	300	400	V
Maximum average forward rectified current at $T_C = 100$ °C	$I_{F(AV)}$	8.0		A
Peak forward surge current 8.3 ms single half sine-wave superimposed on rated load	I_{FSM}	110		A
Operating junction and storage temperature range	T_J, T_{STG}	-40 to +150		°C
Isolation voltage (ITO-220AC only) from terminal to heatsink $t = 1$ min	V_{AC}	1500		V



ELECTRICAL CHARACTERISTICS ($T_C = 25\text{ }^\circ\text{C}$ unless otherwise noted)						
PARAMETER	TEST CONDITIONS		SYMBOL	BYV29-300 UG8FT	BYV29-400 UG8GT	UNIT
Maximum instantaneous forward voltage	$I_F = 8\text{ A}$	$T_J = 25\text{ }^\circ\text{C}$	V_F ⁽¹⁾	1.25		V
		$T_J = 150\text{ }^\circ\text{C}$		1.03		
	$I_F = 20\text{ A}$	$T_J = 25\text{ }^\circ\text{C}$		1.40		
Maximum DC reverse current at V_{RRM}			I_R	$T_C = 25\text{ }^\circ\text{C}$		10
				$T_C = 100\text{ }^\circ\text{C}$		350
Maximum reverse recovery time	$I_F = 0.5\text{ A}, I_R = 1.0\text{ A}, I_{rr} = 0.25\text{ A}$		t_{rr}			35
Maximum reverse recovery time	$I_F = 1.0\text{ A}, di/dt = 100\text{ A}/\mu\text{s}, V_R = 30\text{ V}, I_{rr} = 0.1 I_{RM}$		t_{rr}			50
Maximum reverse recovery current	$I_F = 10\text{ A}, di/dt = 50\text{ A}/\mu\text{s}, V_R = 30\text{ V}, T_C = 100\text{ }^\circ\text{C}$		I_{RM}			5.5
Maximum recovered stored charged	$I_F = 2\text{ A}, di/dt = 20\text{ A}/\mu\text{s}, V_R = 30\text{ V}, I_{rr} = 0.1 I_{RM}$		Q_{rr}			55

Note

⁽¹⁾ Pulse test: 300 μs pulse width, 1 % duty cycle

THERMAL CHARACTERISTICS ($T_C = 25\text{ }^\circ\text{C}$ unless otherwise noted)					
PARAMETER	SYMBOL	BYV29 UG8	BYV29F UGF8	BYV29B UGB8	UNIT
Typical thermal resistance from junction to case	$R_{\theta JC}$	2.5	5.5	2.5	$^\circ\text{C}/\text{W}$

ORDERING INFORMATION (Example)					
PACKAGE	PREFERRED P/N	UNIT WEIGHT (g)	PACKAGE CODE	BASE QUANTITY	DELIVERY MODE
TO-220AC	BYV29-400-E3/45	1.80	45	50/tube	Tube
ITO-220AC	BYV29F-400-E3/45	1.95	45	50/tube	Tube
TO-263AB	BYV29B-400-E3/45	1.77	45	50/tube	Tube
TO-263AB	BYV29B-400-E3/81	1.77	81	800/reel	Tape and reel
TO-220AC	BYV29-400HE3/45 ⁽¹⁾	1.80	45	50/tube	Tube
ITO-220AC	BYV29F-400HE3/45 ⁽¹⁾	1.95	45	50/tube	Tube
TO-263AB	BYV29B-400HE3/45 ⁽¹⁾	1.77	45	50/tube	Tube
TO-263AB	BYV29B-400HE3/81 ⁽¹⁾	1.77	81	800/reel	Tape and reel

Note

⁽¹⁾ AEC-Q101 qualified



RATINGS AND CHARACTERISTICS CURVES (T_C = 25 °C unless otherwise noted)

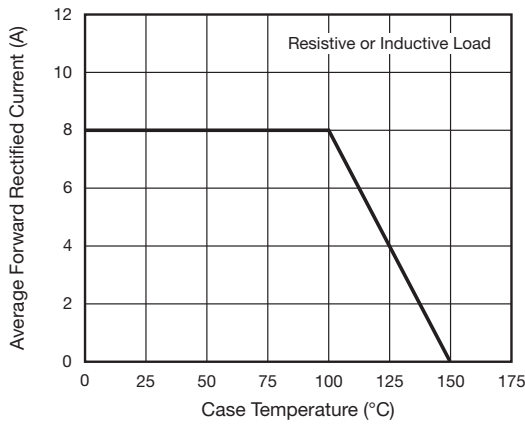

Fig. 1 - Maximum Forward Current Derating Curve

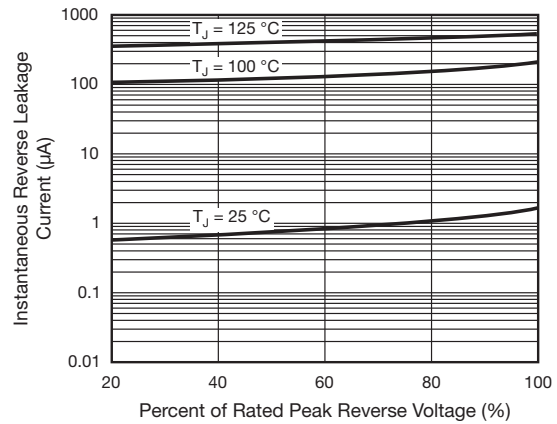

Fig. 4 - Typical Reverse Leakage Characteristics

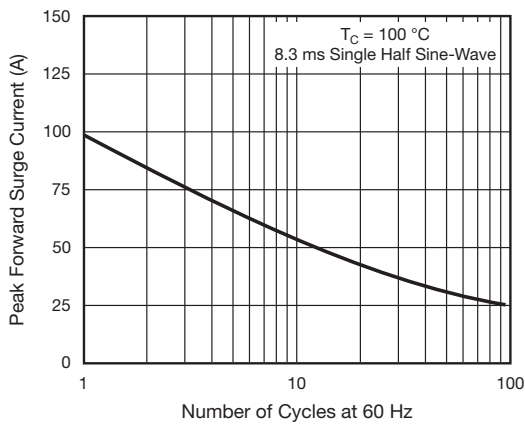

Fig. 2 - Maximum Non-Repetitive Peak Forward Surge Current

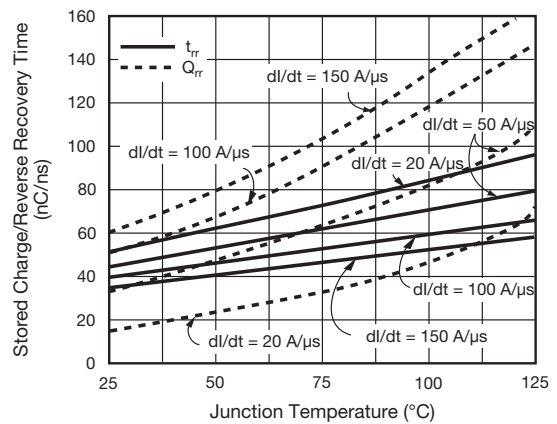

Fig. 5 - Reverse Switching Characteristics Per Leg

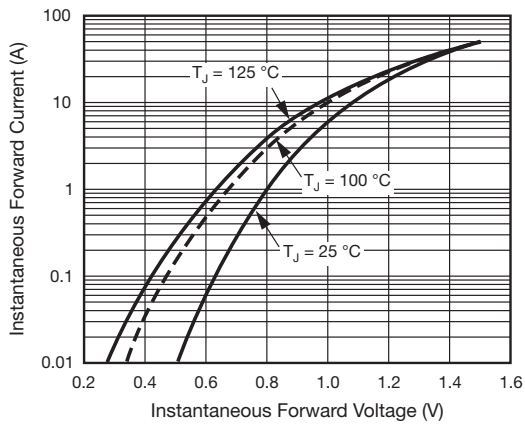

Fig. 3 - Typical Instantaneous Forward Characteristics

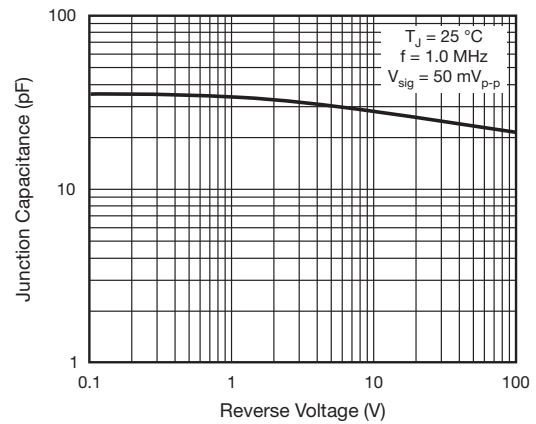
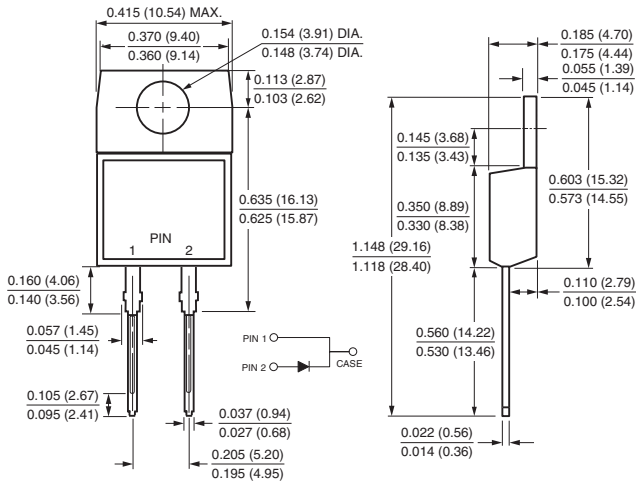

Fig. 6 - Typical Junction Capacitance



PACKAGE OUTLINE DIMENSIONS in inches (millimeters)

TO-220AC



ITO-220AC

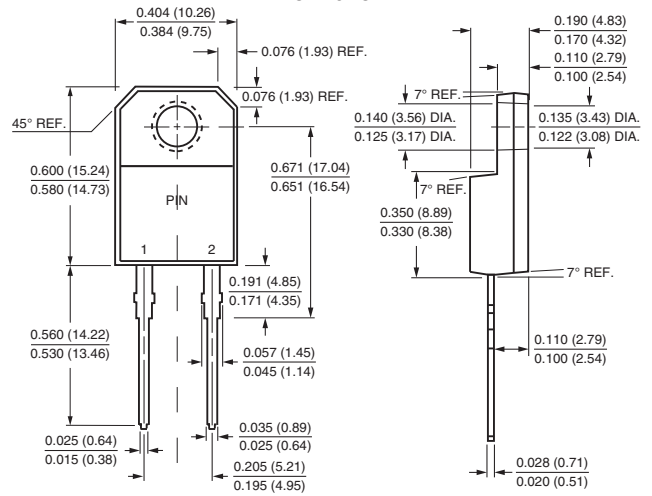

TO-263AB

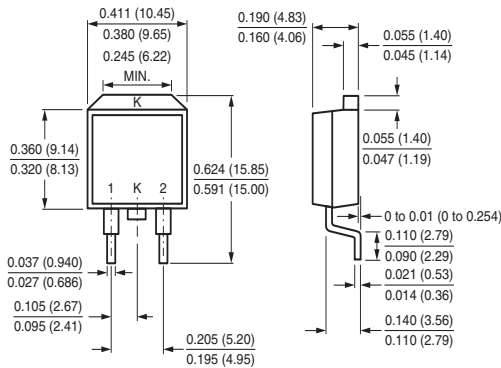

Mounting Pad Layout

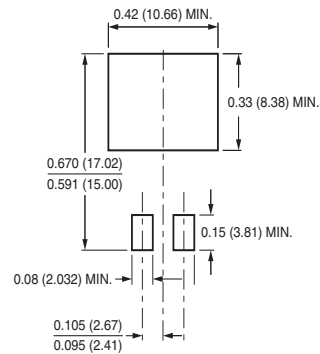



Disclaimer

ALL PRODUCT, PRODUCT SPECIFICATIONS AND DATA ARE SUBJECT TO CHANGE WITHOUT NOTICE TO IMPROVE RELIABILITY, FUNCTION OR DESIGN OR OTHERWISE.

Vishay Intertechnology, Inc., its affiliates, agents, and employees, and all persons acting on its or their behalf (collectively, "Vishay"), disclaim any and all liability for any errors, inaccuracies or incompleteness contained in any datasheet or in any other disclosure relating to any product.

Vishay makes no warranty, representation or guarantee regarding the suitability of the products for any particular purpose or the continuing production of any product. To the maximum extent permitted by applicable law, Vishay disclaims (i) any and all liability arising out of the application or use of any product, (ii) any and all liability, including without limitation special, consequential or incidental damages, and (iii) any and all implied warranties, including warranties of fitness for particular purpose, non-infringement and merchantability.

Statements regarding the suitability of products for certain types of applications are based on Vishay's knowledge of typical requirements that are often placed on Vishay products in generic applications. Such statements are not binding statements about the suitability of products for a particular application. It is the customer's responsibility to validate that a particular product with the properties described in the product specification is suitable for use in a particular application. Parameters provided in datasheets and/or specifications may vary in different applications and performance may vary over time. All operating parameters, including typical parameters, must be validated for each customer application by the customer's technical experts. Product specifications do not expand or otherwise modify Vishay's terms and conditions of purchase, including but not limited to the warranty expressed therein.

Except as expressly indicated in writing, Vishay products are not designed for use in medical, life-saving, or life-sustaining applications or for any other application in which the failure of the Vishay product could result in personal injury or death. Customers using or selling Vishay products not expressly indicated for use in such applications do so at their own risk. Please contact authorized Vishay personnel to obtain written terms and conditions regarding products designed for such applications.

No license, express or implied, by estoppel or otherwise, to any intellectual property rights is granted by this document or by any conduct of Vishay. Product names and markings noted herein may be trademarks of their respective owners.

Material Category Policy

Vishay Intertechnology, Inc. hereby certifies that all its products that are identified as RoHS-Compliant fulfill the definitions and restrictions defined under Directive 2011/65/EU of The European Parliament and of the Council of June 8, 2011 on the restriction of the use of certain hazardous substances in electrical and electronic equipment (EEE) - recast, unless otherwise specified as non-compliant.

Please note that some Vishay documentation may still make reference to RoHS Directive 2002/95/EC. We confirm that all the products identified as being compliant to Directive 2002/95/EC conform to Directive 2011/65/EU.

Vishay Intertechnology, Inc. hereby certifies that all its products that are identified as Halogen-Free follow Halogen-Free requirements as per JEDEC JS709A standards. Please note that some Vishay documentation may still make reference to the IEC 61249-2-21 definition. We confirm that all the products identified as being compliant to IEC 61249-2-21 conform to JEDEC JS709A standards.