

User's Guide

NHD-240128WG-BYGH-VZ#000C

LCM

(Liquid Crystal Display Graphic Module)

RoHS Compliant

NHD-	Newhaven Display
240128-	240 x 128 pixels
WG-	W= Factory Line G= Display Type: Graphic
B-	Model / Serial number
Y-	Yellow/Green LED B/L
G-	STN- Gray
H-	Transflective, 6:00 View, Wide Temperature (-20 ~ +70c)
VZ#-	Built-in Negative voltage; RoHS
000C-	With Angled Pin Header

For product support, contact

Newhaven Display International
2511 Technology Drive, #101
Elgin, IL 60124

Tel: (847) 844-8795 Fax: (847) 844-8796

March 11, 2009

Contents

- 1.Module Classification Information
- 2.Precautions in use of LCD Modules
- 3.General Specification
- 4.Absolute Maximum Ratings
- 5.Electrical Characteristics
- 6.Optical Characteristics
- 7.Power Supply for LCD Module and Contrast Adjust
- 8.Contour Drawing & Block Diagram
- 9.Interface Pin Function
- 10.Display control instruction
- 11.Timing Characteristics
- 12.Quality Assurance
- 13.Reliability
- 14.Backlight Information

1. Module Classification Information

NHD 240128 W G BYGH - VZ#000C
 ① ② ③ ④ ⑤ ⑥ ⑦ ⑧ 9

- ① Brand Newhaven Display
- ② Display Font 240 x 128 Dots
- ③ Factory Line: W
- ④ Display Type H Character Type, **G** Graphic Type, C Color
- ⑤ Model / Serial number = **B**
- ⑥ Backlight Type N Without backlight

B	EL, Blue green	A	LED, Amber
D	EL, Green	R	LED, Red
W	EL, White	O	LED, Orange
F	CCFL, White	G	LED, Green
Y	LED, Yellow Green	T	LED, White
- ⑦ LCD Mode B TN Positive, Gray T FSTN Negative

N	TN Negative,	C	STN Color
G	STN Positive, Gray	F	FSTN Positive
Y	STN Positive, Yellow Green	M	STN Negative, Blue
- ⑧ LCD Polarize Type/
Temperature range/
View direction A Reflective, N.T, 6:00 **H** Transflective, W.T,6:00

D	Reflective, N.T, 12:00	K	Transflective, W.T,12:00
G	Reflective, W. T, 6:00	C	Transmissive, N.T,6:00
J	Reflective, W. T, 12:00	F	Transmissive, N.T,12:00
B	Transflective, N.T,6:00	I	Transmissive, W. T, 6:00
E	Transflective, N.T.12:00	L	Transmissive, W.T,12:00
- 9 Special Code **VZ** : Built-in Negative voltage
 000C : With Angled Pin Header

2. Precautions in use of LCD Modules

- (1) Avoid applying excessive shock to the module or making any alterations or modifications to it.
- (2) Don't make extra holes on the printed circuit board, modify its shape or change the components of LCD module.
- (3) Don't disassemble the LCM.
- (4) Don't operate it above the absolute maximum rating.
- (5) Don't drop, bend or twist LCM.
- (6) Soldering: only to the I/O terminals.
- (7) Storage: please store in anti-static electricity container and clean environment.

3. General Specification

NHD-240128WG-BYGH-VZ#000C

ITEM	STANDARD VALUE	UNIT
Number of Dots:	240 ×128	
Module dimension:	144.0×104.0×14.3(MAX)mm	mm
View area:	114.0×64.0mm	mm
Active area:	107.98×57.58mm	mm
Character size:	(L)0.43×(W)0.43 mm	mm
Character pitch:	(L)0.45×(W)0.45mm	mm
LCD type:	STN-GRAY , Positive , Transflective ,	
Duty:	1/128	
View direction:	6 o'clock	
Backlight:	LED ,Yellow/Green	

4. Absolute Maximum Ratings

ITEM	SYMBOL	MIN.	TYP.	MAX.	UNIT
Operating Temperature	T _{OP}	-20		+70	
Storage Temperature	T _{ST}	-30		+80	
Input Voltage	V _I	V _{SS}		V _{DD}	V
Supply Voltage For Logic	V _{DD} -V _{SS}	-0.3		+7	V
Supply Voltage For LCD	V _{DD} -V ₀	0		21	V
LED forward current	I _{LED}			150	mA

5. Electrical Characteristics

ITEM	SYMBOL	CONDITION	MIN.	TYP.	MAX.	UNIT
Supply Voltage For Logic	V _{DD} -V _{SS}		4.75	5.0	5.25	V
Supply Voltage For LCD	V _{DD} -V ₀	T _a =-20			21.7	V
		T _a =25		19.5		V
		T _a =+70	17.8			V
Input High Vol	V _{IH}		V _{DD} -2.2		V _{DD}	V
Input Low Vol	V _{IL}		0		0.8	V
Output High Vol	V _{OH}		V _{DD} -0.3		V _{DD}	V
Output Low Vol.	V _{OL}		0		0.3	V
Supply Current	I _{DD}	V _{DD} =5V	45	55	60	mA

6. Optical Characteristics

ITEM	SYMBAL	CONDITION	MIN.	TYP.	MAX.	UNIT
View Angle	(V)	CR 2	30		60	deg
	(H)	CR 2	-45		45	deg
Contrast Ratio	CR			5		
Response Time	T rise			150	200	ms
	T fall			150	200	ms

6.1 Definitions

■ View Angles

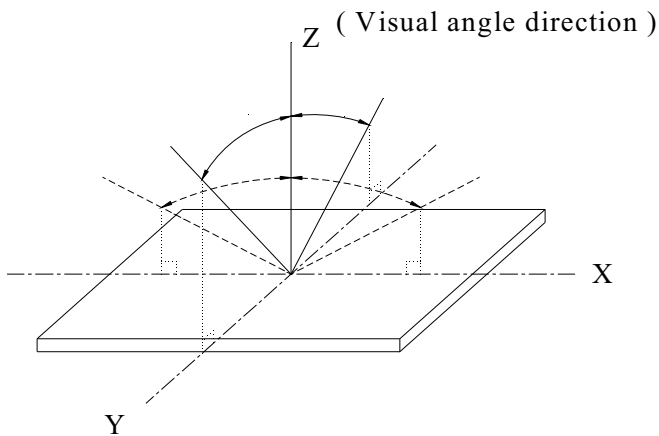

■ Contrast Ratio

$$CR = \frac{\text{Brightness at selected state (BS)}}{\text{Brightness at non-selected state (Bns)}}$$

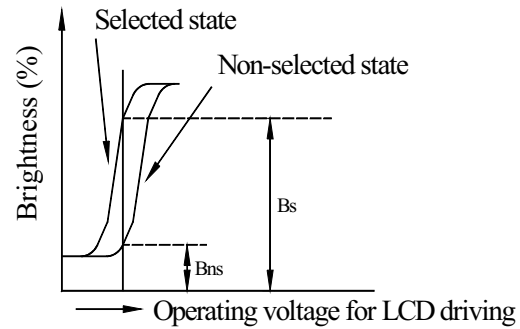

7. Power Supply for LCD Module and Contrast Adjust

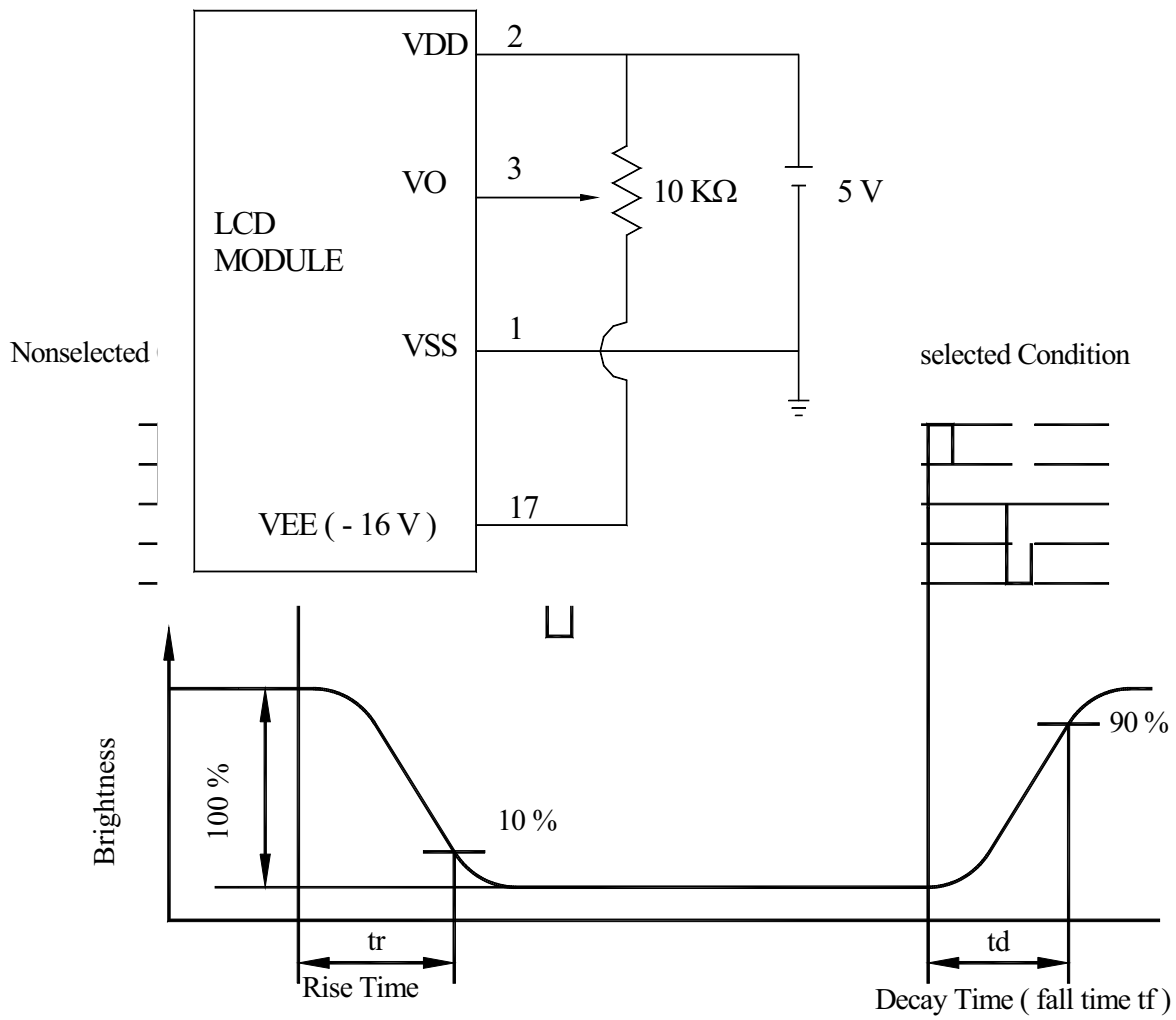

VDD-V0: LCD Operating Voltage (at 25°C)

8. Contour Drawing & Block Diagram

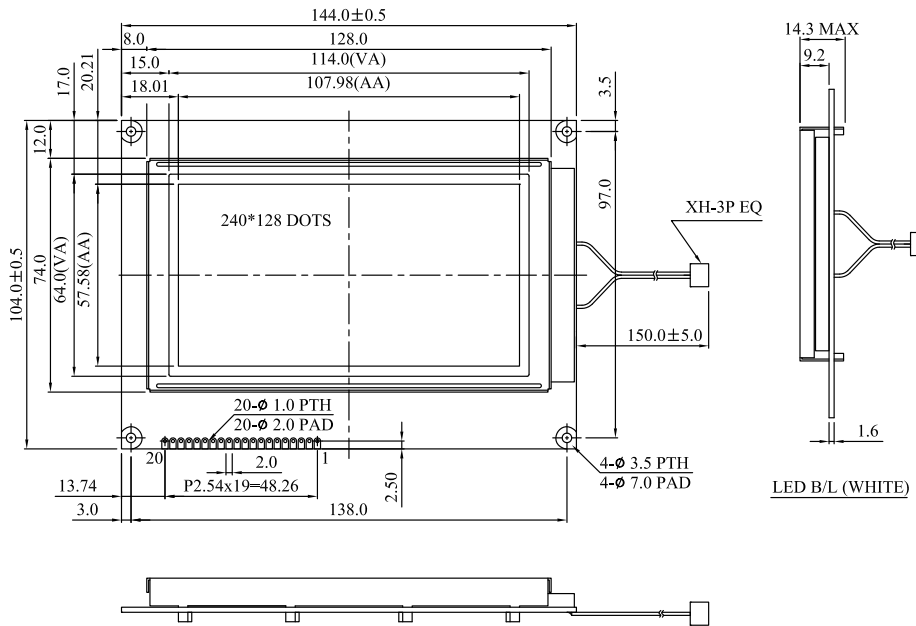

PIN NO.	SYMBOL
1	Vss
2	Vdd
3	Vo
4	C/D
5	RD
6	WR
7	DB0
8	DB1
9	DB2
10	DB3
11	DB4
12	DB5
13	DB6
14	DB7
15	CE
16	RESET
17	Vee
18	MD2
19	FS1
20	NC

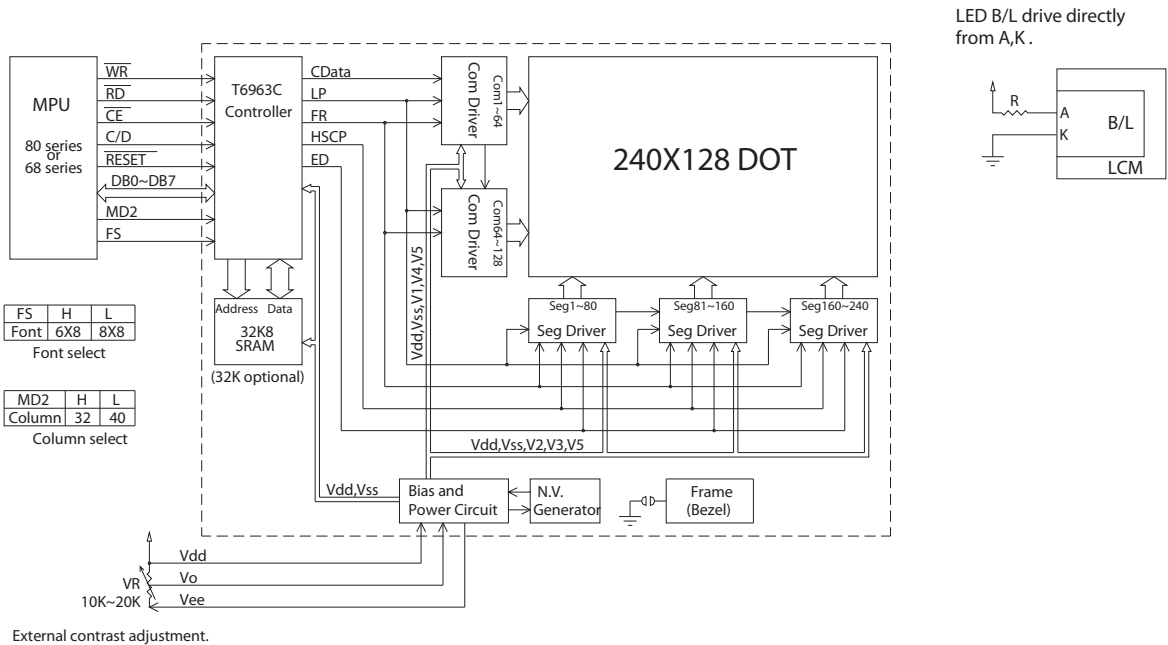
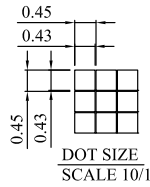

9. Interface Pin Function

Pin No.	Symbol	Level	Description
1	Vss		GND
2	Vdd		Power supply (+5 V)
3	Vo		Power supply for LCD driver
4	C/D	H / L	WR=L , C/D=H : Command Write C/D=L: Data write RD=L , C/D=H : Status Read C/D=L: Data read
5	RD	L	Data read. Read data from T6963C when RD = L
6	WR	L	Data write. Write data into T6963C when WR = L
7	DB0	H / L	Data bus line
8	DB1	H / L	Data bus line
9	DB2	H / L	Data bus line
10	DB3	H / L	Data bus line
11	DB4	H / L	Data bus line
12	DB5	H / L	Data bus line
13	DB6	H / L	Data bus line
14	DB7	H / L	Data bus line
15	CE	L	L : Chip enable
16	RESET	H / L	H : Normal ; L : Initialize T6963C
17	Vee		Negative Voltage Output (-16V)
18	MD2	H / L	H: 32 columns ; L: 40 columns
19	FS	H / L	Pins for selection of font ; H : 6 * 8 , L : 8 * 8

20	N.C		No connection
----	-----	--	---------------

10. Display control instruction

The LCD Module has built in a T6963C LSI controller, It has an 8-bit parallel data bus and control lines for writing or reading through an MPU interface, it has a 128-word character generator ROM (refer to Table 1.), which can control an external display RAM of up to 8K bytes. Allocation of text, graphics and external character generator RAM can be made easily and the display window can be moved freely within the allocated memory range.

•RAM Interface

The external RAM is used to store display data (text, graphic and external CG data). It can be freely allocated to the memory area (8 Kbyte max).

Recommend

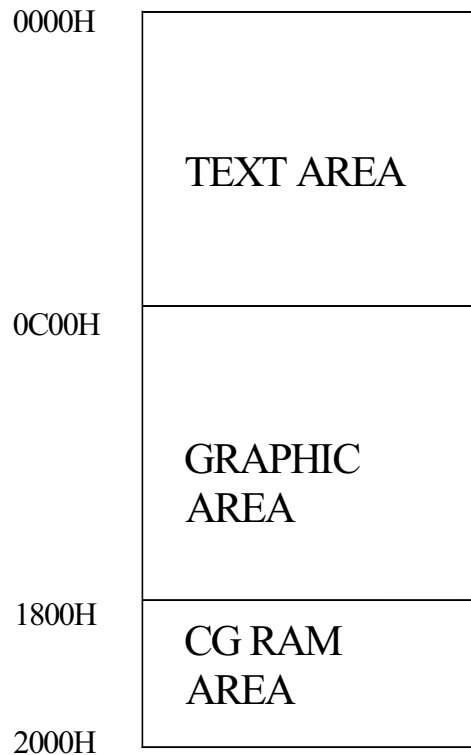

Flowchart of communications with MPU

(1)Status Read

A status check must be performed before data is read or written.

Status check

The Status of T6963C can be read from the data lines.

\overline{RD}	L
\overline{WR}	H
\overline{CE}	L
C/D	H
Do to D7	H

The T6963C status word format is as follows:

MSB				LSB			
STA7	STA6	STA5	STA4	STA3	STA2	STA1	STA0
D7	D6	D5	D4	D3	D2	D1	D0

STA0	Check command execution capability	0:Disable 1:Enable
STA1	Check data read/write Capability	0:Disable 1:Enable
STA2	Check Auto mode data read capability	0:Disable 1:Enable
STA3	Check Auto mode data write capability	0:Disable 1:Enable
STA4	Not used	
STA5	Check controller operation capability	0:Disable 1:Enable
STA6	Error flag. Used for Screen Peek and Screen copy commands.	0:No error 1>Error
STA7	Check the blink condition	0:Disable off 1:Normal display

(Note 1) It is necessary to check STA0 and STA1 at the same time.

There is a possibility of erroneous operation due to a hardware interrupt.

(Note 2) For most modes STA0/STA1 are used as a status check.

(Note 3) STA2 and STA3 are valid in Auto mode; STA0 and STA1 are invalid.

Status Checking flow

(a)

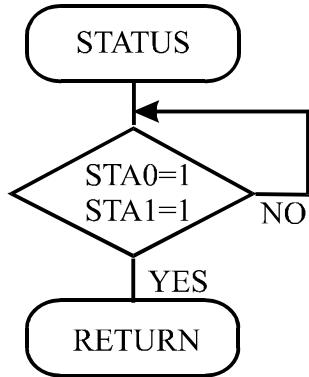

(b)

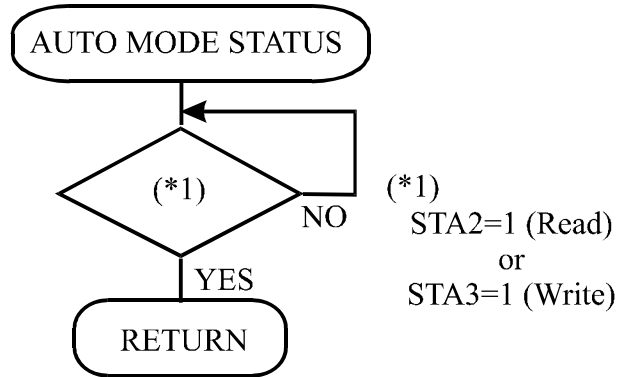

(Note 4) When using the MSB=0 command, a Status Read must be performed.

If a status check is not carried out, the T6963C cannot operate normally, even after a delay time.

The hardware interrupt occurs during the address calculation period (at the end of each line).

If a MSB=0 command is sent to the T6963C during this period, the T6963C enters Wait status.

If a status check is not carried out in this state before the next command is sent, there is the possibility that the command or data date will not be received.

(2)Setting date

When using the T6963C, first set the data, then set the command.

Procedure for sending a command

(a)The case of 1 date

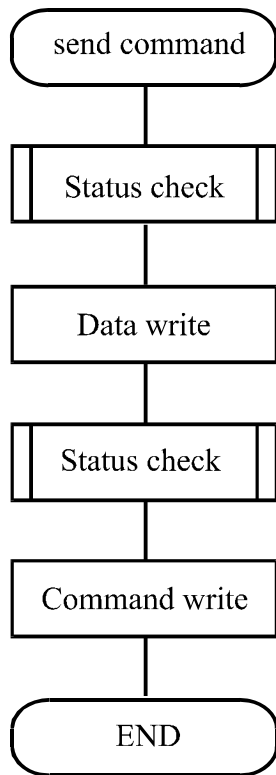

(b)The case of 2 data

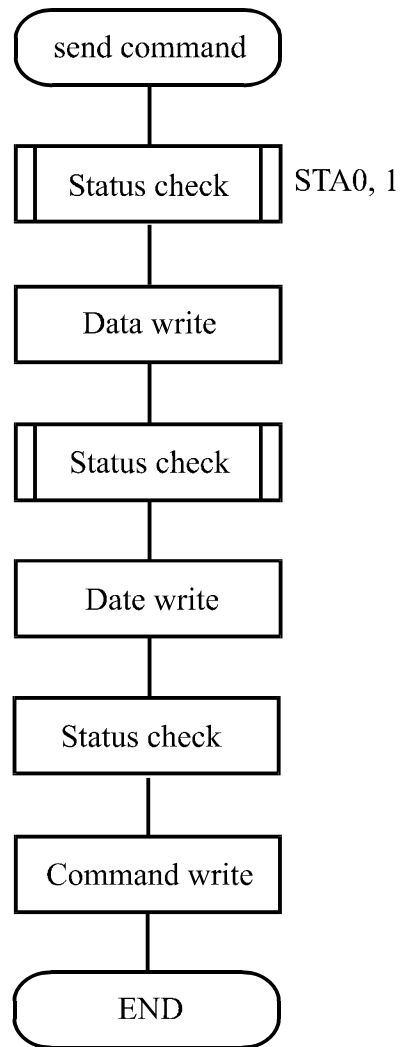

(Note) When sending more than two data, the last datum (or last two data)is valid.

COMMAND DEFINITIONS

COMMAND	CODE	D1	D2	FUNCTION
REGISTERS SETTING	00100001	X address	Y address	Set Cursor Pointer
	00100010	Date	00H	Set Offset Register
	00100100	Low address	High address	Set Address Pointer
SET CONTROL WORD	01000000	Low address	High address	Set Text Home Address
	01000001	Columns	00H	Set Text Area
	01000010	Low address	High address	Set Graphic Home Address
	01000011	Columns	00H	Set Graphic Area
MODE SET	1000×000			OR mode
	1000×001			EXOR mode
	1000×011			AND mode
	1000×100			Text Attribute mode
	10000×××			Internal CG ROM mode
	10001×××			External CG RAM mode
DISPLAY MODE	10010000			Display off
	1001××10			Cursor on, blink off
	10001××11			Cursor on, blink on
	100101××			Text on, graphic off
	100110××			Text off, graphic on
	100111××			Text on, graphic on
CURSOR PATTERN SELECT	10100000			1-line cursor
	10100001			2-line cursor
	10100010			3-line cursor
	10100011			4-line cursor
	10100100			5-line cursor
	10100101			6-line cursor
	10100110			7-line cursor
	10100111			8-line cursor
DATA AUTO READ/WRITE	10110000			Set Data Auto Write
	10110001			Set Data Auto Read
	10110010			Auto Reset
DATA READ/WRITE	11000000	Data		Data Write and Increment ADP
	11000001			Data Read and Increment ADP
	11000010	Data		Data Write and Decrement ADP
	11000011			Data Read and Decrement ADP
	11000100	Data		Data Write and Non-variable ADP
	11000101			Data Read and Non-variable ADP
SCREEN PEEK	11100000			Screen Peek
SCREEN COPY	11101000			Screen Copy
BIT SET/RESET	11110×××			Bit Reset
	11111×××			Bit Set
	1111×000			Bit 0 (LSB)
	11111×001			Bit 1
	11111×010			Bit 2
	11111×011			Bit 3
	11111×100			Bit 4
	11111×101			Bit 5

	11111×110			Bit 6
	11111×111			Bit 7 (MSB)

X: invalid

Setting registers

CODE	HEX.	FUNCTION	D1	D2
00100001	21H	SET CURSOR POINTER	X ADRS	Y ADRS
00100010	23H	SET OFFSET REGISTER	DATA	00H
00100100	24H	SET ADDRESS POINTER	LOW ADRS	HIGH ADRS

(1)Set Cursor Pointer

The position of the cursor is specified by X ADRS and Y ADRS. The cursor position can only be moved by this command. Data read/write from the MPU never changes the cursor pointer. X ADRS and Y ADRS are specified as follows.

X ADRS 00H to 4FH (lower 7 bits are valid)

Y ADRS 00H to 1FH (lower 5 bits are valid)

Single-Scan

X ADRS 00 to 4FH

Y ADRS 00H to 0FH

(2)Set Offset Register

The offset register is used to determine the external character generator RAM area.

The T6963C has a 16-bit address bus as follows.

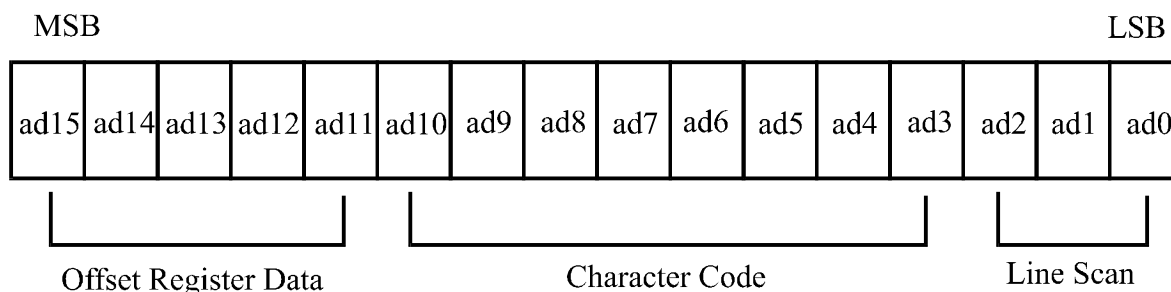

characters. In external CG ROM mode, all 256 codes from 00H to FFH can be used to represent the user's own characters. The three least significant bits indicate one of the eight rows of eight dots that define the character's shape.

The relationship between display RAM address and offset register

Offset register data	CG RAM hex. address (start to end)
00000	0000 to 07 FFH
00001	0800 to 0FFFH
00010	1000 to 17FFH
11100	E000 to E7FFH
11101	E800 to EFFFH
11110	F000 to F7FFH
11111	F800 to FFFFH

(Example 1)

Offset register	02H
Character code	80H
Character generator RAM start address	0001 0100 0000 0000
	1 4 0 0 H

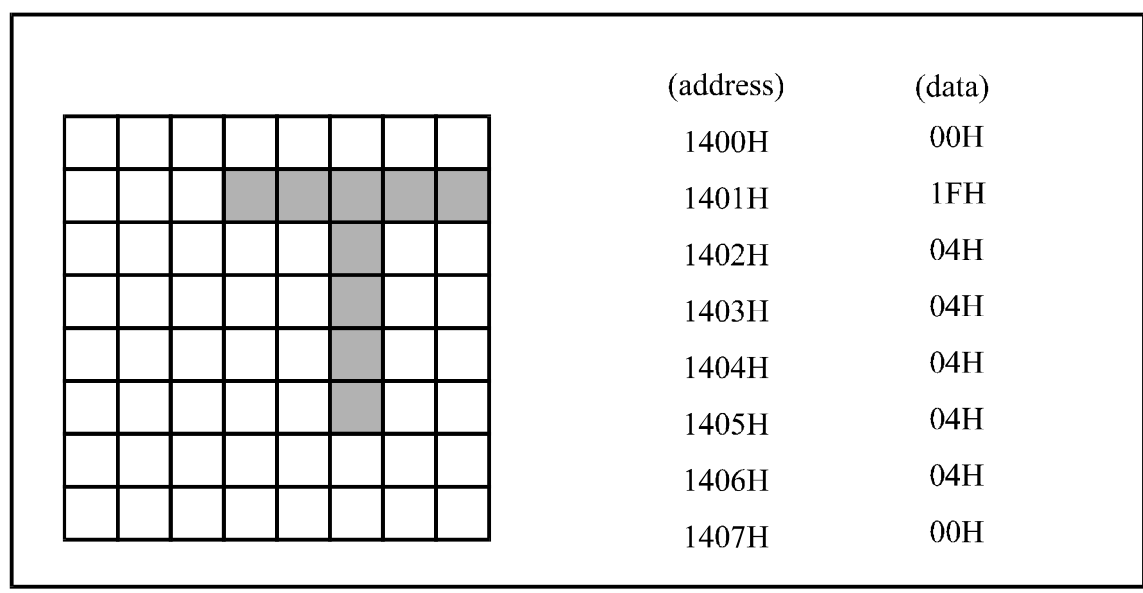

(Example 2) The relationship between display RAM data and display characters

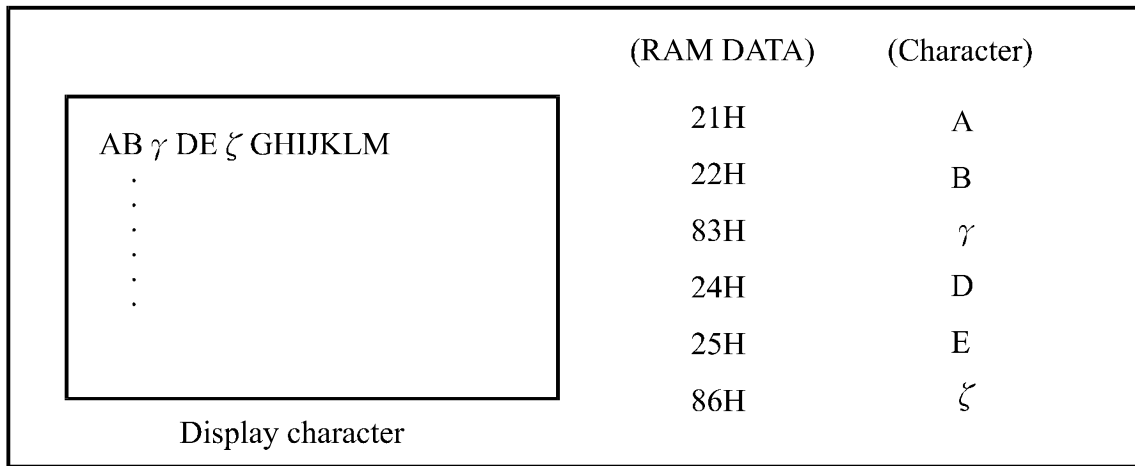

and are displayed by character generator RAM.

(3)Set Address Pointer

The Set Address Pointer command is used to indicate the start address for writing to (or reading from) external RAM.

The Flowchart for Set Address Pointer command

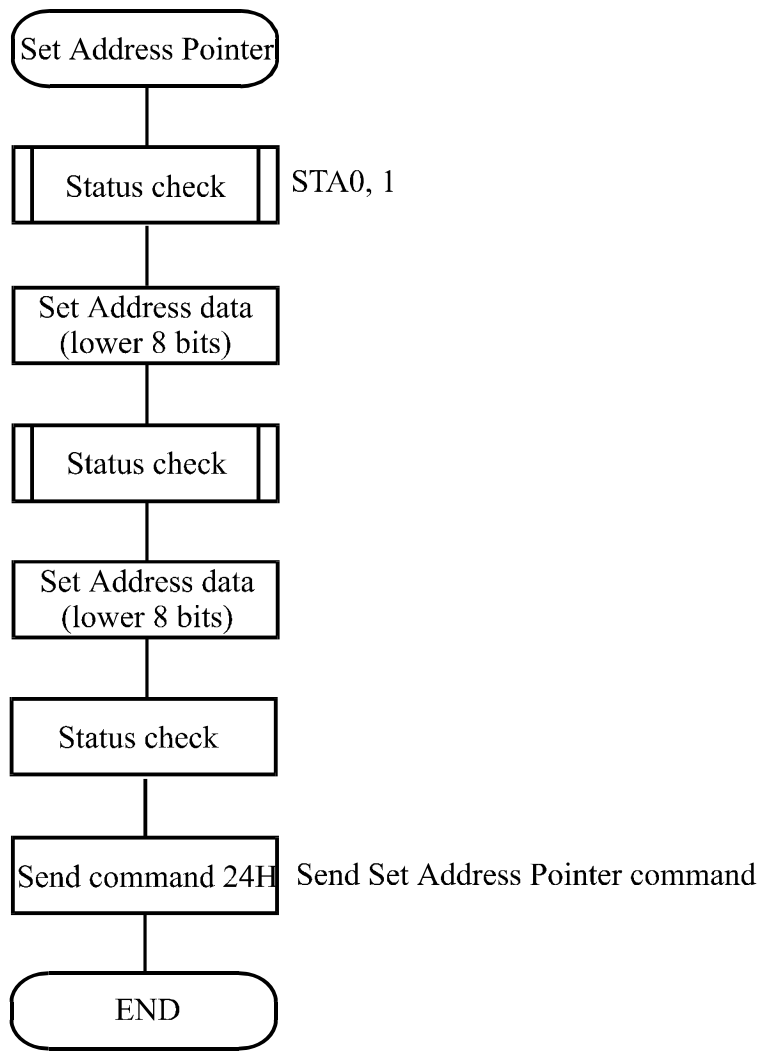

Set Control Word

CODE	HEX.	FUNCTION	D1	D2
01000000	40H	Set Text Home Address	Low address	High address
01000001	41H	Set Text Area	Columns	00H
01000010	42H	Set Graphic Home Address	Low address	High address
01000011	43H	Set Graphic Area	Columns	00H

The home address and column size are defined by this command.

(1)Set Text Home Address

The starting address in the external display RAM for text display is defined by this command.

The text home address indicates the leftmost and uppermost position.

The relationship between external display RAM address and display position

TH		TH+CL
TH+TA		TH+TA+CL
(TH+TA)+TA		TH+2TA+CL
(TH+2TA)+TA		TH+3TA+CL
TH+(n-1)TA		TH+(n-1)TA+CL

TH: Text home address

TA: Text area number (columns)

CL: Columns are fixed by hardware (pin-programmable).

(Example)

Text home address 0000H
 Text area 0020H
 32 Columns
 4 Lines

0000H	0001H		001EH	001FH
0020H	0021H		003EH	002FH
0040H	0041H		005EH	005FH
0060H	0061H		007EH	007FH

(2)Set Graphic Home Address

The starting address of the external display RAM used for graphic display is defined by this command. The graphic home address indicates the leftmost and uppermost position.

The relationship between external display RAM address and display position

GH		GH+GL
GH+GA		GH+GA+CL
(GH+GA)+GA		GH+2GA+CL
(GH+2GA)+GA		GH+3GA+CL
GH+(n-1)GA		GH+(n-1)GA+CL

GH: Graphic home address

GA: Graphic area number (columns)

CL: Columns are fixed by hardware (pin-programmable).

(Example)

Graphic home address	0000H
Graphic area	0020H
	32 Columns
	2 Lines

If the graphic area setting is set to match the desired number of columns on the LCD, the addressing scheme will be automatically modified so the start address of each line equals the end address of the previous line +1. Mode set

CODE	FUNCTION	OPERAND
1000×000	OR Mode	
1000×001	EXOR Mode	
1000×011	AND Mode	
1000×100	TEXT ATTRIBUTE Mode	
10000×××	Internal Character Generator Mode	
10001×××	External Character Generator Mode	

X: invalid

The display mode is defined by this command. The display mode does not change until the next command is sent. The logical OR, EXOR, AND of text or graphic display can be displayed. In Internal Character Generator mode, character codes 00H to 7FH are assigned to the built-in character generator ROM. The character codes 80H to FFH are automatically assigned to the external character generator RAM.

(Example)

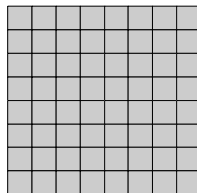

GRAPHIC

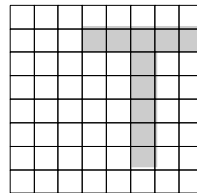

TEXT

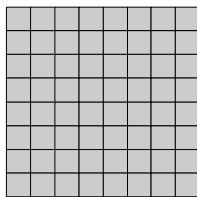

“OR”

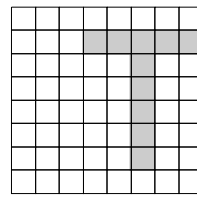

“AND”

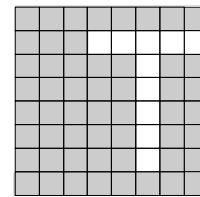

“TXOR”

(Note) Attribute functions can only be applied to text display, since the attribute data is placed in the graphic RAM area.

Attribute function

The attribute operations are Reverse display, Character blink and Inhibit. The attribute data is written into the graphic area which was defined by the Set Control Word command. Only text display is possible in Attribute Function mode; graphic display is automatically disabled. However, the Display Mode command must be used to

turn both Text and Graphic on in order for the Attribute function to be available.

The attribute data for each character in the text area is written to the same address in the graphic area. The Attribute function is defined as follows.

Attribute RAM 1byte



d3	d2	d1	d0	FUNCTION
0	0	0	0	Normal display
0	1	0	1	Reverse display
0	0	1	1	Inhibit display
1	0	0	0	Blink of normal display
1	1	0	1	Blink of reverse display
1	0	1	1	Blink of inhibit display

X: invalid

Display mode

CODE	FUNCTION	OPERAND
10010000	Display off	
1001xx10	Cursor on, blink off	
1001xx11	Cursor on, blink on	
100101xx	Text on, graphic off	
100110xx	Text off, graphic on	
100111xx	Text on, graphic on	

X: invalid

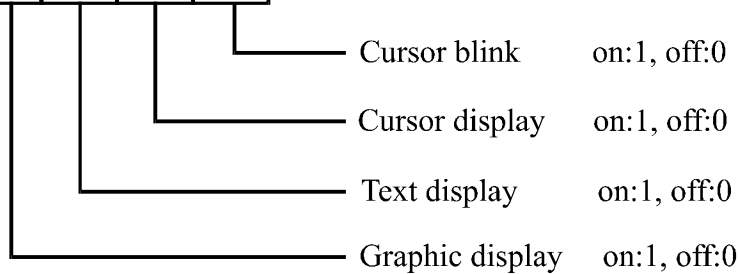
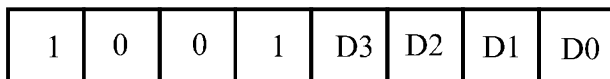

(Note) It is necessary to turn on “Text display” and “Graphic display” in the following cases.

- a) Combination of text/graphic display
- b) Attribute function

Cursor pattern select

CODE	FUNCTION	OPERAND
10100000	1-line cursor	
10100001	2-line cursor	
10100010	3-line cursor	
10100011	4-line cursor	
10100100	5-line cursor	
10100101	6-line cursor	
10100110	7-line cursor	
10100111	8-line cursor	

When cursor display is ON, this command selects the cursor pattern in the range 1 line to 8 lines.

The cursor address is defined by the Cursor Pointer Set command.

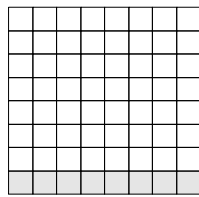

1-line cursor

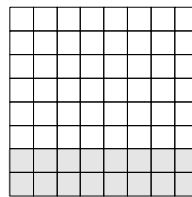

2-line cursor

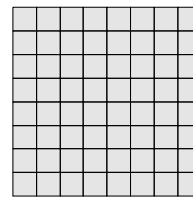

8-line cursor

Data Auto Read/Write

CODE	HEX.	FUNCTION	OPERAND
10110000	B0H	Set Data Auto Write	
10110001	B1H	Set Data Auto Read	
10110010	B2H	Auto Reset	

The command is convenient for sending a full screen of data from the external display RAM. After setting Auto mode, a Data Write (or Read) command need not be sent between each datum. A Data Auto Write (or Read) command must be sent after a Set Address Pointer command. After this command, the address pointer is automatically incremented by 1 after each datum. In Auto mode, the T6963C

cannot accept any other commands.

The Auto Reset command must be sent to the T69963C after all data has been sent, to clear Auto mode.

(Note)A Status check for Auto mode

(STA2, STA3 should be checked between sending of each datum. Auto Reset should be performed after checking STA3=1 (STA2=1.) Refer to the following flowchart.

a) Auto Read mode

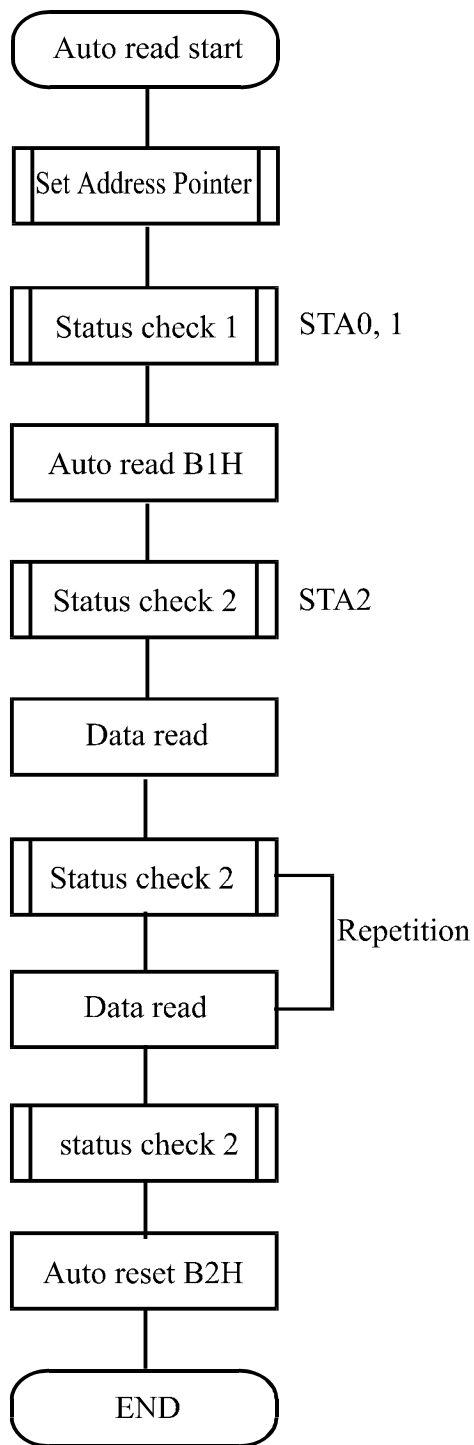

b) Auto Write mode

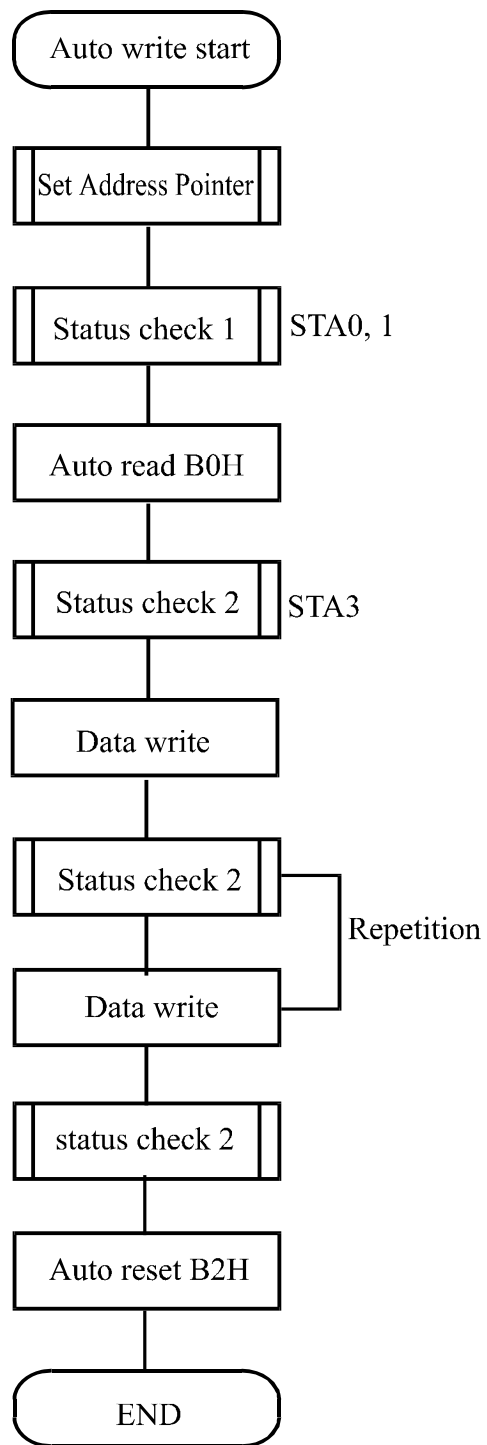

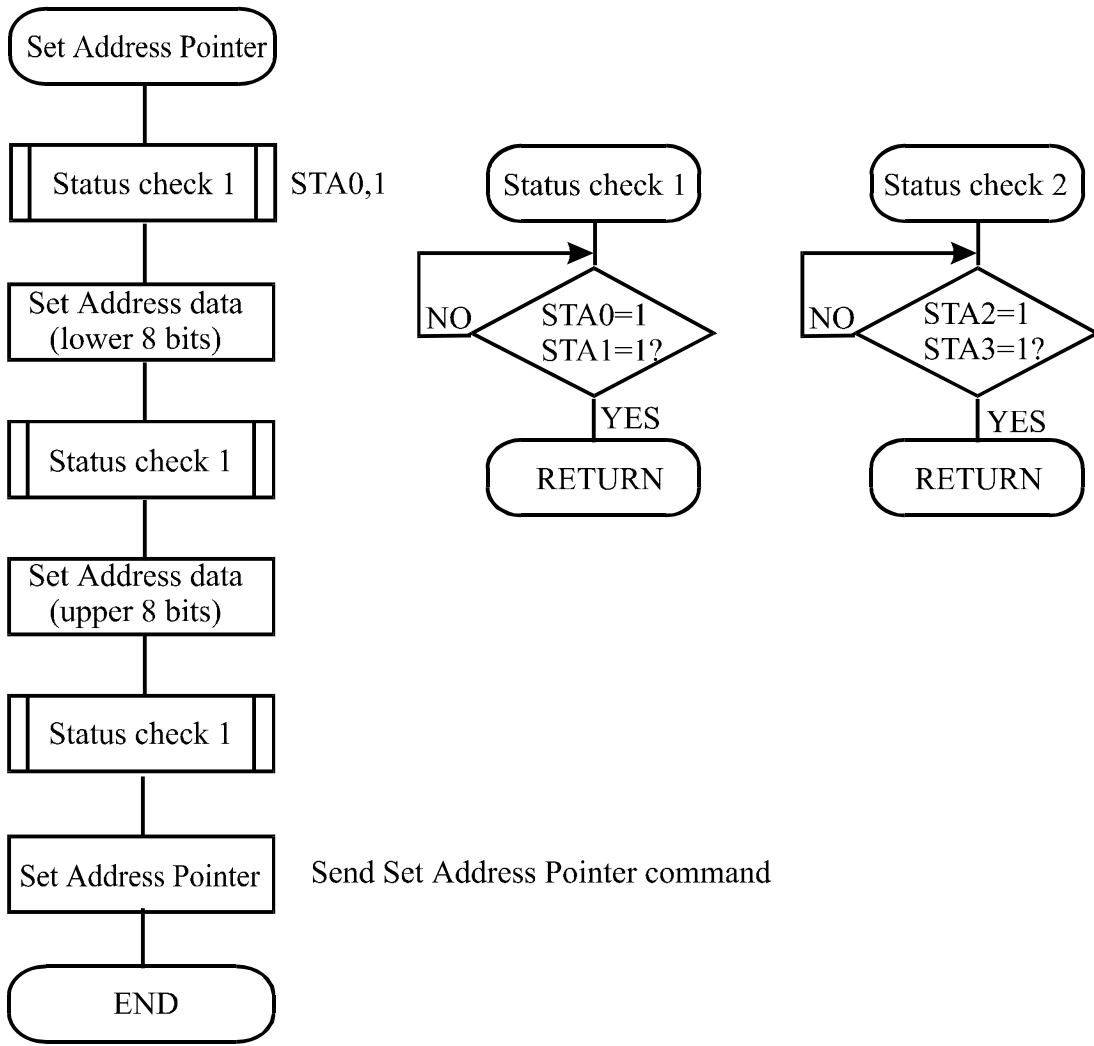

Date Read/Write

CODE	HEX.	FUNCTION	OPERAND
11000000	C0H	Data Write and Increment ADP	Data
11000001	C1H	Data Read and Increment ADP	
11000010	C2H	Data Write and Decrement ADP	Data
11000011	C3H	Data Read and Decrement ADP	
11000100	C4H	Data Write and Non-variable ADP	Data
11000101	C5H	Data Read and Non-variable ADP	

This command is used for writing data from the MPU to external display RAM, and reading data from external display RAM to the MPU. Data Write/Data Read should be executed after setting address using Set Address Pointer command. The address pointer can be automatically incremented or decremented using this command.

(Note) This command is necessary for each 1-byte datum.

Refer to the following flowchart.

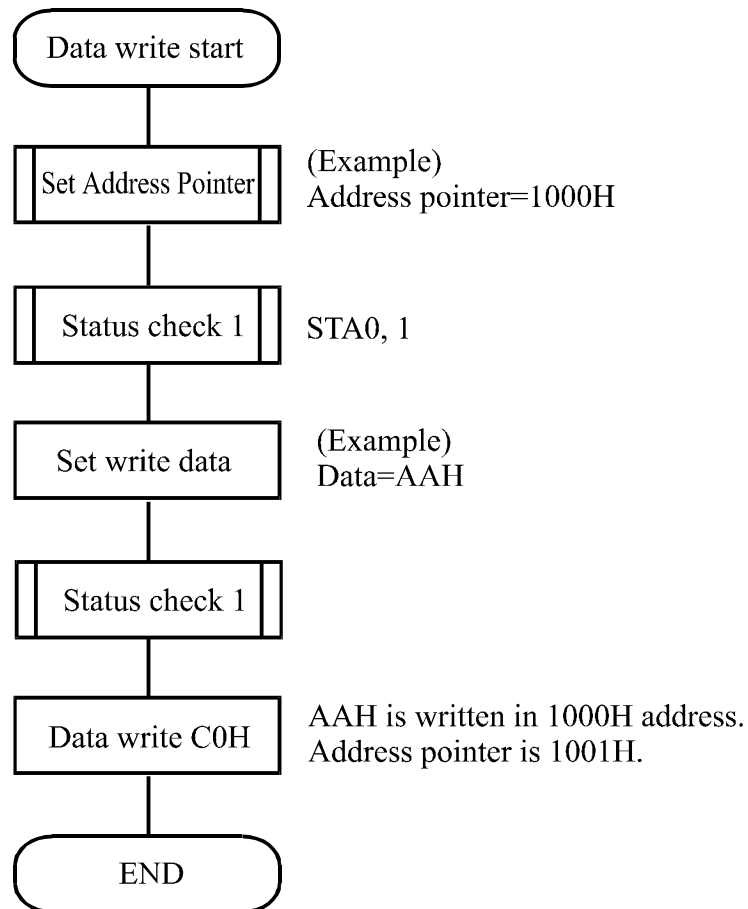

Screen Peek

CODE	HEX.	FUNCTION	OPERAND
11100000	E0H	Screen Peek	e

This command is used to transfer 1 byte of displayed data to the data stack; this byte can then be read from the MPU by data access. The logical combination of text and graphic display data on the LCD screen can be read by this command.

The status (STA6) should be checked just after the Screen Peek command. If the address determined by the Set Address Pointer command is not in the graphic area, this command is ignored and a status flag (STA6) is set.

Refer to the following flowchart.

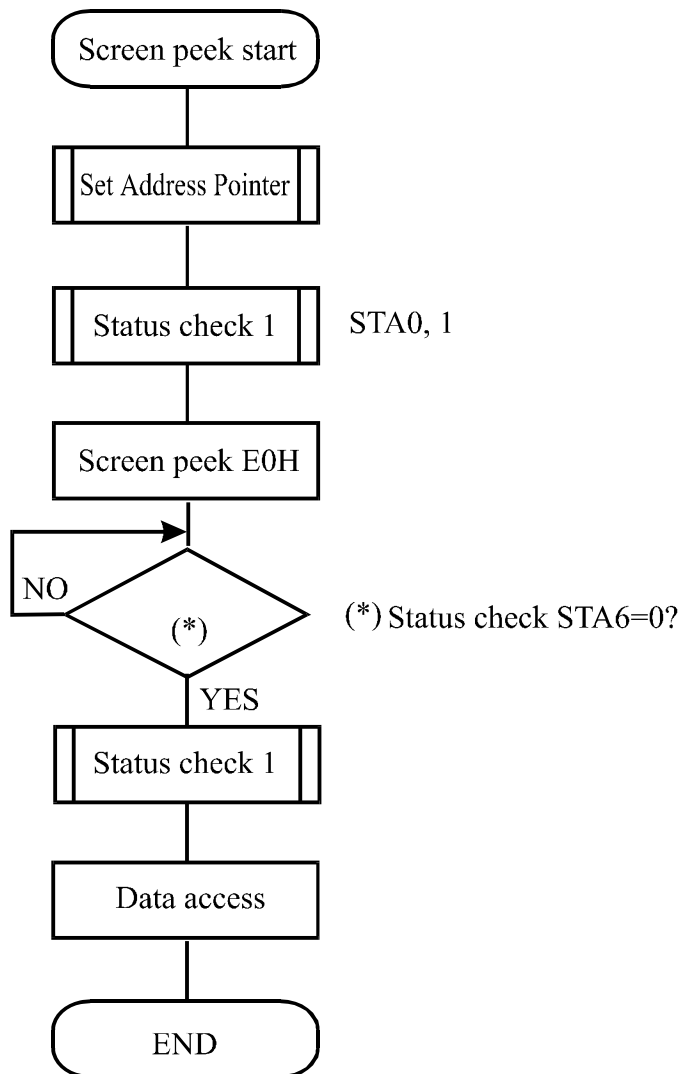

Screen Copy

CODE	HEX.	FUNCTION	OPERAND
11101000	E8H	Screen Copy	

This command copies a single raster line of data to the graphic area.

The start point must be set using the Set Address Pointer command.

(Note 1) If the attribute function is being used, this command is not available.

(With Attribute data is graphic area data.)

Refer to the following flowchart.

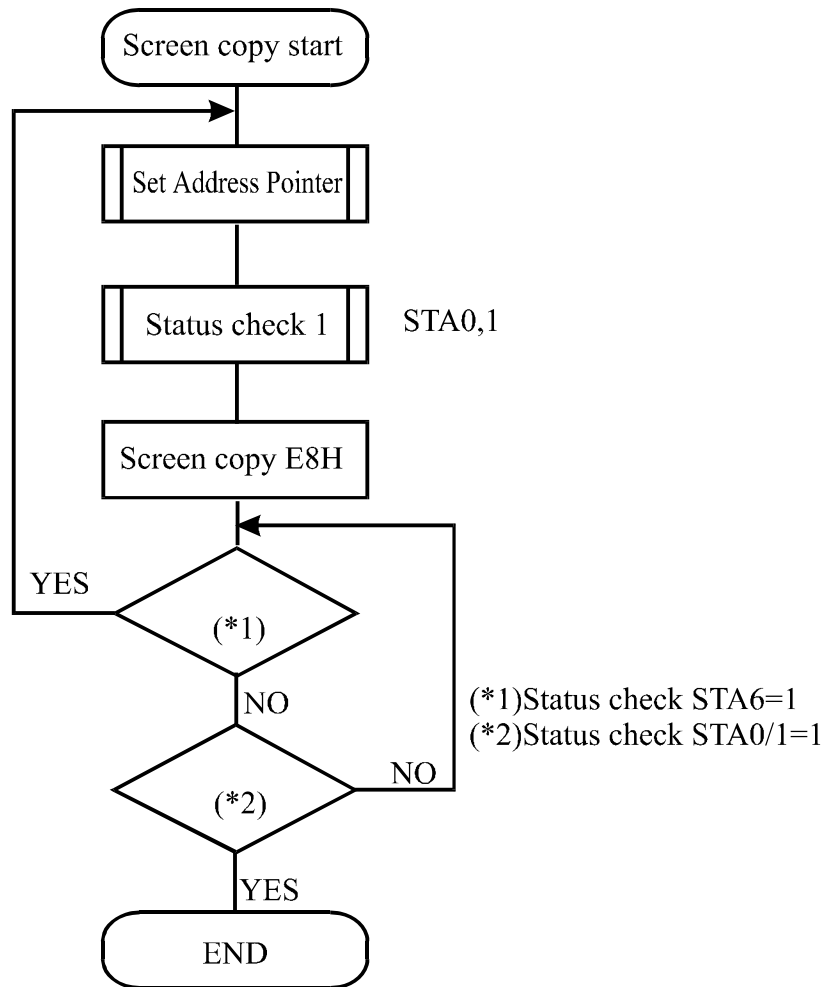

Bit Set/Reset

CODE	FUNCTION	OPERAND
------	----------	---------

1110×××	Bit Reset	
1111×××	Bit Set	
1111×000	Bit 0 (LSB)	
1111×001	Bit 1	
1111×010	Bit 2	
1111×011	Bit 3	
1111×100	Bit 4	
1111×101	Bit 5	
1111×110	Bit 6	
1111×111	Bit 7 (MSB)	

X: invalid

This command use to set or reset a bit of the byte specified by the address pointer.

Only one bit can be set/reset at a time.

Refer to the following flowchart.

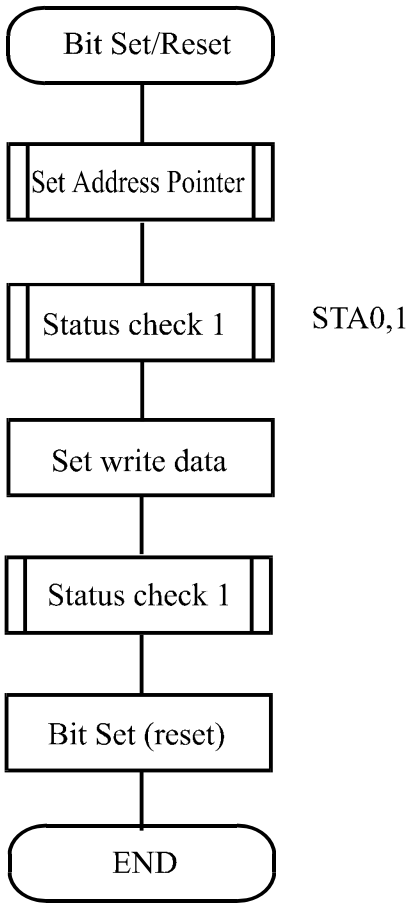

CHARACTER CODE MAP

Upper 4 bit Lower 4 bit	LLLL	LLLH	LLHL	LLHH	LHLL	LHLH	LHHL	LHHH
LLLL		0	1	2	3	4	5	6
LLLH	!	7	8	9	A	B	C	D
LLHL	"	E	F	G	H	I	J	K
LLHH	#	L	M	N	O	P	Q	R
LHLL	\$	S	T	U	V	W	X	Y
LHLH	%	Z	[\]	^	_	`
LHHL	~	0	1	2	3	4	5	6
LHHH	"	7	8	9	A	B	C	D
HLLL	E	F	G	H	I	J	K	L
HLLH	M	N	O	P	Q	R	S	T
HLHL	U	V	W	X	Y	Z	[\
HLHH]	^	_	`	~	0	1	2
HHLL	3	4	5	6	7	8	9	A
HHLH	B	C	D	E	F	G	H	I
HHHL	J	K	L	M	N	O	P	Q
HHHH	R	S	T	U	V	W	X	Y

11. Timing Characteristics

Bus Timing

($V_{SS} = 0\text{ V}$, $V_{DD} = 5\text{ V}$)

Item	Symbol	Min	Typ	Max	Unit
C/D Set-up Time	tCDS	100			ns
C/D Hold Time	tCDH	10			ns
CE,RD,WR Pulse Width	tCDS,tRD,tWR	80			ns
Data Set-up Time	tDS	80			ns
Data Hold Time	tDH	40			ns
Access Time	tACC			150	ns
Output Hold Time	tOH	10		50	ns

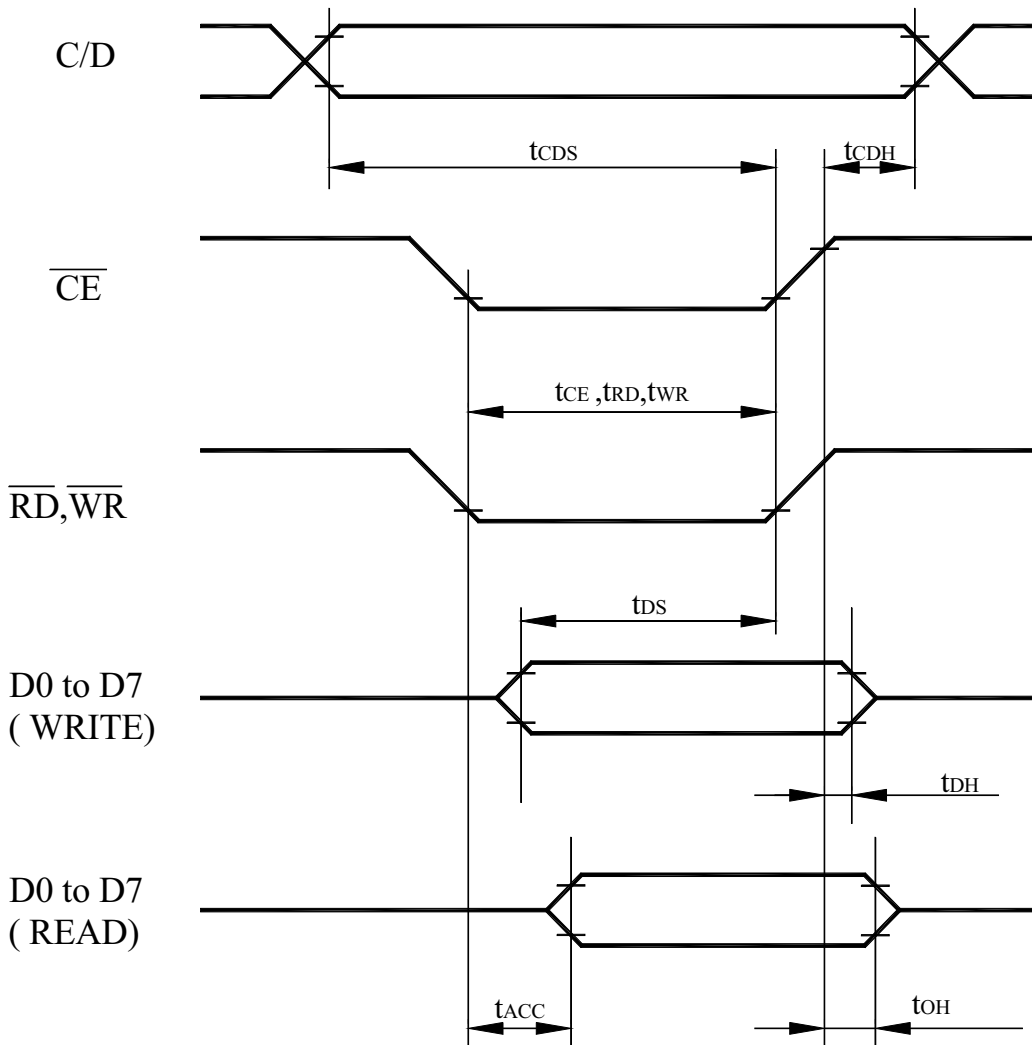

12. Quality Assurance

Screen Cosmetic Criteria

No.	Defect	Judgement Criteria	Partition																								
1	Spots	<p>A) Clear</p> <p><u>Size: d mm</u> <u>Acceptable Qty in active area</u></p> <table> <tr> <td>d</td> <td>0.1</td> <td>Disregard</td> </tr> <tr> <td>0.1<d</td> <td>0.2</td> <td>6</td> </tr> <tr> <td>0.2<d</td> <td>0.3</td> <td>2</td> </tr> <tr> <td>0.3<d</td> <td></td> <td>0</td> </tr> </table> <p>Note: Including pin holes and defective dots which must be within one pixel size.</p> <p>B) Unclear</p> <p><u>Size: d mm</u> <u>Acceptable Qty in active area</u></p> <table> <tr> <td>d</td> <td>0.2</td> <td>Disregard</td> </tr> <tr> <td>0.2<d</td> <td>0.5</td> <td>6</td> </tr> <tr> <td>0.5<d</td> <td>0.7</td> <td>2</td> </tr> <tr> <td>0.7<d</td> <td></td> <td>0</td> </tr> </table>	d	0.1	Disregard	0.1<d	0.2	6	0.2<d	0.3	2	0.3<d		0	d	0.2	Disregard	0.2<d	0.5	6	0.5<d	0.7	2	0.7<d		0	Minor
d	0.1	Disregard																									
0.1<d	0.2	6																									
0.2<d	0.3	2																									
0.3<d		0																									
d	0.2	Disregard																									
0.2<d	0.5	6																									
0.5<d	0.7	2																									
0.7<d		0																									
2	Bubbles in Polarizer	<p><u>Size: d mm</u> <u>Acceptable Qty in active area</u></p> <table> <tr> <td>d</td> <td>0.3</td> <td>Disregard</td> </tr> <tr> <td>0.3<d</td> <td>1.0</td> <td>3</td> </tr> <tr> <td>1.0<d</td> <td>1.5</td> <td>1</td> </tr> <tr> <td>1.5<d</td> <td></td> <td>0</td> </tr> </table>	d	0.3	Disregard	0.3<d	1.0	3	1.0<d	1.5	1	1.5<d		0	Minor												
d	0.3	Disregard																									
0.3<d	1.0	3																									
1.0<d	1.5	1																									
1.5<d		0																									
3	Scratch	In accordance with spots cosmetic criteria. When the light reflects on the panel surface, the scratches are not to be remarkable.	Minor																								
4	Allowable Density	Above defects should be separated more than 30mm each other.	Minor																								
5	Coloration	<p>Not to be noticeable coloration in the viewing area of the LCD panels.</p> <p>Back-light type should be judged with back-light on state only.</p>	Minor																								

13. RELIABILITY

Content of Reliability Test

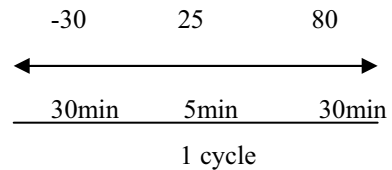
Environmental Test				
No.	Test Item	Content of Test	Test Condition	Applicable Standard
1	High Temperature storage	Endurance test applying the high storage temperature for a long time.	80 200hrs	—
2	Low Temperature storage	Endurance test applying the high storage temperature for a long time.	-30 200hrs	—
3	High Temperature Operation	Endurance test applying the electric stress (Voltage & Current) and the thermal stress to the element for a long time.	70 200hrs	—
4	Low Temperature Operation	Endurance test applying the electric stress under low temperature for a long time.	-20 200hrs	—
5	High Temperature/ Humidity Storage	Endurance test applying the high temperature and high humidity storage for a long time.	80 ,90%RH 96hrs	—
6	High Temperature/ Humidity Operation	Endurance test applying the electric stress (Voltage & Current) and temperature / humidity stress to the element for a long time.	70 ,90%RH 96hrs	—
7	Temperature Cycle	Endurance test applying the low and high temperature cycle. <div style="text-align: center;"> $-30 \quad 25 \quad 80$  </div>	-30 /80 10 cycles	—
Mechanical Test				
8	Vibration test	Endurance test applying the vibration during transportation and using.	10~55Hz 1.5mmp-p Total 0.5hrs	—
Others				
9	Static electricity test	Endurance test applying the electric stress to the terminal.	VS=800V,RS=1.5k CS=100pF 1 time	—

***Supply voltage for logic system=5V. Supply voltage for LCD system = Operating voltage at 25□

14. Backlight Information

14.1 Specification

PARAMETER	SYMBOL	MIN	TYP	MAX	UNIT	TEST CONDITION
Supply Current	I _{LED}	800	900	1350	mA	V=4.2V
Supply Voltage	V	4.0	4.2	4.4	V	
Reverse Voltage	V _R	□	□	8	V	
Luminous Intensity	I _V	160	200	□	CD/M ²	I _{LED} =900mA
Life Time		□	100K	□	Hr.	I _{LED} □900mA
Color	YELLOW/GREEN					

Note: The LED of B/L is drive by current only, drive voltage is for reference only. drive voltage can make driving current under safety area (current between minimum and maximum).