

Solutions for Outside Plant

3M Telecommunications offers an extensive range of housings and closures for outside plant. They are available in a variety of sizes, made from either plastic or metal. For housings, the preferred connection technologies are SID or QSA/LSA plus. For closures the proven splice methods Scotchlok or MS² are more appropriate. These give the maximum number of splices in the smallest possible space. With optical fibre cable, fibre management is more important than density. 3M Telecommunications extensive 'know-how' has produced a variety of closure sealing options. Both encapsulated and mechanically-closed closures are available. For example, the BPEO family of closures are re-enterable several times and do not require specialist tools or additional materials such as gaskets or mastic.



2. Solutions for Outside Plant	104 - 227
2.1 Copper Splicing	106 - 122
Scotchlok Connectors and Tools	106 - 111
MS ² 25-Pair Splice Modules and Accessories	112 - 116
MS ² 10-Pair Splice Modules and Accessories	117 - 118
MS ² 25-Pair Modular Splicing Rigs & Equipment	119 - 122
2.2 Splice Protection Products	123 - 187
Closures SLiC	123 - 128
3M Floating Bond, 3M Rigid Bond, 3M Spiral End Seal	123 - 125
SLiC Aerial Terminal and SLiC Aerial Terminal with Spiral End Seal	126 - 128
Shield Bonding Products	129 - 130
SLiC Aerial Terminal 319	131 - 132
Dome Closure	133 - 134
OS Closures	135 - 136
Distribution Closure BDR	137 - 138
Pressurised Closures	139 - 144
50/51P Series	139 - 140
Closure System 2-Type 505	141 - 144
Encapsulated Closures	145 - 146
Better Buried Closures	147 - 154
K&B Closures	155 - 163
Vault Closures	155 - 158
Vault and Riser Closures	159 - 161
Building Riser Closure	162 - 163
Scotchcast Closures 8980 Series	164 - 167
Lubricants	168 - 176
Multi-Purpose Gel Cable Lubricant	168 - 170
Multi-Purpose Liquid Cable Lubricant	171 - 173
Concentrated Multi-Purpose Cable Lubricant	174 - 176
Scotchcast Components	177 - 178
High Gel Re-enterable Encapsulant 8882	179 - 181
Identification Products and Reflective Tapes	182 - 183
Miscellaneous Accessories	184 - 185
Sheath Repair Products	186 - 187
2.3 Cross Connection Product Range	188 - 193
Quick Connect System 2810	188 - 190
Connection modules SID-C	191 - 192
Connection modules SID-C EXTREME	193 - 193
2.4 Distribution Point Product Range	194 - 207
High reliability drop wire connectors MX 2000	194 - 195
Drop wire distribution points	196 - 202
Overview	196 - 197
BMX	198 - 199
BDX	200 - 202
Protection and mechanical resistance for enclosures	203 - 207
DDB	204 - 205
CDS	206 - 207
2.5 Copper Test Equipment	208 - 227
Advanced Modular System 965AMS	208 - 215
Advanced Modular System 965AMS/SA30	216 - 217
All-in-one Modem Module VDSL2	218 - 218
Far End Devices II + III	219 - 222
Qualification Test Set 950ADSL2 Plus	223 - 227

2.1 Copper Splicing

Description - 3M™ Scotchlok™ Connectors and Tools

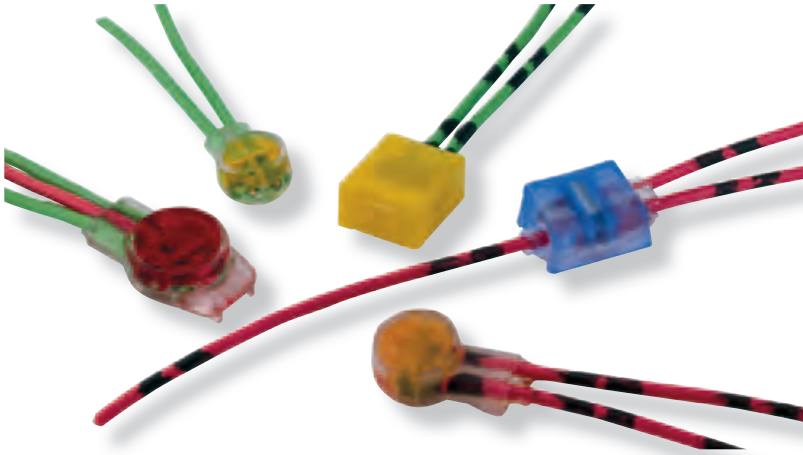

Over 40 years ago, 3M™ introduced the industry's original U element connector, the Scotchlok UR Connector. The latest series of connectors, the Scotchlok UR2, UY2, and UB2A Connectors, feature that same originality in technology advantages, building on the successful Scotchlok Connector's design, shape, color-coded cap concepts, and element technology.

The Series 2 Connectors additionally offer full wire range capability, increased port size to accommodate up to 2.08 mm (0.082») insulation sizes, double elements in all products, and a solvent resistant plastic construction.

UR2/UR2-D Butt Connectors

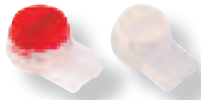

The UR2 Connector accepts two or three solid copper conductors that can be of different wire

gauges for butt splicing. The connector is filled with a moisture resistant sealant and the UR2-D Connector is a dry version. **RUS Listed**

UY2/UY2-D Butt Connectors



The size of the UY2 Connector reduces the splicing bundle O.D. to a minimum. The wires joined can

be of different wire gauges. Factory inserted sealant seals out moisture. In addition, the UY2 Connector is available in a dry version, UY2- D Connector. **RUS Listed**

UB2A/UB2A-D Tap Connectors

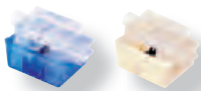

The UB2A Connector has a pre-crimp feature that gives the user a time-saving edge. By positioning

the connector on the conductor and precrimping, the conductor is prevented from slipping out of the connector before the crimp is completed.

Like the UR2 Connector, a factory sealant insulates against moisture and seals out corrosion. The UB2A Connector permits tapping directly onto an existing conductor without interrupting service. In ready access closures, the UB2A Connector eliminates cutting cable pairs, opening circuits, and piecing out wires. The UB2A-D Connector is a dry version of the UB2A Connector. **RUS Listed**

211 Trim-Out Connector



The Scotchlok™ 211 Trim-Out Connector is a polypropylene, moisture-resistant, self-stripping insulation

displacement contact device with a built-in cut-off blade and a test port. Wires are positioned in the connector from the sides, allowing the 211 Connector to be used as a maintenance connector for replacing problem connectors without interrupting service. The 211 Connector may also be used for standard two-wire butt type splicing operations.

A pre-crimp feature permits easy, positive connector positioning by gripping the conductors until the crimp is completed. Excess wire is cut off when the connector is crimped. **RUS Listed**

557TG Connector



Use the Scotchlok 557TG aerial connector to electrically connect two dropwire solid copper legs, insulate

and provide moisture protection for the connection.

2.1 Copper Splicing

Description - 3M™ Scotchlok™ Connectors and Tools

UP2 Butt Connector

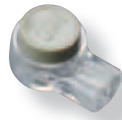

resistance is not a requirement.

A dry flame retardant two-wire, UL Listed connector for use on paper, pulp or PIC cable where moisture

UP3 Butt Connector



resistance is not a requirement.

The UP3 Butt connector is a dry, flame-retardant two or three-wire connector for paper, pulp or PIC cable where moisture

UPB Tap Connector



or PIC cable where moisture resistance is not a requirement.

A dry, flame-retardant, two-wire UL Listed connector with a pre-crimp feature for use on pulp, paper

U1B Inline Connectors



gauge solid copper.

The U1B connector is a sealed moisture-resistant four-wire (1 full pair) inline connector for larger

U1R Inline Connectors



larger gauge solid copper.

The U1R connector is a sealed moisture-resistant four-wire (1 full pair) inline connector for

UDW2 Inline connector



conductors. Not for mid-span splices unless strain-relief is provided. Tape over-wrap is not required.

A sealed moisture-resistant, four-wire (1 full pair) inline aerial connector for copper or copper-coated steel

E-9Y Crimping Tool



handles, and a return spring. Not recommended for any 19 gauge, 3 wire application due to fatigue factor.

Stepped jaws and long nose provide parallel crimping action. Features include a side wire cutter, insulated

E-9J Crimping Tool



a work-saving 10-to-1 mechanical advantage over applied hand force. For use with Scotchlok butt and tap connectors.

The E-9J tool is a lightweight, handheld tool featuring a singlestroke, parallel crimping action with

E-9BM Crimping Tool



For use with all Scotchlok Connectors.

The E-9BM has parallel closing action with adjustable jaws, and features high mechanical advantage.

E-9C Cartridge Tool with Case & Gauge

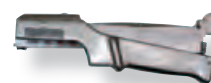

other hand for guiding wires. This time-saving tool holds cartridges of UR2, UR2-D, UR, UY2, UY2-D, UY, UAL, ULG, UCC, UPC, UP2 and UP3 Connectors. Its automatic feed, ratchet, and parallel jaw action assure perfect crimps every time.











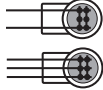

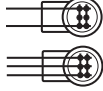

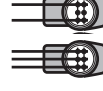
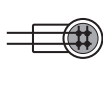
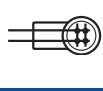
The E-9C tool holds the connectors (in cartridges) firmly in place, allowing the user the use of the

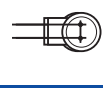
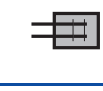
2. Solutions for Outside Plant

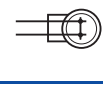
2.1 Copper Splicing

Description - 3M™ Scotchlok™ Connectors and Tools

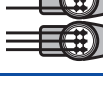
Specification Chart

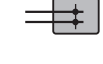











			Maximum Insulation O.D.		PIC-unfilled and PIC-filled		Pulp or Paper	
Connector	Type Connector	Special Features	Metric (mm)	Inches	AWG	Metric (mm)	AWG	Metric (mm)
UR2 		Gel-filled RUS and UL Listed Polypropylene	2,08	0,082	19-26	0,9-0,4	N/A	N/A
UR2-D 		Dry Polypropylene	2,08	0,082	19-26	0,9-0,4	19-26	0,9-0,4
UR 		Gel-filled RUS and UL Listed Polycarbonate	1,52	0,060	19-26	0,9-0,4	N/A	N/A
UY2 		Gel-filled RUS and UL Listed Polypropylene	2,08	0,082	19-26	0,9-0,4	N/A	N/A
UY2-D 		Dry Polypropylene	2,08	0,082	19-26	0,9-0,4	19-26	0,9-0,4
UY 		Gel-filled UL Listed Polycarbonate	1,52	0,060	22-26	0,7-0,4	N/A	N/A
*557TG 		Gel-filled Flame Retardant Polypropylene	3,0	0,12	16-22	1,3-0,6	N/A	N/A
UYF 		Gel-filled UL Listed Polycarbonate	1,52	0,060	20-26	0,8-0,4	N/A	N/A
UP2 		Dry Flame Retardant RUS and UL Listed Polycarbonate	1,52	0,060	22-26	0,7-0,4	22-26	0,7-0,4
UP3 		Dry Flame Retardant RUS and UL Listed Polycarbonate	1,52	0,060	19-26	0,9-0,4	19-26	0,9-0,4
UAL 		Gel-filled For Aluminium Polycarbonate	2,08	0,082	17-20 AL 19-24 CU	1,2-0,8 AL 0,9-0,5 CU	N/A	N/A
211 		Gel-filled RUS and UL Listed Polypropylene	2,08	0,082	19-26	0,9-0,4	N/A	N/A

Butt Splicing

2.1 Copper Splicing

Description - 3M™ Scotchlok™ Connectors and Tools

Specification Chart

			Maximum Insulation O.D.		PIC-unfilled and PIC-filled		Pulp or Paper		
	Connector	Type Connector	Special Features	Metric (mm)	Inches	AWG	Metric (mm)	AWG	Metric (mm)
	Tap Splicing	UB2A 		Gel-filled RUS and UL Listed Polypropylene	2,08	0,082	19-26	0,9-0,4	N/A
UB2A-D 			Gel-filled RUS Listed Polypropylene	2,08	0,082	19-26	0,9-0,4	N/A	N/A
UG 			Gel-filled RUS Listed Polycarbonate	Butt 1,54 Tap 1,12	0,051 0,044	19-26 22-26	0,9-0,4 0,7-0,4	N/A	N/A
UPB 			Dry UL Listed Flame Retardant Polycarbonate	1,27	0,050	22-26	0,7-0,4	22-26	22-26
Inline Splicing	*UDW2 		Full Pair Drop Pair Polycarbonate	4,4	0,175	16-19	1,3-0,9	N/A	N/A
	*U1B 		Gel-filled Full Pair Polycarbonate	3,18	0,125	16-19	1,3-0,9	N/A	N/A
	*U1R 		Gel-filled Full Pair Polypropylene	3,18	0,125	19-24	0,9-0,5	N/A	N/A

To reduce fatigue, use tool within each group with highest mechanical advantage indicated in ().



E-9BM
(10:1)



E-9C
(7:1)



E-9Y*
(3:1)



E-9R
(10:1)















E-9J
(10:1)

*Inline and drop wire connectors can only be used with E-9BM.
The use of the E-9Y is not recommended for 0,9mm (19AWG) conductor and larger.

2. Solutions for Outside Plant







2.1 Copper Splicing

Ordering Information

Connector	Box Packaging Weight kg (lbs.) Minimum Order	Bulk Packaging Weight kg (lbs.) Minimum Order	Cartridge Packaging Weight kg (lbs.) Minimum Order	Ref. No.
 UR2	100/box, 1000/cs. 1,36 (3) Min. Order: 1000 connectors	v500/box, 5000/cs. 6,7 (15,2) Min. Order: 5000 connectors	10/cart, 100/pak., 1000/cs. 2,09 (4,6) Min. Order: 1000 connectors	UR2
 UR2-D	N/A N/A N/A	v500/box, 5000/cs. 6,7 (15,2) Min. Order: 5000 connectors	10/cart, 100/pak., 1000/cs. 2,09 (4,6) Min. Order: 1000 connectors	UR2-D
 UR	100/box, 1000/cs. 1,36 (3) Min. Order: 1000 connectors	v500/box, 5000/cs. 6,7 (15,2) Min. Order: 5000 connectors	10/cart, 100/pak., 1000/cs. 2,09 (4,6) Min. Order: 1000 connectors	UR
 UY2	100/box, 1000/cs. 0,9 (1,3) Min. Order: 1000 connectors	v1000/box, 5000/cs. 2,8 (6,1) Min. Order: 5000 connectors	12/cart, 100/pak., 1000/cs. 1,4 (3,5) Min. Order: 1200 connectors	UY2
 UY2-D	N/A N/A N/A	1000/box, 5000/cs. 2,8 (6,1) Min. Order: 5000 connectors	2/cart, 100/pak., 1000/cs. 1,4 (3,5) Min. Order: 1200 connectors	UY2-D
 UY	100/box, 1000/cs. 0,9 (1,3) Min. Order: 1000 connectors	1000/box, 5000/cs. 2,8 (6,1) Min. Order: 5000 connectors	16/cart, 160/pak., 1600/cs. 1,4 (3,5) Min. Order: 1600 connectors	UY
 557TG	N/A N/A N/A	v500/box, 5000/cs. 9,09 (20) Min. Order: 5000 connectors	N/A N/A N/A	557TG
 UYF	500/box, 2500/cs. 2,15 (4,75) Min. Order: 2500 connectors	N/A N/A N/A	N/A N/A N/A	UYF
 UP2	N/A N/A N/A	1000/box, 5000/cs. 2,4 (5,4) Min. Order: 5000 connectors	16/cart, 160/pak., 1600/cs. 1,4 (3,2) Min. Order: 1600 connectors	UP2
 UP3	N/A N/A N/A	v1000/box, 5000/cs. 7,1 (13,3) Min. Order: 5000 connectors	10/cart, 100/pak., 1000/cs. 2,0 (4,4) Min. Order: 1000 connectors	UP3
 UAL	N/A N/A N/A	N/A N/A N/A	10/cart, 100/pak., 1000/cs. 2,1 (4,7) Min. Order: 1000 connectors	UAL
 211	100/box, 1000/cs. 1,2 (2,6) Min. Order: 1000 connectors	N/A N/A N/A	N/A N/A N/A	211

2.1 Copper Splicing

Ordering Information

Connector	Box Packaging Weight kg (lbs.) Minimum Order	Bulk Packaging Weight kg (lbs.) Minimum Order	Cartridge Packaging Weight kg (lbs.) Minimum Order	Ref. No.
 UB2A	100/box, 1000/cs. 1,2 (2,6) Min. Order: 1000 connectors	v500/box, 5000/cs. 5,9 (12,9) Min. Order: 5000 connectors	N/A N/A N/A	UB2A
 UB2A-D	100/box, 1000/cs. 1,2 (2,6) Min. Order: 1000 connectors	v500/box, 5000/cs. 5,9 (12,9) Min. Order: 5000 connectors	N/A N/A N/A	UB2A-D
 UG	100/box, 1000/cs. 1,1 (2,5) Min. Order: 1000 connectors	v1000/box, 5000/cs. 5,2 (11,6) Min. Order: 5000 connectors	N/A N/A N/A	UG
 UPB	N/A N/A N/A	v1000/box, 5000/cs. 3,0 (6,6) Min. Order: 5000 connectors	N/A N/A N/A	UPB
 UDW2	25/bag, 100/box N/A Min. Order: 1000 connectors	N/A N/A N/A	N/A N/A N/A	UDW2
 U1B	100/box, 1000/cs. 7,3 (16,0) Min. Order: 5000 connectors	N/A N/A N/A	N/A N/A N/A	U1B
 U1R	100/box, 1000/cs. 7,4 (16,2) Min. Order: 2500 connectors	N/A N/A N/A	N/A N/A N/A	U1R

TOOLS	E-9BM CRIMPING TOOL	E-9C CARTRIDGE TOOL	E-9R CRIMPING TOOL	E-9Y CRIMPING TOOL*	E-9J CRIMPING TOOL
Packaging kg (lbs.)/cs.	4,3 (9,5)	1/cs., 0,91 (2)	1/bag, 10/cs., 2,59 (5,7)	1/bag, 10/cs., 1,53 (3,3)	1/bag, 10/cs., 4,1 (9,02)
Minimum Order	10 each	1 each	10 each	10 each	10 each

* Not recommended for 19 AWG and larger.
For more information, please contact your local 3M representative.

2.1 Copper Splicing

Description - 3M™ MS²™ 25 -Pair Splice Modules and Accessories

MS² 25-Pair Super-Mini Splicing Modules

The MS² Super-Mini 25-pair and MS² Super Mate 25-pair Splicing Modules provide the reliability of soldered connections, the efficiency of multi-pair splicing, plus the proven performance of MS² splicing system.

The MS² 4000TR Series Super-Mini and 4005TR Series Super Mate Modules are the basic components of MS² Modular System Splicing from 3M™. The modules are building blocks of a systematized splicing technology that can reduce installation time of outside or inside plant, and in addition can reduce reworking demands, saving both time and effort in your construction and maintenance programs. To make your job easier, all MS² modules are now transparent.



U-shaped contacts enable solder-equivalent connections

The MS² 4000TR 25-pair Series Super-Mini and MS² 4005TR Super Mate Modules feature an array of U-shaped, phosphor-bronze contacts and stainless steel cut-off blades.

As a module is crimped, each contact strips the insulation from the positioned wire and securely grips the conductor. During this crimping operation, the cut-off blades inside each module trim the excess wire.

A single crimp completes a gas-tight connection on all 25-pairs in the module. It's simple and fast, because there's no need to strip or trim any of the individual pairs.

Pair testing is easy

Test entry ports on the front side of all modules provide access for testing individual pairs. All tests can be accomplished without opening the module, stripping insulation, or otherwise interrupting service.

The rugged design and construction of the modules can withstand crimping and reopening to facilitate transfers or cable rearrangements.

MS² 4000-G/TR Super-Mini Splicing Module

The new 4000-G/TR Super-Mini Splicing Module not only meets CAT-5 requirements of the TIA/EIA 568A and the ISO/IEC 11801:1995 for high-speed connectors, but it also delivers in place performance withstanding extended exposure to various conditions of extremely high humidity, including water immersion, while maintaining insulation resistance and circuit integrity.

MS² 4000-DWP/TR Module with Sealant Box

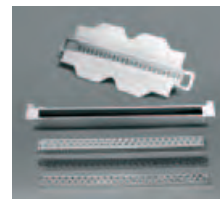

The 4000-DWP/TR 25-pair module combines a 4000- D/TR Super-Mini Module with a 4075-S Sealant Box. This combination offers waterproof

splicing of copper in buried, aerial, and under ground applications.

The module also makes reentry into splices encapsulated with re-enterable gel much easier. Because the sealant box prevents the encapsulants from filling the wire channels and test entry ports, modules may be tested at any time once the sealant box is removed.

The term "waterproof" applies to this system as determined according to 3M™ Test Method No. TP0200-05. Users should write for this method to determine suitability for application.

The MS² 4008D/TR 25-pair Series Super-Mini Modules are similar to the 4000TR Series, except that the cut-off blades have been removed from the bottom of the modules. This allows the run of through wires to be half-tapped without cutting the conductors. The wires in the base are electrically connected, but are not cut off. Both 4000TR and 4008TR Series Modules are available dry, or encapsulated. **RUS Listed**

2.1 Copper Splicing

Description - 3M™ MS²™ 25 -Pair Splice Modules and Accessories

MS² 4075-S Sealant Box



The 4075-S Sealant Box is a molded PBT polyester box designed to be used with the MS² 4000 Series Super-Mini Modules.

One applicator tool is included with every order. **RUS Listed**



MS² 4005-DPM/TR Super Mate Pluggable Module

4005-DPM/TR 25-pair Series Super Mate Pluggable Modules increase productivity and reduce expense by avoiding the time and cost-intensive job of cutting and re-splicing conductors for re-arrangement, addition, and removal of apparatus and stubs. The 4005-DPM/TR Series Super Mate Modules plug into other Super Mate Modules and onto the top of the 4000-D/TR Super-Mini Module Series for bridging applications. The 4005-CBM/TR Series Modules is for bridging to encapsulated 4000-C Series Modules, as a bridge only. The UL Listed 4005-DPM/FR is for applications which require a flame-retardant module.

MS² 4077 Series Sealant Boxes



Designed for use with MS² 4005-DPM/TR Super Mate Modules and/or in combination with 4000-D/TR Modules. The Sealant Boxes provide waterproof protection in PIC splicing applications where one or more modules are plugged together.

One applicator tool is included with each box of 12 sealant boxes.

The term "waterproof" applies to this system as determined according to 3M™ Test Method No. TP0200-05. Users should write for this method to determine suitability for application. **RUS Listed**

4077-A One	4005-DPM/TR Module
4077-B One	4000-D/TR and one 4005-DPM Module
4077-C Two	4005-DPM/TR Modules
4077-D Three	4005-DPM/TR Modules

For closures, please, see chapter 2.2

Ordering Information

Sealant Boxes

Packaging & kg (lbs.)/cs.	Minimum Order	Ref. No.
> 12/box, 120/cs & 7,5 (16.6)	120 each	4000DWP/TR
> 12/box, 120/cs & 4,1 (9.1)	120 each	4075-S
> 12/box, 120/cs. & 4,9 (10.8)	120 each	4077-A
> 12/box, 120/cs. & 5,4 (12)	120 each	4077-B
> 12/box, 120/cs. & 6,0 (13.3)	120 each	4077-C
> 12/box, 120/cs. & 7,5 (16.6)	120 each	4077-D



2.1 Copper Splicing

Technical characteristics

Specifications for all MS² 4000/4005/4008 Series Splicing Modules (Super-Mini and Super Mate)

Maximum Insulation O.D.	
Metric (mm)	1,65 [4000G/TR has maximum insulation O.D. of 1,35 mm (0.053")]
Inches	0.065
Cable Type PIC, Pulp or Paper	
AWG	22-28
Metric (mm)	0,7-0,3



3M MS² 4000 Series Straight Splicing Modules

Splicing Module	4000-D/TR	4000-G/TR	4000-DCO	4000-DT/TR	4000-GT/TR
Modular Type					
	RUS Listed Dry transparent	Gelled transparent	Dry/flame-retardant	Dry/test transparent	Gelled transparent
Colour					
Cover	Transparent	Transparent	Grey	Transparent	Transparent
Body top	Yellow	Yellow	Grey	Yellow	Yellow
Body bottom	Dark gold	Dark gold	Grey	Dark gold	Dark gold
Base	Transparent smoked	Transparent smoked	Grey	Transparent smoked	Transparent smoked
Sealant Boxes for 4000 Modules 	4075-S	N/A	N/A	4075-S	N/A



2.1 Copper Splicing

Technical characteristics

MS² 4005 Series Pluggable/Bridge Splicing Modules

Splicing Module	4005-GBM/TR	4005-DPM/FR
Module Type		
	Filled bridge transparent	Dry/flame-retardant
Colour		
Cover	Transparent	Grey
Body top	Yellow	Grey
Body bottom	Blue	Dark blue
Insulator	Red	Maroon

MS² 4008 Series Half-Tap-Splicing Modules

Splicing Module	4000-D/TR	4000-G/TR	4000-DCO
Module Type	RUS Listed		
	Dry transparent	Gelled transparent	Dry/flame-retardant
Colour			
Cover	Transparent	Transparent	Grey
Body top	Yellow	Yellow	Grey
Body bottom	Dark gold	Dark gold	Grey
Base	Transparent smoked	Transparent smoked	Grey
Sealant Boxes for 4008 Modules 	4075-S after cut out	N/A	N/A

2.1 Copper Splicing

Ordering Information

MS² Components and Accessories

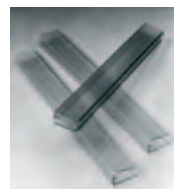

	Pkg & kg (lbs.)/cs.	Min. Order	Ref. No.
<p>> Super-Mini Module Cover The 4003-D/TR Super-Mini Module Cover is identical to the 4003-D Cover with the exception that it is clear to allow for the visual inspection of conductors.</p>	12/bag 120/cs. 0,6 (1.4)	120 each	4003-D/TR
<p>> Super-Mini Module Base The 4004-D/TR Super-Mini Module Base is identical to the 4004-D Super-Mini Module Base with the exception that it is smoked transparent.</p>	12/bag 1 120/cs. 0,6 (1.4)	20 each	4004-D/TR
<p>> Super-Mini Test Base The 4004-DT/TR Super-Mini Test Base is identical to the 4004-DT Super-Mini Test Base with the exception that it is smoked transparent.</p>	12/bag 120/cs. 0,6 (1.3)	120 each	4004-DT/TR
<p>> 4005-DPM/TR/36PTJ Preterminated Jumper Assemblies The assemblies consist of 24 AWG, PIC, unsheathed 25-pair binder group terminated on each end with a 4005-DPM Module. It enables quick restoration of cut cable and is available in 91,4 cm (36") and 182,9 cm (72") lengths with transparent covers.</p>	12 assy./kit 12/cs. 36" 2,63 (5.8) 72" 3,8 (8.5)	12 each 12 each	4005-DPM/TR/36PTJ
<p>> Bottom Test Plug The 4005-DPM/BTP is a test plug assembly consisting of a 4005-DPM module attached by a 60,9 cm (24") jumper to a module designed to plug into the bottom of a Super-Mini module. This assembly enables re-entry into any Super-Mini/Super Mate combination splice without interruption of service.</p>	1/bag 12/cs.	12 each	4005-DPM/BTP
<p>> Marking Pen Use the 4039 Marking Pen for permanent marking of MS² modules for easy identification at a later date.</p>	12/box 144/cs. 0,5 (1.1)	144 each	4039
<p>> Half-Tap Cover Used to protect wire ends after the half-tap has been cut out of the MS² Super-Mini 4008 Half-Tap Module in pulp/paper and pressurized PIC cable and vault splices.</p>	12/bag 120/cs. 1,4 (3.1)	120 each	4078-C

2.1 Copper Splicing

Description - 3M™ MS²™ 10 -Pair Splice Modules and Accessories

MS² 10-Pair Super-Mini Splicing Modules



Multi-pair splicing; full wire range

The MS² 10-Pair Super-Mini Splicing Modules provide the reliability of soldered connections, plus the efficiency of multi-pair splicing in 10-pair units. This eliminates the need to strip or trim any of the individual pairs, saving time and simplifying the process.

For added convenience and efficiency, all MS² super-mini modules accept 0.35 mm - 0.9 mm (26-19 AWG) solid copper up to a maximum insulation outside diameter of 1.8 mm (0.70) PIC, pulp and paper-insulated conductors.

Solder-equivalent connections

The MS² 10-pair super-mini modules feature an array of U-shaped, phosphor-bronze contacts and stainless steel cut-off blades. As a module is crimped, each contact strips the insulation from the positioned wire and securely grips the conductor. During this crimping operation, the cut-off blades inside each module trim the excess wire. A single crimp completes a gas-tight, solder equivalent connection on all pairs in the module.

MS² 9700-10/TR Module for two-wire straight splicing

The 9700-10/TR module provides for two-wire straight splicing. Like all super-mini modules, the 9700-10 module is designed so that wire gauges and insulation types may be mixed in the module.

MS² 9700-G/TR Super Mini Module

Encapsulated Super-Mini Module for protection against humidity and condensation.

MS² 9708-10/TR Module for half-tap splicing

The 9708-10 Super-Mini Module is similar to the 9700-10 module, except that the cut-off blades have been eliminated from the bottom of the modules. This allows the through wires to be half-tapped without cutting the conductors. The wires in the base are electrically connected, but are not cut off.

Ordering Information

Description	Pkg., kg (lbs.)/ctn.	Min. Order	Ref. No.
> 10-pair Super-Mini Splicing Module (100 covers, 100 bases & 100 bodies/box)	10 boxes/ctn., 1,07 (2.35)	100 each	9700-10/TR
> Super Mini Module (encapsulated transparent) (100 covers, 100 bases & 100 bodies/box)	10 boxes/ctn., 1,34 (2.95)	1000 each	9700-G/TR
> 10-pair Super-Mini Half-Tap Module (100 covers, 100 bases & 100 bodies/box)	10 boxes/ctn., 1,06 (2.33)	1000 each	9708-10/TR
> 10-pair Super-Mini Sealant Box (20 sealant boxes & 1 applicator/box)	5 boxes/ctn., 0,28 (.61)	100 each	9777-S

International Shipments only, source of supply – 3M Germany.
Contact your local 3M Representative for additional ordering information.

2.1 Copper Splicing

Description - 3M™ MS²™ 10 -Pair Splice Modules and Accessories

MS² 9700 Series 10-Pair Super Mate Pluggable Modules



mate modules mate with other super mate modules, allowing multiple counts as necessary.

- Cut apparatus in or out without re-splicing
- Easy pair testing
- Full wire range
- Rugged design
- Ideal for lightweight tooling applications

MS² 9705-10TR Super Mate Pluggable Modules transfer without interrupting service

MS² 9705-10TR Super Mate Pluggable Modules increase productivity and reduce expenses by avoiding the time- and cost-intensive job of cutting and resplicing conductors for re-arrangements, additions, and removals of apparatus and stubs.

With super mate pluggable modules you can do it all, 10 pairs at a time, in “make before break” fashion — without interrupting service. Once a splice is in place, you have the flexibility to complete future transfers by simply plugging and unplugging the existing modules. Using simple handtools, super

MS² 9755-10 Lightweight Rig



Ordering Information

Description	Pkg., kg (lbs.)/ctn.	Min. Order	Ref. No.
> 10-pair Super Mate Pluggable Module (10 covers, 10 bases and 10 bodies/bag)	10 boxes/ctn., 1,18 (2.6)	1000 each	9705-10/TR
> Hand Presser	1/cs., 1,5 (3.4 lbs.)	1 each	4270-A
> Separator Tool	1/cs., 0,4 (2.0 lbs.)	1 each	9753-PM
> Lightweight Rig	1/ctn., 3,3 (7.3)	1 each	9755-10



International Shipments only, source of supply – 3M Germany.
Contact your local 3M Representative for additional ordering information.

2.1 Copper Splicing

Description - 3M™ MS²™ 25-Pair Modular Splicing Rigs & Equipment

MS² 25-Pair Super-Mini Splicing Modules



3M MS² splicing tools and equipment are easy to use in any kind of splicing operation, regardless of the environment or working conditions. By designing system components and techniques that are interchangeable, 3M simplifies the splicing task and reduces potential inventory headaches. Included in the system are detailed step-by-step instructions for each splicing application, user-friendly parts and components, and testing equipment to optimize splice accuracy.

Systemized splicing technology

MS² splicing simplifies wire joining and terminating operations by allowing many jobs to be performed with the same components, tools, and techniques. Any of five standard splicing rigs with MS² splicing modules could meet all your multi-pair splicing requirements in inside or outside plant — new construction, cable rearrangements or maintenance. Easily learned procedures, designed to assure both splicing accuracy and good housekeeping, make the system's components simple to master.

MS² 4021-M2/36 Splicing Rig



The 4021-M2/36 Splicing Rig is a complete splicing rig designed for one-person fold-back or inline splicing. This rig contains the 4036-25 Hand Crimper.

MS² 4049 Lite Rig



The MS² 4049 Lite Rig is a complete splicing rig and provides many features and benefits.

MS² 4026-A Module Maintenance Kit



The 4026-A Module Maintenance Kit contains the tools necessary for reentry of Super-Mini and Super Mate Modules

2. Solutions for Outside Plant

2.1 Copper Splicing

Description - MS²™ 25 -Pair Splicing Kit Components

Complete MS² Splicing Rigs and MS² Maintenance Kits

Product Number For Kits	4020-M	4021-M	4021-M/36	4021-M2/36	4049
Application	Designed for one-person fold-back or inline splicing.	A complete splicing rig designed for one-person fold-back or inline splicing. Contains 4031 Crimper.	A complete splicing rig designed for one-person fold-back or inline splicing. Contains 4036 Crimper.	A complete splicing rig designed for one-person fold-back or inline splicing. Contains 4036 Crimper.	A lightweight, portable splicing rig in a pail. Contains 4036-25. Hand/Hydraulic Tool.
Kit Components					
(can be ordered separately; see accessories)					
4049 Rig Container/Pail					1
4036 Tool Holder					1
4028 Rubbermaid Rig Case	1	1	1	1	
4036-25 Hand Crimper			1	1	1
4040 Splicing Head Assembly Includes:					
4041 Splicing Head	1	1	1	2	
Pedestal	1	1	1	1	
Traverse Clamp Assembly With Long Bar	1	1	1	1	
Head Clamp	1	1	1	1	
4041-P Splicing Head and "T" Bar Pedestal Support					1
4047 Pair Test Plug	1	1	1	1	
4051 Wire Insertion Tool	1	1	1	1	1
4052-T Tester Check Comb	2	2	2	2	1
4053 Cover Removal Tool	1	1	1	1	
Short Traverse Bar					

Ordering Information

Packaging & kg (lbs.)/cs.	Minimum Order	Ref. No.
> 11,3 (25)	1 each	4049
> 25,0 (55)	1 each	4021-M/36
> 25,4 (56)	1 each	4021-M2/36

2.1 Copper Splicing

Ordering Information

3M™ MS² 25 -Pair Modular Splicing Rigs & Accessories

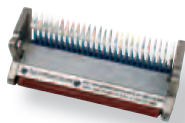

MS ² Rig Components	Pkg & kg (lbs.)/cs.	Min. Order	Ref. No.
<p>> Rubbermaid Rig Case 66 x 29.2 x 28.2 cm (26 x 11.5 x 11.1") Cube: 9.8 kg. (21.7 lbs.) Ctn. size: 67.1 x 30 x 58.4 cm (26.4 x 11.8 x 23")</p>	2/cs. 9,8 (16.5)	2 each	4028
<p>> Aerial Strand Clamp A 4035-A Aerial Strand Clamp is designed to hold a 4041-P Splicing Head in aerial splicing applications. Anchored to the suspension strand, the aerial strand clamp, clamps behind and below the splice bundle and can be used with strands from 5mm (3/16") diameter to 10 mm (3/8").</p>	1/cs. 1,7 (3.7)	1 each	4035-A
<p>> Hand Crimper The 4036 Hand/Hydraulic Crimper is a self-contained, pistol-gripped crimper designed to crimp MS² Modules in the 4041 Splicing Head.</p>	1/cs. 6,3 (13.8)	1 each	4036-25
<p>> Splicing Head Assembly This assembly contains a splicing head, a pedestal, a traverse clamp assembly with a longbar, & a head clamp for use with two manifold-back splicing.</p>	1/cs. 3,2 (7.1)	1 each	4040
<p>> Splice Head The 4041 Splicing Head is the standard MS² Splicing Head without any support components.</p>	1/cs. 1,3 (2.9)	1 each	4041
<p>> Splicing Head and "T" Bar Additional Splicing Head and "T" Bar support for use with the MS² System.</p>	1/cs. 1,7 (3.7)	1 each	4041-P

2.1 Copper Splicing

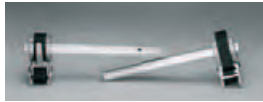

Ordering Information

3M™ MS² 25 -Pair Modular Splicing Rigs & Accessories

MS ² Rig Components	Pkg & kg (lbs.)/cs.	Min. Order	Ref. No.
<p>> Universal Splicing Head Support Assembly</p> <p>The 4045 Universal Splicing Head Support Assembly is designed to hold an MS² Splicing Head so it can be used in all applications.</p>	1/cs. 3,2 (7)	1 each	4045
<p>> Split Support Tube</p> <p>Collapsible for easy transport and set up.</p>	1/cs. 3,2 (7)	1 each	4046
<p>> Pair Test Plug</p> <p>This plug is a module probe which permits one pair checking without damaging wire insulation. The prongs fit the test entry port of all MS² modules. The cord permits easy connection to a talk block or test set.</p>	1/box 10/cs. 1,0 (2.3)	10 each	4047
<p>> Wire Insertion & Cut-Off Tool</p> <p>The 4051 tool is used on MS² modules to replace conductors back into the module.</p>	1/bag 10/cs. 0,7 (1.5)	10 each	4051
<p>> In-Head Tester Check Comb</p> <p>The check comb eliminates wiring errors by double-checking tip and ring placement prior to crimping and to insulate pairs when using the inhead tester without a cover.</p>	1/box 10/cs. 0,6 (1.5)	10 each	4052-T
<p>> Cover Removal Tool</p> <p>The 4053 Cover Remote Tool is recommended for removing either the base or cover from 25-pair Super-Mini and Super Mate Modules.</p>	1/box 10/cs. 0,4 (1.3)	10 each	4053
<p>> Separation Tool</p> <p>The only recommended tool to separate MS² Super Mate 4005-DPM/TR Modules from any other module. Note: The 4053 Cover Removal Tool cannot be used with DPM Modules.</p>	1/cs. 0,6 (1.3)	1 each	4053-PM
<p>> Hand Presser for 10- and 25-Pair</p> <p>The 4270-A presser is used to plug up to seven Super Mate Modules together.</p>	1/cs. 1,5 (3.4)	1 each	4270-A
<p>> 10/25 part splice Head</p>			9741
<p>> 9753-PM Separator Tool*</p>	1/cs. 0,4 (2.0)		9753-PM

* International shipments only, source of supply - 3M Germany.
Contact your local 3M Representative for additional ordering information.

2.2 Splice Protection Products

Description - Closures SLiC™

3M Floating Bond, 3M Rigid Bond, 3M Spiral End Seal

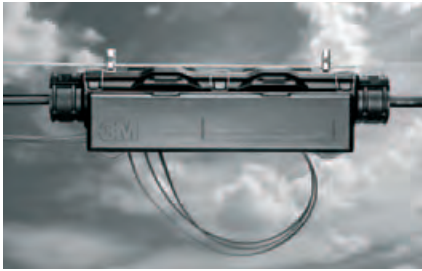

The 3M SLiC aerial closure is a single-piece aerial closure, easily installed in construction or maintenance situations. The one piece construction permits complete splice access after placement without removal of the closure or bonding from the cables. The closures are free breathing and suitable for straight, butt and branch splices of non-pressurised communication cables.

Splices are protected by the closure's double-wall moulded polyethylene construction. The durable SLiC closure will not crack or break in even the harshest environment. All components are attached to the closure.

Due to its interlocking ends, the SLiC aerial closure can expand to meet any size sheath opening without special kits, eliminating excess inventory. The 2 x 29, 3 x 33, 5 x 33, and 7 x 33 closures can be extended while maintaining their initial strength. The SLiC aerial closure does not require taping, bricking or any special labour-intensive practices. The end seals assure a snug fit on cables and eliminate the need for a drip collar. Sealing collars or tape are not required when using the SLiC closure.



The two, three, five, seven, and nine-inch diameter closures feature a universal end seal to handle any plant configuration. There are six sizes available, accommodating splice openings from 254 to 635 mm (10 to 25 inches). **RUS listed**

Fewer parts and easier installation with the SLiC Aerial Closure.

- Superior seal
- Easily adaptable
- Single piece design
- Double wall moulded construction
- Made from durable, rugged materials
- Easy to access and re-enter

Specifications

- One piece construction
- Provides easy installation; no loose parts
- Double walled, moulded construction
- Resists breaking or cracking
- Interlocking ends
- Extendible for long sheath openings
- Hanger/bonding system
- No external or additional bonding material required
- Quick release latch
- Easy re-entry
- Attached sheath retention (SR) bracket
- Protects cable sheath pull-out or movement (only for rigid bond)
- Spiral end seal
- One size fits multiple cable configurations

Scotchlok Connectors see pg. 106 - 111
Shield Bonding see pg. 126 - 127
Tapes and Sealing see pg. 186
MS² Modules see pg. 114 - 115

2.2 Splice Protection Products

Ordering Information

SLiC Aerial Closures with Floating Bond



Contains	Pkg. & kg (lbs.)/cs.	Min. Order	Ref. No.
SLiC Aerial Closure Kit with Spiral End Seal			
Spiral End Seal	1/cs., 1,0 (2.3)	1 kit	SLIC-2.2X19-SES
Spiral End Seal	1/cs., 1,7 (3.7)	1 kit	SLIC-2.6X29-SES
Spiral End Seal	1/cs., 2,0 (4.4)	1 kit	SLIC-3.6X19-SES
Spiral End Seal	1/cs., 2,4 (5.3)	1 kit	SLIC-3.6X33-SES
Spiral End Seal	1/cs., 3,8 (8.3)	1 kit	SLIC-5.6X33-SES
Spiral End Seal	1/cs., 5,0 (11.1)	1 kit	SLIC-7.6X33-SES
Spiral End Seal	1/cs., 7,5 (16.5)	1 kit	SLIC-9.6X36-SES
SLiC Aerial Closure Kit with Rubber End Seal			
2 Double Port	1/cs., 1,1 (2.4)	1 kit	SLIC-2.2X19
2 Double Port	1/cs., 1,7 (3.7)	1 kit	SLIC-2.6X29
2 Triple Port	1/cs., 2,4 (5.6)	1 kit	SLIC-3.6X33
2 Triple Port	1/cs., 3,6 (8.0)	1 kit	SLIC-5.6X33
2 Triple Port	1/cs., 4,8 (10.6)	1 kit	SLIC-7.6X33
2 Triple Port	1/cs., 7,3 (16.0)	1 kit	SLIC-9.6X36

SLiC Aerial Closures with Rigid Bond/Sheath Retention



Contains	Pkg. & kg (lbs.)/cs.	Min. Order	Ref. No.
Aerial Closure Kit with Spiral End Seal			
Spiral End Seal	1/cs., 1,1 (2.5)	1 kit	SLIC-2.2X19-SR/SES
Spiral End Seal	1/cs., 1,7 (3.7)	1 kit	SLIC-2.6X29-SR/SES
Spiral End Seal	1/cs., 2,6 (5.8)	1 kit	SLIC-3.6X33-SR/SES
Spiral End Seal	1/cs., 3,9 (8.6)	1 kit	SLIC-5.6X33-SR/SES
Spiral End Seal	1/cs., 5,1 (11.2)	1 kit	SLIC-7.6X33-SR/SES
Spiral End Seal	1/cs., 7,4 (16.3)	1 kit	SLIC-9.6X36-SR/SES

SLiC Aerial Closures with Bond Assembly attached (4462-SN)



Contains	Pkg. & kg (lbs.)/cs.	Min. Order	Ref. No.
Aerial Closure Kit with Spiral End Seal			
Spiral End Seal	1/cs., 4,3 (9.4)	4 kits	SLIC-2.2X19-BA/SES
Spiral End Seal	1/cs., 6,5 (14.4)	4 kits	SLIC-2.6X29-BA/SES
Spiral End Seal	1/cs., 9,1 (20.0)	4 kits	SLIC-3.6X33-BA/SES
Spiral End Seal	1/cs., 3,9 (8.6)	1 kit	SLIC-5.6X33-BA/SES
Spiral End Seal	1/cs., 5,0 (11)	1 kit	SLIC-7.6X33-BA/SES
Spiral End Seal	1/cs., 7,6 (16.8)	1 kit	SLIC-9.6X36-BA/SES
Aerial Closure Kit with Rubber End Seal			
2 Double Port	1/cs., 4,3 (9.5)	4 kits	SLIC-2.2X19-BA
2 Double Port	1/cs., 6,6 (14.5)	4 kits	SLIC-2.6X29-BA
2 Double Port	1/cs., 9,1 (20.0)	4 kits	SLIC-3.6X33-BA
2 Double Port	1/cs., 3,8 (8.3)	1 kit	SLIC-5.6X33-BA
2 Double Port	1/cs., 4,8 (10.5)	1 kit	SLIC-7.6X33-BA
2 Double Port	1/cs., 7,4 (16.4)	1 kit	SLIC-9.6X36-BA

2.2 Splice Protection Products

Technical Specifications

SLiC Aerial Closure Capabilities

	SLiC 2 x 19 mm (in.)	SLiC 2 x 29 mm (in.)	SLiC 3 x 19 mm (in.)	SLiC 3 x 33 mm (in.)	SLiC 5 x 33 mm (in.)	SLiC 7 x 33 mm (in.)	SLiC 9 x 36 mm (in.)
Max. Splice Opening	356 (14)	432 (17)	356 (14)	533 (21)	533 (21)	533 (21)	635 (25)
Max. Bundle Diameter	55,9 (2.2)	66 (2.6)	91,4 (3.6)	91,4 (3.6)	142,2 (5.6)	193,0 (7.6)	244 (9.6)
Approx. Cable Range Pair Count	100-pair (26 or 24 AWG) 0,4 or 0,5	**200-pair (26 or 24 AWG) 0,4 or 0,5	200-pair	*400-pair (26 or 24 AWG) 0,4 or 0,5	*1200-pair (26 AWG) 0,4	*2400-pair (26 AWG) 0,4	*3600-pair (26 AWG) 0,4
Spiral End Seal Port Capacity							
End Seal Dia. Port #1	20-41 (0.8-1.6)	20-41 (0.8-1.6)	20-66 (0.8-2.6)	20-66 (0.8-2.6)	30-76 (1.2-3.0)	38-97 (1.5-3.8)	38-97 (1.5-3.8)
End Seal Dia. Port #2	13-25 (0.5-1.0)	13-25 (0.5-1.0)	13-25 (0.5-1.0)	13-25 (0.5-1.0)	20-36 (0.8-1.4)	30-46 (1.2-1.8)	30-46 (1.2-1.8)
End Seal Dia. Port #3	13-25 (0.5-1.0)	13-25 (0.5-1.0)	13-25 (0.5-1.0)	13-25 (0.5-1.0)	36-51 (1.4-2.0)	13-30 (0.5-1.2)	13-30 (0.5-1.2)
End Seal Dia. Port #4	NA	NA	NA	NA	13-30 (0.5-1.2)	46-61 (1.8-2.4)	46-61 (1.8-2.4)
End Seal Dia. Port #5	NA	NA	NA	NA	NA	13-30 (0.5-1.2)	13-30 (0.5-1.2)
Rubber End Seal Port Capacity							
1 Port End Seal Dia. Port #1	5-41 (0.2-1.0)	5-41 (0.2-1.6)	5-66 (0.2-2.6)	5-66 (0.2-2.6)	NA	NA	NA
2 Port End Seal Dia. Port #1	5-25 (0.5-1.0)	5-25 (0.5-1.0)	5-51 (0.2-2.0)	5-51 (0.2-2.0)	20-56 (0.8-2.2)	41-81 (1.6-3.2)	41-81 (1.6-3.2)
2 Port End Seal Dia. Port #2	5-15 (0.2-0.6)	5-15 (0.2-0.6)	5-15 (0.2-0.6)	5-15 (0.2-0.6)	5-56 (0.2-2.2)	5-81 (0.2-3.2)	5-81 (0.2-3.2)
3 Port End Seal Dia. Port #1	NA	NA	5-41 (0.2-1.6)	5-41 (0.2-1.6)	15-56 (0.6-2.2)	36-97 (1.4-3.8)	36-97 (1.4-3.8)
3 Port End Seal Dia. Port #2	NA	NA	5-25 (0.5-1.0)	5-25 (0.5-1.0)	5-36 (0.2-1.4)	15-46 (0.6-1.8)	15-46 (0.6-1.8)
3 Port End Seal Dia. Port #3			5-25 (0.5-1.0)	5-25 (0.5-1.0)	5-36 (0.2-1.4)	15-46 (0.6-1.8)	15-46 (0.6-1.8)

* Based on 2-Bank Straight Splice using MS² 4000-DWP Module

** Based on more than one cable

2.2 Splice Protection Products

Description - Closures SLiC™

SLiC Aerial Terminal and SLiC Aerial Terminal with Spiral End Seal



The 3M SLiC Aerial Terminal and the SLiC Aerial Terminal with Spiral End Seal are distribution terminals and closures contained within a lightweight, double-wall moulded-plastic housing designed for fixed-count termination of aerial drop wires. Special block configurations required by the individual customer are also available and may be completed either at the factory or by the customer.

End seals of the SLiC Terminal are designed to assure proper sizing and a snug fit around the cable sheath. This eliminates the need for drip collars to prohibit water from entering the splice chamber. The

SLiC Terminal with Rubber End Seal comes packaged with singleport end seals; however, customers may use double-port or tripleport end seals as their applications require. The 7.6 cm SLiC Terminal with spiral end seal comes packaged with three port end seals. And, the 12.7 cm terminal comes packaged with four port end seals.

Specifications

- Two-closure-in-one housing design
Separates splice and drop chamber
- One piece construction
Eases installation
- Self-healing drop wire ports
Minimises weather and insect problems
- Sleeves extend in either or both directions
Eliminates need for separate rehabilitation and distribution splices; accommodates long sheath openings
- Accommodates a variety of terminating blocks
Adaptable to user requirements
- Multiple distribution counts
Counts range in multiples of 5, from 5 to 25
- Spiral end seal
One size fits multiple cable configurations

Accessories see

Shield Bonding see	pg. 126 - 127
Tapes and Sealing see	pg. 186
Scotchlok Connectors see	pg. 106 - 111
MS ² Modules see	pg. 114 - 115

2.2 Splice Protection Products

Ordering Information

Empty SLiC Aerial Terminals

Block Type	Initial Pair Capacity	Pkg. & kg (lbs.)/cs.	Min. Order	Ref. No.
Empty Terminals with Spiral End Seals				
328-MTPI-TR/SES	5 - 25	11.7 (26.0)	4	80-6113-1217-6
530-MTPI-TR/SES	5 - 25	4.1 (9.1)	1	80-6111-5693-8

Empty Housings Available with Rubber End Seals Upon Request 328 & 530 MT Housing will accommodate other manufacturer's blocks

* Blocks must be purchased from manufacturer or through your distributor.

Filled SLiC Aerial Terminals

Block Type	Initial Pair Capacity	Pkg. & kg (lbs.)/cs.	Min. Order	Ref. No.
Empty Terminals with Spiral End Seals				
328-PI-10-TR/RES	10 pair ATS block	12,0 (26.4)	4	80-6113-0396-9
328-PI-20-TR/RES	20 pair ATS block	12,0 (26.4)	4	80-6113-1044-4
328-PI-25-TR/RES	25 pair ATS block	12,0 (26.4)	4	80-6113-0397-7
328-PI-50-TR/RES	50 pair ATS block	13,8 (30.6)	4	80-6113-0399-3
530-PI-5-TR/SES	5 pair ATS block	5,0 (11.0)	1	80-6113-0708-5
530-PI-10-TR/SES	10 pair ATS block	5,0 (11.0)	1	80-6113-0705-1
530-PI-25-TR/SES	25 pair ATS block	5,0 (11.0)	1	80-6113-0707-7
530-PI-50-TR/SES	50 pair ATS block	5,1 (11.22)	1	80-6113-0709-3

NOTE: 3" SLiC terminals have an approximate splice bundle capacity of 78,7 mm (3.1"). Based on 24 AWG (0,5 mm) 2 bank straight splices using MS2 4000DWP modules; splice capacity is approximately 300 pair. 5" SLiC terminals have an approximate splice bundle capacity of 129,5 mm (5.1"). Based on 26 AWG (.4 mm) 2 bank straight splices using MS2 4000DWP modules; splice capacity is approximately 900 pair.

2.2 Splice Protection Products

SLiC Aerial Closure and Terminal Accessories

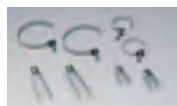

Description	Pkg. & kg (lbs.)/cs.	Min. Order	Ref. No.
3M™ SLiC™ Offset Hanger Bracket SLIC-AC-HB1	1/cs., 2,4 (5.3)	1 set/bag, 10 sets/case	80-6101-3353-2
3M™ SLiC™ Offset Hanger Bracket SLIC-AC-HB2	1/cs., 2,4 (5.3)	1 set/bag, 10 sets/case	80-6108-4677-8
SLiC Rubber End Seal Kits			
2" Single Port Rubber End Seal SLIC-ES/2SC		10 each	80-6105-8173-0
2" Double Port Rubber End Seal SLIC-ES/2DC		10 each	80-6104-1487-4
3" Single Port Rubber End Seal SLIC-ES/3SC		10 each	80-6105-8174-8
3" Double Port Rubber End Seal SLIC-ES/3DC		10 each	80-6105-8175-5
3" Triple Port Rubber End Seal SLIC-ES/3TC		10 each	80-6104-1490-8
5" Single Port Rubber End Seal SLIC-ES/5SC		5 each	80-6107-7196-8
5" Double Port Rubber End Seal SLIC-ES/5DC		5 each	80-6105-7816-5
5" Triple Port Rubber End Seal SLIC-ES/5TC		5 each	80-6104-1489-0
7" Double Port Rubber End Seal* SLIC-ES/7DC		5 each	80-6104-1699-4
7" Triple Port Rubber End Seal* SLIC-ES/7TC		5 each	80-6104-1488-2
SLiC Spiral End Seal Kits			
2" Triple Port Spiral End Seal SLIC-2-SES	10 each		80-6107-6046-6
3" Triple Port Spiral End Seal SLIC-3-SES	10 each		80-6107-6047-4
5" Four Port Spiral End Seal SLIC-5-SES	5 each		80-6107-6048-2
7" Five Port Spiral End Seal* SLIC-7-SES	5 each		80-6107-6049-0
Sheath Retention Kits			
SR-3 adds sheath retention to 3" SLiC Terminals and Closures	10/cs.	10 kits per case 1 kit per bag	SR-3
SR-5 adds sheath retention to 5" SLiC Terminals and Closures	10/cs.	10 kits per case 1 kit per bag	SR-5

2.2 Splice Protection Products

Description - 3M™ Shield Bonding Products



3M Scotchlok 4460-S Shield Bond Connector

The 4460-S Shield Bond Connector is designed to make a stable, low-resistance electrical connection between the shield of a communications cable and a conductor such as a strap, bar, or wire. The connector consists of five parts: lower member (base), upper member (top), two securing nuts (lock nuts) and a plastic shoe to aid connector insertion

and to protect conductors. The base teeth are set at such an angle as to permit easy insertion under the cable shield. Top and base members are made of tin-plated tempered brass, slightly curved to exert a continuous spring force on sheath and shield after clamping.



3M Scotchlok 4460-D Shield Bond Connector

The 4460-D Shield Bond Connector is a downsized version of the 4460 Shield Bond Connector. Its small size makes it an excellent choice for cables of 100-pair or less. Its current-carrying capacity is equal to or better than aluminum-shielded cables of 100-pair or less and can be used on all cable with 20,3 mm (0.8") or smaller O.D.



3M Scotchlok 4462 Shield Bond Connector (Designed Specifically For C.A.C.S.P. Cable)

The 4462 Shield Bond Connector is designed to make a stable, low resistance electrical connection between the shield of a communications cable and a conductor such as a strap, bar, wire or braid.



Scotch 25T Grounding Braid

This flat, tin-plated copper braid conductor is supplied for use with Scotchlok shield bond connectors. When clamped firmly, 25T Braid provides low electrical resistance connections for dependable shield bonding, and its physical strength contributes

to strain relief across spliced cables, 25T Braid is 13 mm (1/2") wide, and is supplied in 7,6 m (25') rolls.

Size: 13 mm x 7,6 m (1/2" x 25')

2.2 Splice Protection Products

Ordering Information

Shield Bonding Products

Product Name	Description	Compatible with	Packaging	Min. Order	Ref. No.
> 4460-D 3M Scotchlok™ Shield Bond Connector	The 4462-SNA shield bond connector has longer stud, deepened nuts and an insulating shoe	All fibre and copper closures	100 each per box	100 each	80-6104-1486-6
> 4460-DS 3M Scotchlok™ Shield Bond Connector	The 4460-DS connector is similar to 4460-D shield connector and is supplied with a small piece of pair saver to aid connector insertion and to protect conductors. This connector is suitable for a cable size of 100 pair or less	All copper closures	100 each per box	100 each	80-6113-1641-7
> 4462-SN 3M Scotchlok™ Shield Bond Connector	The 4462-SN shield connector is an improved version of the popular 4462 shield bond connector, with a longer and stronger stud to easily accommodate two bond braids (with eyelets)	All copper closures	500 each per box	500 each	80-6104-1542-6
> 4462-SNA 3M Scotchlok™ Shield Bond Connector	The 4462-SNA shield connector has an longer stud, deepened nuts and an insulating shoe	All copper closures	500 each per box	500 each	80-6105-8211-8
> SLIC SR-3 3M SLiC™ Sheath Retention Kit For 3" Terminals and 2", 3" Closures	Sheath Retention Kit adds sheath retention to 3" SLiC terminals and closures	All copper and fibre 3M SLiC™ closures and terminals	10 kits per box	10 kits	80-6108-6428-4
> SLIC SR-5 3M SLiC™ Sheath Retention Kit For 5" Terminals and 5", 7", 9" Closures	Sheath Retention Kit adds sheath retention to 5" SLiC terminals and closures	All copper and fibre 3M SLiC™ closures and terminals	10 kits per box	10 kits	80-6108-6429-2

Product	Packaging kg & (lbs.)/cs.	Minimum Order	Ref. No.
25T Grounding Braid			
> Size: 13 mm x 7,6 m (1/2" x 25')	1/cs., 1 (2.1)	1 roll	80610071856

2.2 Splice Protection Products

Description - 3M™ SLiC™ Aerial Terminal 319



3M SLiC Aerial Terminal 319



3M SLiC Aerial Terminal 319 with
3M IDC Block ATS/TR



3M SLiC Aerial Terminal 319 with
3M Terminal Blocks MX2000



Easy-to-open latch and place for security lock

3M SLiC Aerial Terminal 319 is an aerial, strand-mount, free-breathing terminal for copper application. The smaller size terminal can be used in inline orbutt splicing configurations and can be installed very close to a pole for easy access. A new feature of this terminal is the easy-to-open latch and place for security lock if necessary.

The 319 terminal closure is comprised of two separate chambers, a distribution cable splice chamber and a drop termination chamber. The terminal chamber is designed to accommodate up to 10-pair configurations of multi-pair (3M IDC Block ATS/TR Block) or single-pair 3M Terminal Blocks MX2000.

The double-wall molded closures are available with two types of end seals (spiral or rubber). The end seals of the SLiC terminals are designed to assure proper sizing and a snug fit around the cable sheath. This virtually eliminates the need for drip collars to prohibit water from entering the splice chamber.

The terminal can be extended easily in both directions by cutting a standard 3.6" X 33" SLiC closure in half.

Features

- One piece construction
- Separate splice and drop termination chambers
- Double-walled construction
- Quick release latches
- Interlocking ends

Benefits

- Easy installation and access to cable splice without removing the closure or terminal
- Allows easy and secure access for service connections and drop maintenance without having to enter the closure splice chamber
- Durable protection from bending and cracking in the most extreme environments
- Easy installation and re-entry without the need for special tools
- Permits the closure chamber to be extended to protect sheath damage or add extra splice capacity

The 3M IDC Block ATS/TR is a unique insulation displacement connector which contains two IDC elements and accommodates 18-24 AWG wire without stripping the insulation from the conductor.

3M Protected and Unprotected Single Pair Terminal Blocks MX2000 are designed to operate under harsh environmental conditions. This single-pair connector is designed to accommodate 18-24 AWG wire at the drop wire side and 22-24 AWG wire at the cable termination side. The connectors can be snapped on

IEC 715 25 mm and 35 mm DIN profiles.

A central disconnection area offers «both sides» testing possibilities and over voltage protection can be added when needed.

The 3M™ SLiC™ Aerial Terminals 319 are available with a MX2000 protected version also.

2.2 Splice Protection Products

Ordering Information

Product Description	Minimum Order	Ref. No.
Aerial Terminal Empty with DIN Rail for MX Block	4	80-6113-2151-6
Aerial Terminal Empty with DIN Rail for MX Block	4	80-6113-2152-4
10 Pair DIN Rail Assembly No Blocks	10	80-6113-1963-5
319-MTPI/MX/RES (Rubber End Seal) Aerial Terminal (Empty) for ATS/TR or MX Block	4	80-6113-1770-4
319-MTPI/MX/SES (Spiral End Seal) Aerial Terminal (Empty) for ATS/TR or MX Block	4	80-6113-1771-2
319-PI-10-TR/RES (Rubber End Seal) Aerial Terminal with 10 PR ATS/TR Block	4	80-6113-1772-0
319-PI-10-TR/SES (Spiral End Seal) Aerial Terminal with 10 PR ATS/TR Block	4	80-6113-1773-8
319-MX-10/RES (Rubber End Seal) Aerial Terminal with 10 PR MX Non Protected Block	4	80-6113-1774-6
319-MX-10/SES (Spiral End Seal) Aerial Terminal with 10 PR MX Non Protected Block	4	80-6113-1775-3
319-MXP-10/RES (Rubber End Seal) Aerial Terminal with 10 PR MX-Protected Block	4	80-6113-1776-1
319-MXP-10/SES (Spiral End Seal) Aerial Terminal with 10 PR MX- Protected Block	4	80-6113-1777-9
319-PI-5/RES (Rubber End Seal) Aerial Terminal with 5 Pair ATS/TR Block	4	80-6113-1950-2
319-PI-5/SES (Spiral End Seal) Aerial Terminal with 5 Pair ATS/TR Block	4	80-6113-1951-0



From left to right:
3M SLiC Offset Hanger Bracket AC-HB1,
3M SLiC Extended Hanger Bracket AC-HB2,
3M SLiC Offset Hanger Bracket AC-HB3

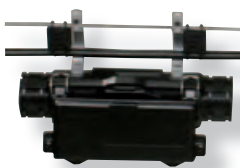

3M SLiC Aerial Terminal 319 with
3M Offset Hanger Bracket AC-HB1

Accessories

Product Description	Minimum Order	Billing Unit	Ref. No.
Aerial Closure Kit with Floating Bond and Spiral End Seal	1	Each	80-6107-6000-3
Aerial Closure Kit with Floating Bone and Rubber End Seal	1	Each	80-6104-1257-1
Spiral End Seal for 3" SLiC Closures and Terminals	10	Each	80-6107-6047-4
SLiC Closure Rubber End Seal Double Port 3"	10	Each	80-6105-8175-5
SLiC Closure Rubber End Seal Single Port 3"	10	Each	80-6105-8174-8
SLiC Closure Rubber End Seal Triple Port 3"	10	Each	80-6104-1490-8
Offset Hanger Bracket	10	Sets	80-6101-3353-2
Extended Hanger Bracket	10	Sets	80-6108-4677-8
Offset Hanger Bracket	10	Sets	80-6111-5022-0
Sheath Retention Kit for 3" SLiC Terminals and 2", 3" Closures	1	Each	80-6108-6428-4
Sheath Retention Kit for 5" SLiC Terminals and 5", 7", 9" Closures	0	Each	80-6108-6429-2

2.2 Splice Protection Products

Description - 3M™ Dome Closure

Re-enterable 3M Dome Closures with Pull 'N' Shrink Tubing (PST), offer fast and rugged splice protection, with easy re-entry



An economical method of protecting butt splices for pedestal, hand hole or pole mount applications is provided by the Re-enterable PST Dome Closures. The closure provides protection from the harmful effects of moisture, insects, and ultraviolet light, while providing no cost re-entry.

The dome closure is an easily re-enterable closure that protects the splice—without requiring special tools or heat for installation. The splice is enclosed in a split polypropylene dome which is clamped together with a steel latch and sealed with an O-ring. An expanded ethylene propylene rubber tube (PST) is slipped over the base of the enclosure and onto a gel sealing collar. Pulling a plastic rip cord on the PST allows it to shrink to the minimum outside diameter necessary to form a tight seal. The flexible tubing material conforms to the shape of the collar, sealing out both air and water.

The kit is available in four sizes, which accommodate splices from 25 to 900-pair. For encapsulated plant, three sizes are available which accommodate splices from 25- to 600-pair. RUS Listed

Specifications

- Unique latching system to secure dome to the sealed base
- Easily re-enterable, no re-entry kit, seal undisturbed at re-entry, no tools needed to re-enter
- Gel end seal
- Air tight seal over multiple cable diameters and configurations
- Retrofits existing PST
- Multiple applications

2. Solutions for Outside Plant

2.2 Splice Protection Products

Technical Specifications

for Re-enterable 3M PST Dome Closure Kits

	4604	4606	4608	4608XL
Closure Outside Dimension W x D mm (in.)	97 x 71 (3.8 x 2.8)	142 x 99 (5.6 x 3.9)	178 x 137 (7.0 x 5.4)	178 x 137 (7.0 x 5.4)
Closure Height (H) mm (in.)	572 (22.5)	572 (22.5)	597 (23.5)	851 (33.5)
Approx. Bundle Diameter mm (in.)	64 (2.5)	99 (3.9)	135 (5.3)	135 (5.3)
Minimum Reliable CAD Pedestal	CAD 4	CAD 6	CAD 8	CAD 12/70
Main Cables mm (in.)	13-28 (0.5-1.1)	23-41 (0.9-1.6)	36-64 (1.4-2.5)	36-64 (1.4-2.5)
Terminal Cables mm (in.)	10-15 (0.4-0.6)	10-15 (0.4-0.6)	10-20 (0.4-0.8)	10-20 (0.4-0.8)
Branch Cables mm (in.)	–	18-25 (0.7-1.0)	23-33 (0.9-1.3)	23-33 (0.9-1.3)
Drop Cables mm (in.)	9 max. (0.35 max.) 2 cable max.	9 max. (0.35 max.) 2 cable max.	9 max. (0.35 max.) 2 cable max.	9 max. (0.35 max.) 2 cable max.
*Approx. Splice Range	100 pr.-MS ² 50 pr.-UR2	300 pr.-MS ² 100 pr.-UR2	600 pr.-MS ² 300 pr.-UR2	900 pr.-MS ² 400 pr.-UR2

Ordering Information

Packaging & kg (lbs.)	Min. Order	Ref. No.
15/cs. 17,0 (37.5)	15 kits	4604
9/cs. 15,6 (34.4)	9 kits	4606
5/cs. 12,2 (26.8)	5 kits	4608
5/cs. 15,3 (33.7)	5 kits	4608XL

***NOTE:** Based on 2 bank MS2 4000-DWP Modules and Scotchlok Connectors installed per 3M practices. Examples: 100-pair means 100-pair In and 100-pair Out or 100 pair straight splice.

Kit components included: Closure Assembly, Dome, Base, O-Ring, Latch, Gel End Seal, Ground Wires, P.S.T. Sheath Scuff, Desiccant Bag.

Companion products needed: Scotch 88T 38 mm (1-1/2") Wide Vinyl Tape, 130C LR Rubber Tape, Scotchlok 4460 Series Shield Bond Connectors, Scotchlok UR2 or MS² Splice Connectors, 6228 Cable Ties, 381 mm (15").

Accessories

Product Description	Size cm (in.)	Pkg. & kg (lbs.)	Min. Order	Ref. No.
Pull N' Shrink Tubing	11,4 x 13,3 (4.8 x 5.25)	5/cs., 2,4 (5.5)	5 each	4604-PST
Pull N' Shrink Tubing	14,6 x 15,8 (5.75 x 6.25)	5/cs., 4,0 (8.92)	5 each	4606-PST
Pull N' Shrink Tubing	18,4 x 18,4 (7.25 x 7.25)	5/cs., 9,4 (20.78)	5 each	4608-PST
Gel Sealant Strip	6,3 x 50,7 (2.5 x 20)	50/cs., 9,4 (20.78)	50 each	4600-GSS
Non-Indicating Desiccant Bags	–	100/cs., 3,6 (8.0)	100 each	4600-NID

2.2 Splice Protection Products

Description - 3M™ OS Closures



OSS and OSL closures are one piece, tool-free, one-hand / one operation, small size, mechanical, copper cable splice closures. Simply pressing the two shelves of the closure together by hand, closure locks and seals the splice. Closure body is made out of thermoplastic material and the sealing is a patented gel. Splice area in the middle of the closure is non-filled and the sealing material is surrounding the splice cell. Top shelf and bottom shelf of the closure are hinged from the back edge and when the closure is closed, sealing gel on the top and the bottom shelves meet/compress each other by sealing the cable entries automatically. "Cable Tie" and/or "special design build-in strain relief" provide cable retention. The design of the closure allows re-entries by simply unlatching the locking mechanism.

OSS closure is mainly for 2/4 pairs splices (w Scotchlok™ U/U2) protection and OSL closure is mainly for up to 10 a pairs splice (w Scotchlok U/U2) protection. OSL can be perfectly used with MS² 10 pairs module, too.

Both closures are, having IP67 protection class, suitable for UG (direct buried) applications as well as the overhead applications, which may require lower protection class.

Specifications

- Mechanical
- Easy to install
- UV resistant and IP 67 protection
- Non-craft sensitive and reliable
- Re-enterable
- Splice area is dry (no gel filling)
- Up to 10 pairs application with Scotchlok™ and MS²™
- Cylindrical design
- No deformation on the sealing area or splice area after the closure installation

Ordering Information



	Ref. No.
<p>> OSSC One Step Small Closure 1 to 1 Chicane version Packaging: 10ea in a carton box w installation instructions.</p>	N501425A
<p>> OSSC One Step Small Closure 1 to 2 Chicane version Packaging: 10ea in a carton box w installation instructions.</p>	N501454A
<p>> OSSC One Step Small Closure 1 to 1 Cable Tie version Packaging: 10ea + 20ea cable ties in a carton box w installation instructions.</p>	N501425B
<p>> OSSC One Step Small Closure 1 to 2 Cable Tie version Packaging: 10ea + 20ea cable ties in a carton box w installation instructions.</p>	N501454B
<p>> OSLC One Step Large Closure 2 to 2 Packaging: 1ea w 4ea cable ties & 4ea spring force s/b connectors in a bag / 10 bags in a carton box w installation instructions.</p>	N501426A

2.2 Splice Protection Products

Description - 3M™ One Step Closure 30 pairs OSC30

The OSC30 is a mechanical closure with a gel gasket to protect dry splices in the closure cavity. Its waterproof IP68 design makes it ideal for use within the telecommunications distribution network and on copper cables up to a maximum of 30 pairs.

The innovative latching mechanism the closure allows for it to be installed and if necessary, re-opened quickly and easily. The OSC30 is intended to be used as an alternative product to heat shrink sleeves, resin closures, and other small closures or boxes.

The OSC30 can be used for inline, butt or branch splicing and follows standard installation procedures.

The gel used within the OSC30 is a two part silicone, semi-hard and along with the design of the closure ensures that it meets the requirements of IP68. There are 2 cable ports at each end of the OSC30,

- > one smaller port for cables of diameters between 8-13 mm
- > one larger port for cables of a diameters between 13-18 mm.

This range allows for the usage of any copper cables between 8 and 30 pairs.

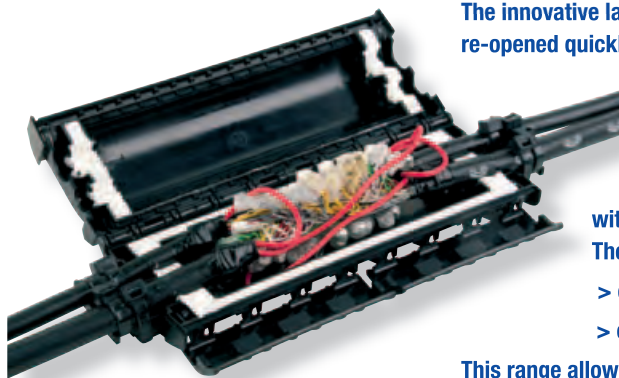

Features

- Mechanical locking
- Ease of installation
- UV resistance and IP68 watertightness
- Ease of use and reliable sealing
- Easy to re-open / close to access the splice
- Dry splice chamber

Benefits

- No extra energy (Gas, Flame etc.)
- Fast installation time
- Can be used in Aerial, direct buried or manholes
- Simple and secure installation
- Low / no maintenance cost
- No extra support needed

Ordering Information



> OSC30 Mid Span Closure

Packing: 1 Kit = 1 closure and 10 cable ties in a plastic-bag
1 Packaging Unit = 10 kits in a cardboard box with 1 instruction manual

Ref. No.

N501652A

2.2 Splice Protection Products

Description - 3M™ Distribution Closure BDR

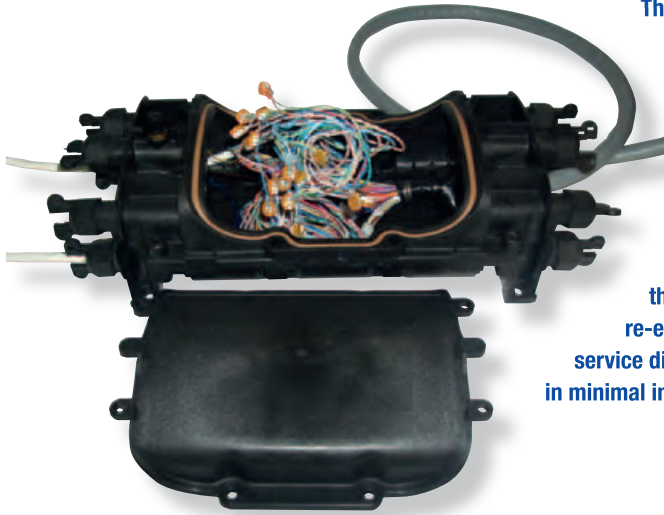

The BDR closure is a mechanical, underground distribution closure – it enables an aesthetic and environmentally safe, fully underground network.

The BDR's "2-in-1" design incorporates a closure and distribution box in one, allowing for up to ten tool-less, sealed 2/4 cable entry ports. This, in addition to its ability to be configured with a variety of different termination blocks and use a variety of splice configurations, allows for greater flexibility to the service provider. The removable cover enables easy and no-cost re-entry and gives access to the inside of the terminal without the risk of service disruption. No special tooling is required to install and reenter, resulting in minimal incremental investment.

Specifications

- Cover
- Casing
- Guard
- Butyl bead
- Packaging bag
- Bag of alcohol
- Butyl roller
- Cable ties
- Cable grip
- Gauge

Features

- Standard Tool Operated
- Gasketed Mechanical Closure
- Multi-purpose Applications
- Removable cover for re-entry
- 10, Tool-less, sealed 2/4 cable entry ports
- RoHS Compliant

Benefits

- No specific tool or training needed, no additional investment required
- Requires no resin, torch, power or chemicals, easy to re-enter and reuse – safer, easier and quicker to install – increased productivity & no cost re-entry
- Can be configured with many different termination blocks and allows for many kinds of splicing configurations (butt, inline, branch, distribution, etc. . .) – gives customer flexibility and versatility in designing network
- Gives access to the inside of the terminal without disrupting the main cable – reduces errors resulting in service disruptions
- Easy to connect and disconnect – great flexibility to service provider

2.2 Splice Protection Products



Specifications

- External dimensions (L x W x H): 350 mm x 150 mm x 100 mm
- Internal dimensions (L x W x H): 180 mm x 110 mm x 75 mm
- Colour: black
- Internal volume: 1.53 dm³
- Diameter main cable: 5 mm - 20 mm
- Diameter cable exit: 4 mm - 12 mm
- Protection: IP68 / IK 06
- •Valve for flash test (optional)

Ordering Information

Description	Ref. No.
> 3M Distribution Closure BDR Quick Guide	N501363A

2.2 Splice Protection Products

Description - 3M™ Pressurised Closures 50/51P Series



3M Pressurised Closure System 50/51P-Series

The 3M Pressurised Closures 50/51P Series offers a complete pressure-tight closure system for protecting spliced communication cables in a wide range of applications.

Features

- Constructed from impact and corrosion resistant plastic
- Grounding harness is pre-attached to the closure half
- Provides ultra-violet protection
- Available with internal or external sheath retention
- All assembly bonding and mounting hardware is included in kit
- Lightweight
- Pressure tight
- Reenterable and reusable
- Piece parts available
- No special tools required for assembly or re-entry

Applications

- Aerial
- Handhole
- Underground

Sizes

- Seven sizes will accommodate cable diameters for 0.4" (10 mm) to 2.8" (71 mm) and splices up to 1500 pairs
- May be used for sheath openings of 13" (330 mm) or less to a maximum of 19" (483 mm)
- Available in straight or branch splice configurations

Specifications

Product Number	Sheath Opening In. (mm)	Max. Cable Sheath Dia. 24. Ga.	Max. Number of Cable Pairs 26 Ga.	Inside Diameter In. (mm)	(L) Length In. (mm)	(H) Height In. (mm)	(W) Width In. (mm)
General product features							
50AA3P-510	13" (330)	1.0" (25)	100 100	2.0" (51)	21.5" (546)	4.5" (114)	3.25" (83)
50B3P-510	19" (483)	1.6" (25)	300 400	3.25" (83)	28.5" (724)	6.0" (152)	4.0" (102)
50C3P-510	19" (483)	2.2" (25)	600 900	4.5" (114)	28.5" (724)	7.5" (191)	5.0" (127)
50D3P-510	19" (483)	2.8" (25)	1200 1500	6.25" (159)	28.5" (724)	9.25" (235)	6.75" (171)
For Branch Splice Configurations							
51AA3P-510	13" (330)	1.0" (25)	100 200	3.0" (76)	21.5" (546)	5.5" (140)	4.5" (114)
51B3P-510	19" (483)	1.6" (25)	400 600	5.0" (127)	28.5" (724)	8.0" (203)	5.5" (140)
51D3P-510	19" (483)	2.8" (25)	1500 1800	7.25" (184)	28.5" (724)	10.25" (260)	7.75" (197)

* Maximum number of cable pairs based on using 25-pair modular connectors for in-line splice.
Note: 24 gauge = 0.51 mm, 26 gauge = 0.40 mm

Kit contents:

1. Cover assembly with bond braid and insulation (attached)
2. Universal slotted washers for sealing cable entrances and internal sheath retention
3. Foam tape for internal sheath retention
4. Internal sheath retention assembly
5. Sealing tape for cable collar build up
6. 3M™ Scotchlok™ Shield Bond Connectors
7. External grounding ribbon
8. Pressure valve with nut and washer
9. Sealing cord for sealing cover halves
10. Transparent splice wrap
11. Cable ties to secure transparent wrap
12. Cable ties to secure back cover half
13. Aerial hanger assembly
14. Solid bond connector and nut
15. Solvent cleaning wipes
16. Plastic gloves
17. Cable sheath scuff
18. Cable diameter measuring tape
19. Installation instructions (not shown)



3M Pressurised Closure 50/51P-Series

2.2 Splice Protection Products

Tools Required (not included with closure kits)

- 3M™ Washer Cutter Tool WCT11K
- Screwdriver
- Snips
- Speed wrench
- Knife
- Tabbing shears
- Can wrench with 3/8" (9.5 mm) and 7/16" (11 mm) ends
- Torque wrench (250 in•lbs) (2.9 kg•m)
- 3" socket extender
- 1/2" (13 mm) and 7/16" (11 mm) deep wrench sockets

Ordering Information

Product	Ref. No.
> 3M™ Pressurized Closures 50/51P Straight Splice Configuration, Inside Diameter 2.0 in (51 mm)	50AA3P-510
> 3M™ Pressurized Closures 50/51P Straight Splice Configuration, Inside Diameter 3.25 in (83 mm)	50B3P-510
> 3M™ Pressurized Closures 50/51P Straight Splice Configuration, Inside Diameter 4.5 in (114 mm)	50C3P-510
> 3M™ Pressurized Closures 50/51P Straight Splice Configuration, Inside Diameter 6.25 in (159 mm)	50D3P-510
> 3M™ Pressurized Closures 50/51P Branch Splice Configuration, Inside Diameter 3.0 in (76 mm)	51AA3P-510
> 3M™ Pressurized Closures 50/51P Branch Splice Configuration, Inside Diameter 5.0 in (127 mm)	51B3P-510
> 3M™ Pressurized Closures 50/51P Branch Splice Configuration, Inside Diameter 7.25 in (184 mm)	51D3P-510
Accessories	
> 3M™ Aerial Hanger Kit	AH20K
> 3M™ Tool Kit Washer Cutter 3	WCT11K
> 3M™ Closure Tool Kit for 2-Type	2-TYPE/TK
> 3M™ Kit Ant Repellent 50/51	ARK0-26
> 3M™ Bonding and Grounding Kit for 699 mm (27.5 in) length cover	BG10K
> 3M™ Bonding and Grounding Kit for 470 mm (18.5 in) length cover	BG9K
> 3M™ Unthreaded Jackplate Kit	CIT68-4K
> 3M™ Threaded Jackplate Kit	CIT68K
> 3M™ Cleaning Wipes	CSSC20-M100
> 3M™ Universal Sealing Washer, 2 Pack	FS-B-M200
> 3M™ Pressure Valve Kit	FVA11K
> 3M™ Plugging Spool for 1.0" Cable Opening	FX-K
> 3M™ Universal Sealing Washer, 2 Pack	GS-B-M200
> 3M™ Plugging Spool for 1.6" Cable Opening	GX-K
> 3M™ Universal Sealing Washer, 2 Pack	HS-B-M200
> 3M™ Plugging Spool for 2.2" Cable Opening	HX-K
> 3M™ Universal Sealing Washer, 2 Pack	JS-B-M200
> 3M™ Plugging Spool for 3.4" Cable Opening	JX-K
> 3M™ Reenterable Sealing Cord R/V8 .305x45	RC45-8
> 3M™ Reenterable Sealing Cord R/V8 .305x62	RC62-8
> 3M™ Reenterable Sealing Tape R/V8 1-1/2x36	RTW36-8
> 3M™ Reenterable Sealing Tape R/V8 1-1/2x72	RTW72-8
> 3M™ Kit Bolt long 50/51 1/4	SB4LK
> 3M™ Shield Connector Kit, BCP1-1, size #1, up to 20 mm (0.8 in) cable diameter	SC10K
> 3M™ Shield Connector Kit, BCP2-1, size #2, 20 mm (0.8 in) to 41 mm (1.6 in) cable diameter	SC20K
> 3M™ Kit Washer Cutter Blade	WCB11K
> 3M™ Tool Kit Washer Cutter 3	WCT11K

2.2 Splice Protection Products

Description - 3M™ Pressurised Closure System 2-Type 505



3M Pressurised Closure System 2-Type 505

The 3M Pressurised Closure System 2-Type 505 is a complete, pressure-tight, reenterable closure system for enclosing spliced connections of communications cable in a wide variety of applications. The 2-Type closure is offered in seven different diameter sizes (3-inch to 12-inch) and 13 different lengths (18.5" to 82.5"). Custom length closures up to 108 inches in length are available upon request.

The tools required for installation are a washer cutter tool and a torque wrench. This system allows for quick and easy re-entry of closures.

Features

- Pressure tight
- Re-enterable
- Industry common tools used for assembly or re-entry
- Constructed of impact- and corrosion-resistant plastic
- Craft friendly
- Reusable
- More than 25-year field history
- Used in aerial, underground and manhole applications
- Custom lengths available
- Suitable for straight and branch splice configurations
- C, D and E sizes can handle more than 4200 pairs

3M Closure System 2-Type 505-Cover



Each Complete 2-Type Cover 505 Selection Contains:

1. Cover halves with installed sealing gasket
2. Protective gloves
3. 3M Sealing R-Tape
4. 3M Dry Towlette Wipe DTW
5. Alignment bars
6. Alignment bar hardware
7. Back cover clips
8. Flanged hex nut
9. Hex nuts
10. Pressure valve
11. 3M Cleaning Wipes CSSC20
12. External ground ribbon
13. Black cable ties
14. Bond braid with eyelets
15. White cable ties
16. Splice wrap

2.2 Splice Protection Products

3M Closure System 2-Type 505-Endplates



Each Complete 2-Type Endplate 505 Selection Contains

1. Endplate sections
2. Sheath scuff
3. 3M Sealing Tape RTW
4. Protective gloves
5. Cable diameter tape
6. Sealing washers
7. Additional longer cable retention clamps (depending upon endplate ordered)
8. 3M Sealing Tape RTE
9. 3M Scotchlok™ Shield Bond Connectors
10. Hose clamps
11. 3M Cleaning Wipes CSSC20

Features

- Constructed from impact and corrosion resistant plastic
- Grounding harness is pre-attached to the closure half
- Provides ultra-violet protection
- Available with internal or external sheath retention
- All assembly bonding and mounting hardware is included in kit
- Lightweight
- Pressure tight
- Reenterable and reusable
- Piece parts available
- No special tools required for assembly or re-entry

Tools required

- Aerial
- Handhole
- Underground

Sizes

- Seven sizes will accommodate cable diameters for 0.4" (10 mm) to 2.8" (71 mm) and splices up to 1500 pairs
- May be used for sheath openings of 13" (330 mm) or less to a maximum of 19" (483 mm)
- Available in straight or branch splice configurations

2.2 Splice Protection Products

Ordering Information

Product	Ref. No.
> 3M™ Plugging Spool for 1.6" Cable Opening	GX-K
> 3M™ Plugging Spool for 2.2" Cable Opening	HX-K
> 3M™ Plugging Spool for 3.4" Cable Opening	JX-K
> 3M™ Plugging Spool for 3.4" Cable Opening	KX-K
> 3M™ Plugging Spool for 4.0" Cable Opening	LX-K
> 3M™ Plugging Spool for 4.4" Cable Opening	MX-K
> 3M™ Universal Sealing Washer, 2 Pack	FS-B-M200
> 3M™ Universal Sealing Washer, 2 Pack	GS-B-M200
> 3M™ Universal Sealing Washer, 2 Pack	HS-B-M200
> 3M™ Universal Sealing Washer, 2 Pack	JS-B-M200
> 3M™ Universal Sealing Washer, 2 Pack	KS-B-M200
> 3M™ Universal Sealing Washer, 2 Pack	LS-B-M100
> 3M™ Washer Stepdown Package	MK-K
> 3M™ Universal Sealing Washer, 2 Pack	MS-B-M100
> 3M™ Channel Bar with Threaded Insert, A Length	CTB10K
> 3M™ Channel Bar with Threaded Insert, B Length	CTB11K
> 3M™ Channel Bar with Threaded Insert, C Length	CTB12K
> 3M™ Channel Bar with Unthreaded Insert, B Length	CUB11K

2.2 Splice Protection Products

Description - 3M™ Encapsulated Closures



Better Buried Closures

Encapsulated Closures enclose cable plant splices in direct buried, hand hole, and man hole applications. They also protect cable splices from environmental elements found in these applications and enclose a variety of cable configurations.

The closures are also used to easily accommodate distribution drops from the main cable. The methods used in encapsulated closures have evolved from early gravity filled methods to compound compression methods.

The Better Buried and 89 Series Closures use a gravity fill method of encapsulating and protecting the cable splice. Both kits are simple to install and are offered with a full product offering to cover the complete cable ranges found in the outside plant. In addition, both kits can be ordered with 8882 High Gel re-enterable encapsulant.

The 89 Series can also be purchased with 4407 Encapsulant for making a permanent, hard encapsulated closure with maximum water protection.



Foam Sealed Closure

3M Buried Compound Compression

The Better Buried Compound Compression Closure method forces the encapsulant up the cable core to stop water ingress. The product is simple to install, comes with the spacer web and plastic wrap and is used to hold and force the encapsulant. The product is offered in different sizes to cover various cable ranges and can be easily extended and bricked.

3M Foam Sealed Closure

Foam Sealed Closures use the Compound Compression method to apply the pressure to the encapsulant. The polyethylene closure body is over wrapped with the armorcast structural material for physical strength. 3M 4411 expandable sealant is used to fill the void between the closure body and the compound compression splice. The expandable foam adheres to the closure body, E-Z wrap and the cable sheath which in turn provides a water tight barrier around the splice and cables entering the closure.

Specifications

- Few loose parts
- Easy assembly and improved productivity
- No heat required
- Eliminate safety concerns
- Adjustable closure diameter
- Minimises compound usage and total cost
- Tough outer shell
- Can be used in harsh environments
- Rigid body closure
- Easy re-entry, physical strength
- Rigid bonding assembly
- Increased physical strength, provides more support to the cable
- Solvent resistant
- Gasoline won't erode expandable foam and armorcast
- Can be cut with a zip cord
- Can be extended easily
- No need to stock different sizes
- Total kit
- No need to order individual parts, reduces total cost

2.2 Splice Protection Products

Technical Specifications



3M Foam Sealed Closure with Compound Compression

Key required accessories include:

3M Scotchlok connectors for closure dimension less than 3x12. Anything larger, a module is required.

Terminal or Closure: Closure

Free Breathing or Sealed: Sealed

Preference of Seal: Encapsulated

Kit Contents:

Scotchlok™ shield bond connector 4460-D, Closure Body Assembly, Insulated Bond Strap, Armorcast Structural Material, Cleaning Pad, Scotch Foam Collar Tape 26-FC, Protective Gloves, Scotchlok 4462 Shield Bond Connectors, 3M™ E-Z Wrap Elastic Vinyl Tape 2183, Body web with plastic liner, Cable Ties, 3M™ Scotchcast™ Sheath Scuff PNO4435, Rip Wires, Vinyl Tape 3/4 Wide, 8882 High Gel Encapsulant (without encapsulant), 3M™ Scotchcast™ Pedestal Base Sealant Kit 4411 (without encapsulant)

Features	FSC 2X12/ CC10-25PR	FSC 2X12/ CC-W/O-HIGH-GEL/S	FSC 3X12S/ CC-W/O-HIGH-GEL/S	FSC 3X12L/ CC-W/O-HIGH-GEL/S	FSC 3X19/ CC-W/O-HIGH-GEL/S	FSC 4X19/ CC-W/O-HIGH-GEL/S	FSC 6X19/ CC-W/O-HIGH-GEL/S	FSC 3X19/ CC-W/O-HIGH-GEL	FSC 3X12S/ CC-W/O-HIGH-GEL	FSC 2X12/ CC-W/O-HIGH-GEL
Maximum Pair Count (using 25-pair modular connectors)	0	0	100	200	400	600	1200	400	100	0
Maximum Pair Count (using 3M™ Scotchlok™ Connector Splice UY2)	25	25	75	200	400	600	1200	400	75	25
Wire Gauge	22	22	24	24	24	24	24	24	24	22
Encapsulant Included	4411, 8882-A	4411	4411	4411	4411	4411	4411	4411	4411	4411
Additional Required Encapsulant	None	8882-A	8882-C	8882-750C	8882-1500/F	8882-1900C, 8882-500C	8882-500C, 8882-D	8882-1500/F	8882-750C	8882-A
Approx. compound required ml (g)	165-150	165-150	385-350	769-700	1648-1500	2473-2250	5769-5250	1648-1500	385-350	165-150
Splice Bundle Diameter	1.25 inches	1.25 inches	2.0 inches	3.0 inches	3.0 inches	3.9 inches	5.70 inches	3.0 inches	2.0 inches	1.25 inches
Sheath Opening	9.0 inches	9.0 inches	10.0 inches	10.0 inches	17.0 inches	17.0 inches	19.0 inches	17.0 inches	10.0 inches	9.0 inches
Shield Bond Connector Included	Yes	No	No	No	No	No	No	Yes	Yes	Yes

Ordering Information

	Ref. No.
> Foam Sealed Closure FSC2X12/CC10-25PR	80-6113-1409-9
> Foam Sealed Closure FSC2X12/CC-W/O-HIGHGEL/S	80-6111-5846-2
> Foam Sealed Closure FSC3X12S/CC-W/O-HIGHGEL/S	80-6111-5847-0
> Foam Sealed Closure FSC3X12L/CC-W/O-HIGHGEL/S	80-6111-5848-8
> Foam Sealed Closure FSC3X19/CC-W/O-HIGHGEL/S	80-6111-5849-6
> Foam Sealed Closure FSC4X19/CC-W/O-HIGHGEL/S	80-6111-5851-2
> Foam Sealed Closure FSC6X19/CC-W/O-HIGHGEL/S	80-6111-5853-8
> Foam Sealed Closure FSC3X19/CC-W/O-HIGHGEL	80-6110-2019-1
> Foam Sealed Closure FSC3X12S/CC-W/O-HIGHGEL	80-6110-2021-7
> Foam Sealed Closure FSC2X12/CC-W/O-HIGHGEL	80-6110-2022-5

2.2 Splice Protection Products

Description - 3M™ Better Buried Closures

Buried Compound Compression/Gravity Fill Closure



3M Better Buried Closure

The 3M Better Buried Closure's versatile design meets most cable size requirements for buried inline, tap, butt splices, cable and sheath repair. Eight standard sizes and five end cap configurations allow you to protect buried splices of almost any practical length and diameter. Better buried closures use compound compression or a gravity fill method of encapsulating and protecting the cable splice. Better Buried Closures use either 3M MS² 25-pair Splicing Module or 3M Scotchlok Connector UR2/UR.

Product Features



Kit for 3M Better Buried Closure

Better Buried End Caps

Tapered end caps can be trimmed and slit for exact cable size required. Single, double and triple entry styles are available dependent on size. When adding a branch cable to an existing cable, grooved end caps can be easily split in the field and quickly released with Locking "H" strips provided in each kit.

3M Scotchcast Strain Relief Bars

Strain relief bars can be installed on a simple or double sheath cable to protect the splice from electrical interference and damage from the cable tension. The aluminum strain relief bar assemble includes hose clamps and an insulation sleeve.

3M Scotchcast Spacer Web 4430

Spacer web is designed to protect splice connectors by positioning them away from the closure walls. Better coverage is achieved because compound flows around the complete bundle.

- Protects splice components
- Enhanced coverage

Hose Clamps

Hose clamps secure the closure body and end caps.

- Corrosion resistant
- Easy to install
- Re-enterable

3M™ Better Buried Closures Product Specifications

Closure Size	Closure End Cap Port Diameters				Maximum Splice Openings			Approx. Amount of Comp. Required (Ave. Splice)
	Single Entry (Max.)	1	Multiple Entry (Max.)		Singl Sheath	Double Sheath		
			2	3		Outer	Inner	
2" x 12" (50 x 305 mm)	1.2" 30 mm	1.2" 30 mm	0.7" 18 mm	–	5" 127 mm	–	–	400
2" x 24" (50 x 610 mm)	1.2" 30 mm	1.2" 30 mm	0.7" 18 mm	–	17" 432 mm	17" 432 mm	14" 356 mm	400
3" x 24" (76 x 610 mm)	1.6" 41 mm	1.6" 41 mm	1.0" 25 mm	–	17" 432 mm	17" 432 mm	14" 356 mm	24
4" x 24" (102 x 610 mm)	2.0" 51 mm	2.0" 51 mm	1.5" 38 mm	–	17" 432 mm	17" 432 mm	14" 356 mm	4411
5" x 26" (127 x 660 mm)	2.4" 61 mm	2.4" 61 mm	1.8" 46 mm	–	17" 432 mm	17" 432 mm	16" 406 mm	8882-1500/F
6" x 26" (152 x 660 mm)	3.3" 84 mm	2.7" 68 mm	2.0" 50 mm	1.5" 40 mm	19" 483 mm	19" 483 mm	16" 406 mm	1648-1500
7" x 26" (178 x 660 mm)	3.5" 89 mm	3.5" 89 mm	2.2" 56 mm	2.2" 56 mm	19" 83 mm	19" 83 mm	16" 406 mm	3.0 inches
9" x 26" (229 x 660 mm)	4.0" 102 mm	4.0" 102 mm	2.5" 64 mm	2.5" 64 mm	19" 483 mm	19" 483 mm	16" 406 mm	17.0 inches

2.2 Splice Protection Products

Maximum Splice Bundle Capacities

Connector	2" x 12" 50 x 305 mm	2" x 24" 50 x 610 mm	3" x 24" 76 x 610 mm	4" x 24" 102 x 610 mm	5" x 26" 127 x 660 mm	6" x 26" 152 x 660 mm	7" x 26" 178 x 660 mm	9" x 26" 229 x 660 mm
3M MS ² Splicing Module 4000-DWP	50 pair 0.5 mm (24 AWG) UY Only	100 pair 0.5 mm (24 AWG)	200 pair 0.5 mm (24 AWG)	400 pair 0.5 mm (24 AWG)	600 pair 0.5 mm (24 AWG)	900 pair 0.5 mm (24 AWG)	1200 pair 0.5 mm (24 AWG)	2400 pair 0.4 mm (24 AWG)
3M Scotchlok Connectors UR (w/ 3" pigtails)	25 pair 0.6 mm (22 AWG)	50 pair 0.6 mm (22 AWG)	100 pair 0.6 mm (22 AWG)	200 pair 0.6 mm (22 AWG)	300 pair 0.6 mm (22 AWG)	400 pair 0.6 mm (22 AWG)	600 pair 0.6 mm (22 AWG)	900 pair 0.6 mm (22 AWG)

3M™ Better Buried Closure Kit Concept

All Better Buried closures are packaged in a kit to create a "one number" ordering system, which helps reduce inventory maintenance and helps reduce the

chance of ordering incorrect components. For special applications, components can be ordered separately.

3M™ Better Buried Closures Kit Components

Kit Components	B.B. SB/ 2SC 2"-5" (50- 127 mm)	B.B. SB/ SC, DC 2"-5" (50- 127 mm)	B.B. SB/ 2DC 6"-9" (152- 229 mm)	B.B. SB/ DC, TC 7"-9" (178- 229 mm)	B.B. Sleeve Kit 2"-9" (50- 229 mm)
Closure body	1	1	1	1	1
End cap, single (SC)	2	1			
End cap, multiple (DC) (TC)	1	2	2		
Spacer web (SW)	1	1	1	1	1
Strain relief bar (SB)	1 or 2	1 or 2	2	2	
Hose clamps, closure	3	3	3	3	3
Hose clamps, strain bar	2	2	2	2	
Funnel	1	1	1	1	1
Snap-in cap	2	2	2	2	2
Locking «H»	2	3 or 4	4	5	
Foam strips	1	1	1	1	

3M™ Better Buried Closure Kits with 3M™ High Gel Re-enterable Encapsulant 8882

Better Buried Series closure kits with 8882 High Gel are available in five sizes that contain all* the

components needed to complete the installation process.

*except modules, which can be ordered separately

2.2 Splice Protection Products

Technical Specifications

Complete Kits

Encapsulated: Yes
 Re-enterable: Yes
 Encapsulation Method: Gravity Pour

Kit Contents:
 3M Scotchlok Shield Bond Connectors 4460-D or 4462-FN, 3M Better Buried Sleeve Kits (Closure Extension), 3M High Gel Reenterable Encapsulant

8882, Hose Clamps, Scotch® Vinyl Tape 88T, 3M Scotchcast Spacer Web 4430 (for re-entry only), DR Tape, Sheath scuff material, Scotch® Linerless Rubber Splicing Tape 130C, 3M Scotchcast Pair Saver 4458 or 4458W, Scotch® Rubber Splicing Tape 23, 3M Scotchcast Strain Relief Bar Kits 4465 or 4465-L, B Sealing Tape, Bonding Braid, 3M Better Buried End Caps (bulk), Funnel, Closure Body

Features	BB2X12-8882/HIGHGEL	BB2X24-8882/HIGHGEL	BB3X24-8882/HIGHGEL	BB4X24-8882/HIGHGEL	BB5X26-8882/HIGHGEL
Splice Bundle Diameter	2.0 inches	2.0 inches	3.0 inches	4.0 inches	5.0 inches
Maximum Splice Opening	7.0 inches	17.0 inches	17.0 inches	17.0 inches	19.0 inches
Closure Length End-to-End	16.0 inches	28.0 inches	28.0 inches	30.0 inches	30.0 inches
Maximum Pair Count (using 25-pair modular connectors)	50 pair	100 pair	200 pair	400 pair	600 pair
Maximum Pair Count (using 3M Scotchlok Connector UR2/UR)	25 pair	50 pair	100 pair	200 pair	300 pair
Approximate Compound Required ml (g*)	660 (600)	1,320 (1,200)	3,300 (3,000)	4,500 (5,000)	7,200 (8,300)

3M™ Better Buried Closure Kits with 3M™ High Gel Re-enterable Encapsulant 8882 include the following materials:

- 3M Scotchlok Shield Bond Connectors
- 3M Better Buried Sleeve Kits (Closure Extension)
- 8882 High Gel Encapsulating Compound (re-enterable)
- Hose clamps
- Scotch® Vinyl Tape 88T
- 3M Scotchcast Spacer Web 4430 (for re-entry only)
- DR Tape
- Sheath scuff material
- Scotch® Linerless Rubber Splicing Tape 130C
- 3M Scotchcast Pair Saver 4458 or 4458W
- Scotch® Rubber Splicing Tape 23
- 3M Scotchcast Strain Relief Bar Kits 4465 or 4465-L
- B Sealing Tape
- Bonding braid
- 3M Better Buried End Caps (bulk)
- Funnel
- Closure body

2.2 Splice Protection Products

Better Buried Closures

To order Better Buried Gravity Filled Closures follow 2 easy steps:

Step 1:

Determine closure size using type of pair capacity and maximum opening. (i.e. = BB2 x 12)

Step 2:

Using closure size from Step 1, determine splice and cable configuration code. (i.e. = SB/2SC-LHS)
(Combine steps 1 and 2 to determine product number (i.e. = BB2 x 12 SB/2SC-LHS))

Product Nomenclature

BB = Better Buried	SC = Single Port End Cap
FC = Flat Cap	SB = Strain Relief Bond Bar
DC = Double Port End Cap	PC = Puddle Cap
SW = Spaces Web	TC = Triple Port End Cap
LHS = Locking Harness System	DS = Double Sleeve

Ordering Information

	Ref. No.
> Better Buried Closure BB2X12-8882/HIGHGEL, size: 2 x 12 inch	80-6111-4782-0
> Better Buried Closure BB2X24-8882/HIGHGEL, size: 2 x 24 inch	80-6111-4783-8
> Better Buried Closure BB3X24-8882/HIGHGEL, size: 3 x 24 inch	80-6111-4784-6
> Better Buried Closure BB4X24-8882/HIGHGEL, size: 4 x 24 inch	80-6111-4785-3
> Better Buried Closure BB5X26-8882/HIGHGEL, size: 5 x 26 inch	80-6111-4786-1

2.2 Splice Protection Products

Technical Specifications

Partial Kits for Gravity Pour Encapsulation Method

3M Better Buried Closures are rigid body splice closures designed for direct burial. When filled with 3M 8882 Reenterable Encapsulating Compound, the closure can be reentered for splice re-work.

It is suggested to use 3M Scotchlok Connectors and 3M MS² modules along with the Better Buried closures. It is required to use DR tape 68631 and B sealing tapes, not manufactured by 3M.

Encapsulated: Yes
Re-enterable: Yes

Kit Contents:

3M Better Buried Sleeve Kits (Closure Extension), Hose clamps, 3M Scotchcast Spacer Web 4430 (for re-entry only), 3M Scotchcast Strain Relief Bar Kits 4465 or 4465-L, 3M Better Buried End Caps (bulk),

Funnel, Closure body, Sheath scuff material, Bonding braid, 3M Scotchcast Pair Saver 4458 or 4458W, 3M Scotchlok Shield Bond Connectors 4460-D

Features	BB3X12-SB/2DC-LHS	BB4X12-SB/2DC-LHS	BB7X26-SW/FC-PC	BB2X12-SB/2SC-LHS	BB2X24-SB/SC,DC-LHS	BB2X24-SB/2SC-LHS	BB3X24-SB/SC,DC-LHS	BB3X24-SB/2SC-LHS	BB4X24-SB/SC,DC-LHS
Encapsulation Method	Gravity Pour	Gravity Pour	Gravity Pour	Gravity Pour	Gravity Pour	Gravity Pour	Gravity Pour	Gravity Pour	Gravity Pour
Splice Bundle Diameter	3.0 inches	4.0 inches	7.0 inches	2.0 inches	2.0 inches	2.0 inches	3.0 inches	3.0 inches	4.0 inches
Maximum Splice Opening	7.0 inches	7.0 inches	19.0 inches	7.0 inches	17.0 inches	17.0 inches	17.0 inches	17.0 inches	17.0 inches
Closure Length End-to-End	16.0 inches	16.0 inches	30.0 inches	16.0 inches	28.0 inches	28.0 inches	28.0 inches	28.0 inches	30.0 inches
Maximum Pair Count (using 25-pair modular connectors)	100 pair	200 pair	1,200 pair	50 pair	100 pair	100 pair	200 pair	200 pair	400 pair
Maximum Pair Count (using 3M Scotchlok Connector UR2/UR)	75 pair	150 pair	600 pair	25 pair	50 pair	50 pair	100 pair	100 pair	200 pair
Approximate Compound Required ml (g*)	1,320 (1,200)	2,500 (2,250)	15,000 (16,500)	660 (600)	1,320 (1,200)	1,320 (1,200)	3,300 (3,000)	3,300 (3,000)	4,500 (5,000)
Packaging (each per box)	1	1	1	10	1	1	1	1	1
Minimum Order	1 each	1 each	1 each	10 each	1 each	1 each	1 each	1 each	1 each

Features	BB4X24-SB/2SC-LHS	BB5X26-SB/SC,DC-LHS	BB5X26-SB/2SC-LHS	BB6X26-SB/2DC-LHS	BB7X26-SB/DC,TC-LHS	BB7X26-SB/2DC-LHS	BB9X26-SB/DC,TC-LHS	BB9X26-SB/2DC-LHS	
Encapsulation Method	Gravity Pour	Gravity Pour	Gravity Pour	Gravity Pour	Gravity Pour	Gravity Pour	Gravity Pour	Gravity Pour	
Splice Bundle Diameter	4.0 inches	5.0 inches	5.0 inches	6.0 inches	7.0 inches	7.0 inches	9.0 inches	9.0 inches	
Maximum Splice Opening	17.0 inches	19.0 inches	19.0 inches	19.0 inches	19.0 inches	19.0 inches	19.0 inches	19.0 inches	
Closure Length End-to-End	30.0 inches	30.0 inches	30.0 inches	30.0 inches	30.0 inches	30.0 inches	30.0 inches	30.0 inches	
Maximum Pair Count (using 25-pair modular connectors)	400 pair	600 pair	600 pair	900 pair	1,200 pair	1,200 pair	2,400 pair	2,400 pair	
Maximum Pair Count (using 3M Scotchlok Connector UR2/UR)	200 pair	300 pair	300 pair	400 pair	600 pair	600 pair	900 pair	900 pair	
Approximate Compound Required ml (g*)	4,500 (5,000)	7,200 (8,300)	7,200 (8,300)	12,500 (13,750)	15,000 (16,500)	15,000 (16,500)	21,000 (23,100)	21,000 (23,100)	
Packaging (each per box)	1	1	1	1	1	1	1	1	
Minimum Order	1 each	1 each	1 each	1 each	1 each	1 each	1 each	1 each	

2.2 Splice Protection Products

Ordering Information

	Ref. No.
> Better Buried Closure BB3X12-SB/2DC-LHS , size: 3 x 12 inch, strain relief bond bar, 2 double port end caps, locking harness system	80-6108-6338-5
> Better Buried Closure BB4X12-SB/2DC-LHS , size: 3 x 12 inch, strain relief bond bar, 2 double port end caps, locking harness system	80-6109-3328-7
> Better Buried Closure BB7X26-SW/FC-PC , size: 7 x 26 inch, spaces web, 2 single port entry caps	80-6103-2784-5
> Better Buried Closure BB2X12-SB/2SC-LHS , size: 2 x 12 inch, strain relief bond bar, 2 single port end caps, locking harness system	80-6104-1204-3
> Better Buried Closure BB2X24-SB/SC,DC-LHS , size: 2 x 24 inch, strain relief bond bar, 1 single port end cap, 1 double port end cap, locking harness system	80-6104-1205-0
> Better Buried Closure BB2X24-SB/2SC-LHS , size: 2 x 24 inch, strain relief bond bar, 2 single port end caps, locking harness system	80-6104-1206-8
> Better Buried Closure BB3X24-SB/SC,DC-LHS , size: 3 x 24 inch, strain relief bond bar, 1 single port end cap, 1 double port end cap, locking harness system	80-6104-1211-8
> Better Buried Closure BB3X24-SB/2SC-LHS , size: 3 x 24 inch, strain relief bond bar, 2 single port end caps, locking harness system	80-6104-1212-6
> Better Buried Closure BB4X24-SB/SC,DC-LHS , size: 4 x 24 inch, strain relief bond bar, 1 single port end cap, 1 double port end cap, locking harness system	80-6104-1216-7
> Better Buried Closure BB4X24-SB/2SC-LHS , size: 4 x 24 inch, strain relief bond bar, 2 single port end caps, locking harness system	80-6104-1217-5
> Better Buried Closure BB5X26-SB/SC,DC-LHS , size: 5 x 26 inch, strain relief bond bar, 1 single port end cap, 1 double port end cap, locking harness system	80-6104-1221-7
> Better Buried Closure BB5X26-SB/2SC-LHS , size: 5 x 26 inch, strain relief bond bar, 2 single port end caps, locking harness system	80-6104-1222-5
> Better Buried Closure BB6X26-SB/2DC-LHS , size: 6 x 26 inch, strain relief bond bar, 2 double port end caps, locking harness system	80-6104-1624-2
> Better Buried Closure BB7X26-SB/DC,TC-LHS , size: 7 x 26 inch, strain relief bond bar, 1 double port end cap, 1 tripple port end cap, locking harness system	80-6104-1625-9
> Better Buried Closure BB7X26-SB/2DC-LHS , size: 7 x 26 inch, strain relief bond bar, 2 double port end caps, locking harness system	80-6104-1626-7
> Better Buried Closure BB9X26-SB/DC,TC-LHS , size: 9 x 26 inch, strain relief bond bar, 1 double port end cap, 1 tripple port end cap, locking harness system	80-6104-1627-5
> Better Buried Closure BB9X26-SB/2DC-LHS , size: 9 x 26 inch, strain relief bond bar, 2 double port end caps, locking harness system	80-6104-1628-3

2.2 Splice Protection Products

Technical Specifications

Partial Kits for Compound Compression Encapsulation Method

3M Better Buried Closures are rigid body splice closures designed for direct burial. When filled with 3M 8882 Re-enterable Encapsulating Compound, the closure can be re-entered for splice re-work.

Encapsulated: Yes
 Re-enterable: Yes
 Encapsulation Method: Compound Compression

Kit Contents:

3M Scotchlok Shield Bond Connector 4460-D, 3M Better Buried Sleeve Kits (Closure Extension), Hose clamps, 3M Scotchcast Spacer Web 4430 (for re-entry only), Protective Gloves (2-pair), Foam Collar Tape, Sheath scuff material, Foam Strips, Locking H Strips, 3M Scotchcast Strain Relief Bar Kits 4465 or 4465-L, Bonding braid, 3M Better Buried End Caps (bulk), Cleaning pad, Cable Ties, Funnel, Closure body

Features	BB2X24CC-SB/2SC-LHS	BB6X26CC-SB/2DC-LHS	BB3X24CC-SB/2SC-LHS	BB5X26CC-SB/2SC-LHS	BB7X26CC-SB/2DC-LHS	BB9X26CC-SB/2DC-LHS	BB4X24CC-SB/2SC-LHS
Splice Bundle Diameter	2.0 inches	6.0 inches	3.0 inches	5.0 inches	7.0 inches	9.0 inches	4.0 inches
Maximum Splice Opening	17.0 inches	19.0 inches	17.0 inches	19.0 inches	19.0 inches	19.0 inches	17.0 inches
Closure Length End-to-End	28.0 inches	30.0 inches	28.0 inches	30.0 inches	30.0 inches	30.0 inches	30.0 inches
Maximum Pair Count (using 25-pair modular connectors)	100 pair	900 pair	200 pair	600 pair	1,200 pair	2,400 pair	400 pair
Maximum Pair Count (using 3M Scotchlok Connector UR2/UR)	50 pair	400 pair	100 pair	300 pair	600 pair	900 pair	200 pair
Approximate Compound Required ml (g*)	1,320 (1,200)	12,500 (13,750)	3,300 (3,000)	7,200 (8,300)	15,000 (16,500)	21,000 (23,100)	4,500 (5,000)
Packaging (each per box)	1	1	1	1	1	1	1
Minimum Order	1 each	1 each	1 each	1 each	1 each	1 each	1 each

Ordering Information

	Ref. No.
> Better Buried Compound Compression Closure BB2X24CC-SB/2SC-LHS , size: 2 x 24 inch, strain relief bond bar, 2 single port end caps, locking harness system	80-6107-6468-2
> Better Buried Compound Compression Closure BB6X26CC-SB/2DC-LHS , size: 6 x 26 inch, strain relief bond bar, 2 double port end caps, locking harness system	80-6107-6470-8
> Better Buried Compound Compression Closure BB3X24CC-SB/2SC-LHS , size: 3 x 24 inch, strain relief bond bar, 2 single port end caps, locking harness system	80-6108-4544-0
> Better Buried Compound Compression Closure BB5X26CC-SB/2SC-LHS , size: 5 x 26 inch, strain relief bond bar, 2 single port end caps, locking harness system	80-6108-4545-7
> Better Buried Compound Compression Closure BB7X26CC-SB/2DC-LHS , size: 7 x 26 inch, strain relief bond bar, 2 double port end caps, locking harness system	80-6108-4546-5
> Better Buried Compound Compression Closure BB9X26CC-SB/2DC-LHS , size: 9 x 26 inch, strain relief bond bar, 2 double port end caps, locking harness system	80-6108-4547-3
> Better Buried Compound Compression Closure BB4X24CC-SB/2SC-LHS , size: 4 x 24 inch, strain relief bond bar, 2 single port end caps, locking harness system	80-6107-6469-0

2.2 Splice Protection Products

Accessories

3M Better Buried Closure

Description	Packaging	Min. Order	Ref. No.
Spacer web 6x20	1 roll per box	1 roll	4430-6X20
3M Better Buried Closures are rigid body splice closures designed for direct burial. When filled with 3M 8882 Re-enterable Encapsulating Compound, the closure can be re-entered for splice re-work	1 each per box	1 each	80-6104-1591-3
Better Buried Accessory	1 each per box	1 each	80-6104-1592-1
3M Better Buried Closures are rigid body splice closures designed for direct burial. When filled with 3M 8882 Re-enterable Encapsulating Compound, the closure can be re-entered for splice re-work. This kit has a 4" flat cap for butt configurations	1 each per box	1 each	80-6104-1593-9
E-Z Wrap is a tough, thin elastic vinyl material which sticks to itself when wrapped in layers. It forms a compact, durable, flexible, moisture-proof covering	12 each per box	12 each	80-6107-5955-9

3M Better Buried Closure Spare Parts

Description	Packaging	Min. Order	Ref. No.
Split sleeve for Better Buried Closures, 2 double sleeves, 24 inch	10 each per box	10 each	80-6100-7121-1
Split sleeve, double sleeve for Better Buried Closures, 3 x 24 inch	10 each per box	10 each	80-6100-7124-5
Split sleeve, double sleeve for Better Buried Closures, 4 x 24 inch	10 each per box	10 each	80-6100-7127-8
Split sleeve, double sleeve for Better Buried Closures, 5 x 26 inch	10 each per box	10 each	80-6100-8352-1

2.2 Splice Protection Products

Description - Closures



3M K&B Vault Closures

K&B Closures are strong, lightweight, and protect a wide variety of vault splice configurations with an air and water tight seal. K&B closures offer a full product line that is simple to install and re-enter. This full product offering provides closures in standard kits to protect the majority of cable configurations and customised and special closures to meet your vault requirements. All K&B closures are flame retardant. RUS Listed

Ordering 3M K&B Vault Closures

The key to ordering the correct K&B Vault Closures Kit is knowing what components suit the splice configuration. The kit can be a solid or split closure and have a collared end cap, multiple end cap, stainless steel hose clamps and cable lubricant.

Because the K&B vault closure is air and water tight, the closures collared and multiple end caps have to be sized precisely to the cables entering them. When ordering K&B closures, three pertinent facts are needed:

Technical Specifications

Chart A / Standard 3M K&B Closure Selection Guide

Maximum Pair Count		Solid Sleeve		Split Sleeve	
MS2*	Scotchlok	Kit Part Number	Diameter Length	Kit Part Number	Diameter Length
100	50	KB2-100-2	2-24		
200	100	KB3-175-1	3-24	KBS3-175-1	3DS-24
400	200	KB4-175-1 KB4-175-2	4-24 4-24		
600	300	KB5-100-6 KB5-130-6 KB5-175-2	5-26 5-26 5-26	KBS5-100-6 KBS5-130-6 KBS5-175-2	5DS-26 5DS-26 5DS-26
900	400	KB6-100-9 KB6-130-9 KB6-175-3	6-26 6-26 6-26	KBS6-100-9 KBS6-130-9 KBS6-175-3	6DS-26 6DS-26 6DS-26
1200	600	KB7-100-15 KB7-175-5	7-26 7-26	KBS7-100-15 KBS7-175-5	7DS-26 7DS-26
2400	800	KB8-100-24 KB8-130-18 KB8-175-8	8-26 8-26 8-26	KBS8-100-24 KBS8-130-18 KBS8-175-8	8DS-26 8DS-26 8DS-26
2700	900	KB9-100-27 KB9-130-24 KB9-175-9	9-26 9-26 9-26	KBS9-100-27 KBS9-130-24 KBS9-175-9	9DS-26 9DS-26 9DS-26
3600	–	KB10-100-36 KB10-100-36L	10-26 10-26	KBS10-100-36 KBS10-100-36L	10DS-26 10DS-24
4800	–	KB12-130-37	12-28		

* Based on 2-bank In-line splice using 4000D/TR modules

2.2 Splice Protection Products

Technical Specifications

- The diameter of all the cables, field and tip, to be spliced. This is needed for hole sizing of the end caps.
- The maximum number of cable pairs to be spliced and the type of connector to be used for splicing, an example is a 2700-pair field cable, spliced to 27-100 pair tip cable is a "2700-pair splice." This determines the size/diameter of the closure.
- The number of tip cables to be enclosed.

NOTE:

If the application determines that the closure does not need to be air and water tight, then the use of a K&B riser closure should be considered.

The standard K&B Vault Closure Kit contains the following:

- One closure, solid or split
- One collared end cap
- One multiple end cap
- Hose Clamps:

Solid closure - two closure clamps, one collared clamp

Split closure - three closure clamps, one collared clamp

Steps to Ordering Standard 3M K&B Closures Kits

1. Determine the maximum number of cable pairs, entering into the closure. If a 1200-pair field cable enters the closure, but is only spliced to 6-100 pair tip cables, this is still sized at the 1200 potential pairs.
2. Determine the type of module or connector to be used for splicing. The 25-pair module/connector is recommended because this can make for a more compact splice bundle for a smaller closure diameter.
3. Use "Chart A" to make a selection from the standard kits available. With the standard kits, the Collared Cap opening can be up to 6,35 mm (1/4") larger than the cable diameters. The clamp will tighten it down, and the multiple cap needs to be within the stated diameter range.
4. Fill any vacant multiple holes with the appropriate plug.

Vault Closures - Solid Sleeve (New Construction)

Some of the key suggested accessories for the K&B series include:

Bushings, Plugs, Scotchlok Connectors, Crimpers, 710 connectors/MS² connectors and splicing rigs.

Location of Use:

Vault

Kit Contents:

One solid sleeve, one collared end cap, one multiple end cap, two sleeve clamps, and one collared clamp.

Connector Type: Scotchlok/Modular

Maximum Number of Cable Pairs for Scotchlok	Maximum Number of Cable Pairs for Modular	Closure Diameter	Closure Length	Ref. No.
50	100	2.0 inches	24.0 inches	KB2-100-2
100	200	3.0 inches	24.0 inches	KB3-175-1
200	400	4.0 inches	24.0 inches	KB4-175-1
200	400	4.0 inches	24.0 inches	KB4-175-2
300	60	5.0 inches	26.0 inches	KB5-100-6
400	900	6.0 inches	26.0 inches	KB6-100-9
400	1200	7.0 inches	26.0 inches	KB7-100-15
400	2400	8.0 inches	26.0 inches	KB8-100-24
400	2400	8.0 inches	26.0 inches	KB8-130-18
400	2700	9.0 inches	26.0 inches	KB9-175-9

2.2 Splice Protection Products

Vault Closures - Split Sleeve (Existing Splice)

Some of the key suggested accessories for the K&B series include:
Bushings, Plugs, Scotchlok Connectors, Crimpers, 710 connectors/MS² connectors and splicing rigs.

Location of Use:
Vault

Kit Contents:

One solid sleeve, one collared end cap, one multiple end cap, two sleeve clamps, and one collared clamp.

Connector Type: Scotchlok/Modular

Maximum Number of Cable Pairs for Scotchlok	Maximum Number of Cable Pairs for Modular	Closure Diameter	Closure Length	Ref. No.
100	200	3.0 inches	24.0 inches	KBS3-175-1
300	600	5.0 inches	26.0 inches	KBS5-100-6
300	600	5.0 inches	26.0 inches	KBS5-130-6
400	900	6.0 inches	26.0 inches	KBS6-100-9
400	900	6.0 inches	26.0 inches	KBS6-130-9
400	900	6.0 inches	26.0 inches	KBS6-175-3
600	1200	7.0 inches	26.0 inches	KBS7-100-15
800	2400	8.0 inches	26.0 inches	KBS8-100-24
800	2400	8.0 inches	26.0 inches	KBS8-130-18
800	2400	8.0 inches	26.0 inches	KBS8-175-8
900	2700	9.0 inches	26.0 inches	KBS9-100-27
900	2700	9.0 inches	26.0 inches	KBS9-130-24
NA	3600	10.0 inches	26.0 inches	KBS10-100-36

Ref. No	Plugs						Caps	Bushings				
	PC-175	PC-298	PT-100	PT-125	PT-130	PT-175	C6-100-10	B-175-125	B-275-200	B-275-250	B-300-275	B-1.0-.25
KB2-100-2												•
KB3-175-1	•							•				
KB4-175-1	•							•				
KB4-175-2	•							•				
KB5-100-6									•	•		•
KB5-130-6				•	•	•						
KB6-100-9			•				•		•	•		•
KB6-130-9				•	•	•						
KB7-100-15			•						•	•		•
KB8-100-24		•	•								•	•
KB8-130-18		•		•	•	•					•	
KB8-175-8		•										
KB9-100-27		•	•									
KB9-130-24		•		•	•	•						
KB9-175-9								•			•	
KBS3-175-1								•				

2.2 Splice Protection Products

Ref. No	Plugs						Caps	Bushings				
	PC-175	PC-298	PT-100	PT-125	PT-130	PT-175	G6-100-10	B-175-125	B-275-200	B-275-250	B-300-275	B-1.0-.25
KBS5-100-6									•	•		•
KBS5-130-6									•	•		
KBS6-100-9									•	•		•
KBS6-130-9									•	•		
KBS6-175-3								•	•	•		
KBS7-100-15									•	•		•
KBS8-100-24											•	•
KBS8-130-18											•	
KBS8-175-8								•			•	
KBS9-100-27											•	
KBS9-130-24											•	
KBS10-100-36												•

Technical Specifications

3M K&B Plugs

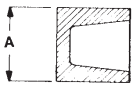
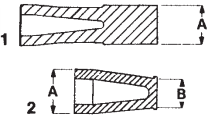
Rubber Bushes	Dimensional Diagram	Part Number	Dimension A	Dimension B
		Collared PC-175 PC-298	1.75 (44) 2.98 (76)	
		Tapered PT-100 PT-125 PT-130 PT-175	1.0 (25) 1.25 (32) 1.3 (33) 1.75 (44)	0.75 (19) 1.25 (32)

Ordering Information

Vault Closure Plugs

Product Name	Ref. No.
> Vault Closure Plug, collared, 1.75x1.75 in	PC-175
> Vault Closure Plug, collared, 2.98x2.98 in	PC-298
> Vault Closure Plug, tapered 1.0x1.0 in	PT-100
> Vault Closure Plug, tapered 1.25x0.75 in	PT-125
> Vault Closure Plug, tapered 1.3x1.3 in	PT-130
> Vault Closure Plug, tapered 1.75x1.25 in	PT-175

2.2 Splice Protection Products

Description - Closures

3M K&B Vault and Riser Closures

Steps to Ordering a Customised 3M K&B Closure

If it is determined that a "standard" kit does not fit your cable precisely, a "customised" closure might be used for an air and water tight fit.

1. To customise a closure, use steps 1 through 4 on p. 129 to determine the approximate closure size for your cable's pair count, splice connections and number of tip cables.
2. Once the approximate closure size is determined, then you make it a precisely fit closure by sizing to the cables using K&B Bushes from "Chart B."

As an example:

- You have a 1200-pair splice, with a 1200 pair field cable that has 50,8 mm (2.0") OD and 12-100 pair tip that has 25,4 mm (1.0") OD.



- The approximate closure size is a KB7-100-15. It has a multiple end cap with 15 openings of 25,4 mm (1.0") OD and a collared end cap with an opening of 69,9 mm (2.75") OD.
- The multiple end cap will give the tip cable a precise fit.
- The collared end cap is too big and needs a B275-200 bush to reduce the opening.

The order should be:

- One each KB7-100-15
- One each B-275-200-IC (this bush fits into the 69,9 mm (2.75") hole and reduces it down to 50,8 mm (2.0"). The "IC" stands for Insert and Cement)
- Three each PT100

Technical Specifications

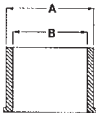
3M K&B Plugs

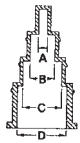
Rubber Bushes	Dimensional Diagram	Part Number	Dimension A	Dimension B	Dimension C	Dimension D
		B-175-125 B-275-200 B-275-250 B-300-275	1,75 (44) 2.0 (51) 2.5 (64) 2.75 (70)	1,25 (32) 2.0 (51) 2.5 (64) 2.75 (70)		
Variable Bushes						
		B-1.00-0.25 B-2.50-1.00	0.49 (12,4) 1.0 (25,4)	0.69 (17,5) 1.40 (35,6)	0.79 (20,1) 1.90 (48,3)	1.0 (25,4) 2.50 (63,5)

NOTE: inches (mm) *If inside diameter is less than 6,35 mm (0.25"), use KBS-1 to seal.

2.2 Splice Protection Products

Description - Closures

3M K&B Vault and Riser Closures

Steps to Ordering a Special 3M K&B Closure

If it is determined that a “standard” or “customised” closure kit will not fit your cable needs, a “special” closure might be used for your air and water tight closure applications. The “special” closure consists of factory built specialty parts, i.e., multiple field cable Collared Caps, split Collared Caps, specific multiple cable Multiple Caps, closure Split Sleeves that are not in a kit form. These “special” closure parts need to be ordered separately and may have to be factory built.

1. For a special closure, use steps 1 through 4 on p. 129 to determine the approximate size of your closure to your cable’s pair count, splice connections and number of tip cables. Once the approximate closure size is determined, make it a precise fit by piecing together the closure from “Chart C.”
2. The K&B Flat End Caps and Bushes are used in the factory to make the closure fit your requirements. Use the cable O.D. measurements to

specify the proper bushes from “Chart B” and the number of holes to be factory drilled. The “special” end caps will be shipped with holes drilled in the flat cap and bushes inserted and cemented.

3. When the “special” closure is used to cover an existing splice, the field cable collared end cap holes may need to be split so it can be installed. Multiple end caps cannot be split, a split Puddle Cap should be used. (See “Chart C” for the product number.) To seal the split of the end cap, use a KB-S1 Kit.
4. Both split and solid sleeves can also be factory cut to any length. See “Chart C” for the product number.
5. Order two closure clamps for a solid closure or three closure clamps for a split closure.
6. Order one collared clamp for each collared end opening or two collared clamps for a each split collared end opening.

Ordering Information

Vault Closure Bushings

Product Name	Ref. No.
> 3M Bushing B-175-125	B-175-125
> 3M Bushing B-275-200	B-275-200
> 3M Bushing B-275-250	B-275-250
> 3M Bushing B-300-275	B-300-275
> 3M B-1.0-.25 Variable Bushing B-1.0-.25	B-1.0-.25
> 3M B-2.5-1.0 Variable Bushing B-2.5-1.0, compatible with Bushing B-275-250	B-2.5-1.0

Vault Closure Flat Caps

Product Name	Ref. No.
> 3M Multiple End Cap C6-100-10	C6-100-10

2.2 Splice Protection Products

Accessories

Vault Closure

3M Fire Barrier Vault Kit 5925 was developed for use in conjunction with an existing vertically installed K&B vault closure when specific flame retardancy requirements such as the Bell System Technical Reference PUB 55006 (Issue 1, Section 5.53) are required. Kit contents include 3M Fire Barrier Foil Mat

298 mm x 3.7 m (11 3/4" x 12') and 3M Glass Cloth Tape 69 25 mm x 23 m (1" x 25 yds). Compatible with all K&B vault closures.

3M 2"-6" Closure Bonding Harness BH2-6 is meant for use in closure to ground shields of spliced cable; 14 AWG. Compatible with K&B vault closures 2-6.

Product Name	Ref. No.
> 3M Fire Barrier Vault Kit 5925	5925
> 3M Cable Lubricant 4 OZ Bottle Spare-NA/CL	SPARE-NA/CL
> 3M Splice Supports RC-100	RC-100
> 3M 2"-6" Closure Bonding Harness BH2-6	BH2-6

2.2 Splice Protection Products

Description - Closures



R-6 10 Port/Single Entry Closure



R3, R5, R7 and R9 Closures

3M K&B Building Riser Closure

The K&B Riser Closure has the same proven qualities of the K&B Vault Closure but are used in applications that do not require an air or water tight closure. Because of this, the end caps do not need to precisely fit the cable and are more versatile and user friendly. Use “Closure Selection Guide” for determining the proper closure size for your application. All K&B Riser Closures are flame retardant.

NOTE:

Single port SRC end caps are optional and must be ordered separately.

Kit contents:

- Split Closure Cover
- Stainless steel hose clamps (2)
- Flex strips (4)

- End caps (2)

- R3 and R5 – 2 each of double (2) entry conical end caps

- R6-10 – 1 each of a single (1) entry conical end cap and 1 each of a ten (10) port rubber end cap. Also 1 each of a 4 ounce bottle of cable lubricant.

- R7 and R9 – 2 each of triple (3) entry conical end caps

Closure Selection Guide

Product Number	R-3	R-5	R-6	R-7	R-9
Closure inside dimensions					
Diameter, mm (in.)	76 (3)	127 (5)	152 (6)	178 (7)	228 (9)
Length, mm (in.)	24 (607)	660 (26)	660 (26)	660 (26)	660 (26)
Approx. splice bundle capacity (Super-Mini)	300-pr. 24 AWG or less*	900-pr. 24 AWG*	900-pr. 24 AWG*	1800-pr. 24 AWG*	3000-pr. 26 AWG*

Maximum allowable cable diameter					
Multiple entry end caps					
Port 1, mm (in.)	30 (1.2)	51 (2.0)	84 (3.3)	79 (3.1)	96 (3.8)
Port 2, mm (in.)	30 (1.2)	51 (2.0)	Ports 1-10	61 (2.4)	79 (3.1)
Port 3, mm (in.)	–	–	28 (1.1)	51 (2.0)	61 (2.4)
Optional single entry end caps, mm (in.)	SRC-3 43 (1.7)	SRC-5 61 (2.4)	–	SRC-7 91 (3.6)	SRC-9 96 (3.8)

* Based on 2-Bank Straight Splice using 4000-D/TR Modules.

2.2 Splice Protection Products

Ordering Information

Riser Closures

Some of the key suggested accessories for the K&B series include: Scotchlok Connectors, Crimpers, 710 connectors/MS² connectors and splicing rigs.

Location of Use: Riser

Kit Contents:

Split closure cover, two stainless steel hose clamps, four flex strips, and two end caps.

Closure Diameter	Closure Length	Ref. No.
3.0 inches	24.0 inches	R-3
5.0 inches	26.0 inches	R-5
7.0 inches	26.0 inches	R-7
9.0 inches	26.0 inches	R-9
6.0 inches	26.0 inches	R-6

Accessories - Riser Closure Endcaps

Description	Cap Dimension	Compatible With	Ref. No.
Riser closure end cap.	9.0 inches	R-9	SRC-9
Riser closure end cap.	3.0 inches	R-3	SRC-3
Riser closure end cap.	5.0 inches	R-5	SRC-5

2.2 Splice Protection Products

Description - 3M™ Scotchcast™ Closures 8980 Series



3M Scotchcast Closures 8980 Series use a gravity fill method of encapsulating and protecting copper cables in either an underground or direct buried environment. Six rigid body closure sizes are offered to meet various cable diameters and splicing

capacities for the outside plant environment. Kits are packed with either 3M High Gel Re-enterable Encapsulant 8882 for easy re-entry or 3M Scotchcast Splice Encapsulating Compound 4407 for permanent protection.

Kit Contents



3M Scotchcast Closure 8981 Kit Contents	In 4407 Kit	In 8882 Kit
1 Left and right closure halves	•	•
1 3M Scotchlok Service Wire Shield Connector 4464		•
2 Pour spouts	•	•
3 Strips of Scotch® Rubber Splicing Tape 23	•	•
2 3M Scotchlok Shield Bond Connectors 4460-D		•
1 Spacer web	•	•
2 Cable ties		•

3M Scotchcast Closure 8982 & 8983 Kit Contents	In 4407 Kit	In 8882 Kit
1 Left and right closure halves	•	•
1 Bonding strap 6.5" (165 mm)		•
1 Spacer tube		•
2 Pour spouts	•	•
1 Spacer web	•	•
1 DR Tape		•
1 Scotch® All Weather Telephone Vinyl Plastic Tape 88T		•
1 B Sealing Tape Strips		•
2 4460-D shield bond connectors		•
1 Sheath scuff		•
2 Cable ties		•
3 Strips of Scotch® Rubber Splicing Tape 23	•	

2.2 Splice Protection Products

3M Scotchcast Closure 8984 Kit Contents	In 4407 Kit	In 8882 Kit
1 Upper and lower closure halves	•	•
1 Strain relief bar 11.5" (292 mm)		•
1 Spacer tube		•
1 Spacer web	•	•
1 DR Tape		•
1 Scotch® All Weather Telephone Vinyl Plastic Tape 88T		•
2 B Sealing Tape Strips		•
1 Sheath scuff		•
2 Cable ties		•
1 Cover	•	•
3 Strips of Scotch® Rubber Splicing Tape 23	•	
2 Fibreglass strip-bulk roll	•	

3M Scotchcast Closure 8985 & 8986 Kit Contents	In 4407 Kit	In 8882 Kit
1 Upper and lower closure halves	•	•
2 Strain relief bar 19.5" (495 mm)		•
2 Spacer tubes		•
1 DR Tape		•
1 88T vinyl tape		•
2 B sealant tape strips		•
4 3M Scotchlok Shield Connectors 4462-FN		•
1 Sheath scuff		•
1 Spacer web	•	•
2 Cable ties		•
3 #23 tape strips	•	
2 Fibreglass strip-bulk roll	•	
1 Cover	•	•

Accessories Required
Splicing connectors
Additional rubber tape, if needed
Additional B sealing tape, if needed

2.2 Splice Protection Products

Kit Contents

3M Scotchcast Closures 8980 Series with 3M High Gel Re-enterable Encapsulant 8882

Kit	Max. Pair Count	Max. Cable O.D.	Max. Splice O.D.	With High Gel Re-enterable Compound	Approx. Inside Closure Dia.
8981/High Gel*	4/24 [†]	0.625" (16 mm)	1.5" (38 mm)	(1) "A" Size Uni-pack 82 g (90 ml)	0.5" (13 mm)
8982/ High Gel*	18/24 [†]	1" (25 mm)	5.25" (133 mm)	(1) "E" Size Uni-pack 266 g (292 ml)	0.9" (22mm)
8983/High Gel	50/24 ^{***}	1.5" (38 mm)	9.75" (248 mm)	(1) "D" Size Uni-pack 600 g (659 ml)	1.25" (32 mm)
8984/High Gel	100/22 ^{***}	2" (51 mm)	9" (228 mm)	(2) "D" Size Uni-pack 1200 g (1318 ml)	2.25" (58 mm)
8985/High Gel	400/22 ^{***}	2.375" (60 mm)	17" (431 mm)	(5) "D" Size Uni-pack 2400 g (3295 ml)	3.5" (90 mm)
8986/High Gel	600/22 ^{***}	3.33" (86 mm)	17" (431 mm)	(10) "D" Size Uni-pack 6000 g (6590 ml)**	4.75" (120 mm)

* Intended for use on single cables only

** Additional compound may be required depending on cable size

*** Maximum pair count for the 3M MS² Splicing System

[†] Use only with 3M Scotchlok Butt Connectors

3M Scotchcast Closures 8980 Series with 3M Scotchcast Encapsulating Compound 4407

Kit	Max. Pair Count	Max. Cable O.D.	Max. Splice O.D.	With High Gel Re-enterable Compound	Approx. Inside Closure Dia.
8981-07*	4/24 [†]	0.625" (16 mm)	1.5" (38 mm)	(1) "A" Size Uni-pack 94 g (90 ml)	0.5" (13 mm)
8982-07*	18/24 [†]	1" (25 mm)	5.25" (133 mm)	(1) "E" Size Uni-pack 300 g (290 ml)	0.9" (22mm)
8983-07	50/24 ^{***}	1.5" (38 mm)	9.75" (248 mm)	(1) "D" Size Uni-pack 675 g (660 ml)	1.25" (32 mm)
8984-07	100/22 ^{***}	2" (51 mm)	9" (228 mm)	(2) "D" Size Uni-pack 1350 g (1320 ml)	2.25" (58 mm)
8985-07	400/22 ^{***}	2.375" (60 mm)	17" (431 mm)	(5) "D" Size Uni-pack 3375 g (2640 ml)	3.5" (90 mm)
8986-07	600/22 ^{***}	3.33" (86 mm)	17" (431 mm)	(10) "D" Size Uni-pack 6750 g (6600 ml)**	4.75" (120 mm)

* Intended for use on single cables only

** Additional compound may be required depending on cable size

*** Maximum pair count for the 3M MS² Splicing System

[†] Use only with 3M Scotchlok Butt Connectors

2.2 Splice Protection Products

Ordering Information

3M Scotchcast Closures 8980 Series with 3M High Gel Re-enterable Encapsulant 8882

Product Number	Min. Order	Ref. No.
> 8981-8882/HIGHGEL	10	80-6111-4775-4
> 8982-8882/HIGHGEL	10	80-6111-4776-2
> 8983-8882/HIGHGEL	10	80-6111-4777-0
> 8984-8882/HIGHGEL	1	80-6111-4778-8
> 8985-8882/HIGHGEL	1	80-6111-4779-6
> 8986-8882/HIGHGEL	1	80-6111-4780-4

3M Scotchcast Closures 8980 Series with 3M Scotchcast Encapsulating Compound 4407 Ordering Information

Product Number	Min. Order	Ref. No.
> 8981-07	10	80-6100-6704-5
> 8982-07	10	80-6100-6705-2
> 8983-07	10	80-6100-6706-0
> 8984-07	1	80-6101-0992-0
> 8985-07	1	80-6101-0990-4
> 8986-07	1	80-6100-6709-4

2.2 Splice Protection Products



Description - 3M™ Multi-Purpose Gel Cable Lubricant

3M Multi-Purpose Gel is a spreadable high performance silicone lubricant with microspheres that offer superior friction reduction recommended for use with most types of communication cables including copper and coaxial. Since the lubricant is a thick gel it can be hand applied or pumped into conduit. This gel is suitable for higher viscosity cable pulls and heavier cable jacket types.

Friction Testing

Friction is determined using standard Telcordia test procedure¹. The duct is wrapped 420° around a three-foot diameter. A 25-lb incoming weight is attached to the cable as it is pulled at a set rate of

65 feet per minute. A load cell takes pulling tension data which is used to determine a “dynamic” friction coefficient. Below is typical data.

Coefficient of Friction for MDPE Jacket Cable into HDPE Smoothwall Innerduct

Tension Incoming (lb)	Unlubricated	Lubricated with 3M MPG
25	>0.30	0.07

Features

- Compatible with most commonly used communication cable jackets
- Cleanly and evenly coats
- Non-staining/Non hazardous
- Slow drying for continuous lubricity
- Microspheres
- Thick gel doesn't drip and make a mess
- Temperature stable

Benefits

- One solution used for a variety of cable pulling jobs
- Provides consistent lubricity to provide superior friction reduction
- Safe to use/dispose
Easy to clean off
- Continue to pull cable even after lubricant has dried
Increase in productivity and cost-effective
- Lower coefficient of friction
- Increased productivity during and after pull
- Consistent friction reduction
- Doesn't get thin or runny

Application Use

Use for all types of cable installations, including:

- Silicone-lined and pre-lubricated ducts
- Heavierweight cable, building construction
- Vertical-up runs at beginning of pull
- Inside and outside environments

¹ Telcordia Standard TR-NWT-002811; Generic Requirements for Cable Placing Lubricants.

2.2 Splice Protection Products

Cable Lubricant Usage in Gallons

Quantity of 3M Multi-Purpose Gel Cable Lubricant in Gallons (Liters) Length of Pull Feet (Meters)

Conduit Size inches (CM)	500 (152)	1,000 (304)	2,000 (608)	3,000 (912)	4,000 (1,216)	5,000 (1,520)	6,000 (1,824)
1 (2.5)	0.75 (2.83)	1.5 (5.67)	3 (11.35)	4.5 (17.03)	6 (22.71)	7.5 (28.39)	9 (34.06)
2 (5.0)	1.5 (5.67)	3 (11.35)	6 (22.71)	9 (34.06)	12 (45.42)	15 (56.78)	18 (68.13)
3 (7.5)	2.25 (8.51)	4.5 (17.03)	9 (34.06)	13.5 (51.10)	18 (68.13)	22.5 (85.17)	27 (102.20)
4 (10)	3 (11.35)	6 (22.71)	12 (45.42)	18 (68.13)	24 (90.84)	30 (113.56)	36 (136.27)
5 (12.5)	3.75 (14.19)	7.5 (28.39)	15 (56.78)	22.5 (85.17)	30 (113.56)	37.5 (141.95)	45 (170.34)
6 (15)	4.5 (17.03)	9 (34.06)	18 (68.13)	27 (102.20)	36 (136.27)	45 (170.34)	54 (204.41)

Formula: $.0015 \times L \times D$

L= length in feet

D= diameter of conduit in inches

Formulation calculates how many gallons of lubricant are necessary to provide a 10 mil coating over the entire length of conduit

Cable Compatibility & Performance

Polyethylene Stress Cracking:

3M Multi-Purpose Gel Lube does not cause environmental stress cracking of polyethylene jackets commonly found on communications cables. Untreated polyethylene (Union Carbide DYNK) and MDPE jacket material were both tested according to ASTM standard method.¹ After 168 hours exposure none of the test specimens showed failures

Polycarbonate Stress Cracking:

3M Multi-Purpose Gel Lube will not stress crack polycarbonate. Polycarbonate bars are bent to a defined strain and exposed to lubricant as described in the Telcordia standard², Section 8.2, Stress Cracking of Polycarbonate. After 48 hours, none of the test specimens showed signs of cracking

Coatability:

Coatability is a measure of the lubricants' ability to coat the cable jacket as a thin film for continued lubricity during longer pulls. 3M Multi-Purpose Gel Cable Lubricant will coat evenly on the cable jacket surfaces. Lubricant will not bead up or rub off of jacket sample. A 1/2 –inch (13 mm) diameter MDPE fiber cable dipped six inches (152 mm) into the Multi-Purpose Gel lube, when withdrawn and held vertically will retain a minimum of 10 grams of Multi-Purpose Gel lubricant for one minute at 70° F (21°C).

Cling Factor:

Cling factor is a measure of the ability to apply the lubricant and have it stay on the jacket while the cable enters the duct. A six-inch length (152 mm) of a 1/2 –inch (13 mm) diameter cable will hold at least 25 grams of Multi-Purpose Gel for one minute when held vertically at 70° F (21°C).

Combustibility:

Lubricant has no flash point and dried residue is non-flammable.

¹ ASTM Test Method D1693, Environmental Stress-Cracking of Ethylene Plastics.

² Telcordia Standard TR-NWT-002811; Generic Requirements for Cable Placing Lubricants.

2.2 Splice Protection Products

Physical Properties

	Property	Result
Application Properties:	Appearance:	Opaque-white, stringy liquid
	Percent Non-Volatile Solids:	5 %
Temperature Use Range: 20°F to 120°F (-5°C to 50°C)	VOC Content:	0 gms/liter
	Viscosity:	40,000 – 70,000 cps @10rpm
	pH:	6.5 – 7.5



In addition to 3M Multi-Purpose Gel Cable Lubricant, 3M also makes 3M Concentrated Multi-Purpose Cable Lubricant and 3M Multi-Purpose Liquid Cable Lubricant, available in many sizes to fit your needs.

Temperature Stability

No phase-out after five freeze/thaw cycles or five-day exposure at 120°F (50°C).

Will not phase out or separate during the shelf life of lubricant.

Clean-Up

Use water to clean up the area.

Storage and Shelf Life

Store product tightly sealed and away from direct sunlight. Lubricant shelf life is one year past the date of manufacture.

Directions for Use

3M Multi-Purpose Gel Cable Lubricant can be squeezed or hand applied directly to the cable. Directly lubricate the cable during the entire portion of the pull as it enters the conduit.

For clean-up, use a cloth to wipe off excess lubricant from the end of the cable. The remaining residue will evaporate quickly.

Ordering Information

Product Number	Description	MOQ	Ref. No.
> 8981-07	Multi-Purpose Gel Quart Squeeze Bottle	12	80-6113-3175-4
> 8982-07	Multi-Purpose Gel One Gallon Pail (3.78 Liter)	4	80-6113-3174-7
> 8983-07	Multi-Purpose Gel Five Gallon Pail (18.9 Liter)	1	80-6113-3176-2

2.2 Splice Protection Products



Description - 3M™ Multi-Purpose Liquid Cable Lubricant

3M Multi-Purpose Liquid is a high performance silicone enhanced lubricant that offers superior friction reduction recommended for use with most types of communication cable including copper, fibre optic and coaxial. Pourable formula is especially suitable for longer cable pulls. This lubricant is suitable for low viscosity cable pulls in the outside environment.

Friction Testing

Friction is determined using standard Telcordia test procedure¹. The duct is wrapped 420° around a three-foot diameter. A 25-lb incoming weight is attached to the cable as it is pulled at a set rate of

65 feet per minute. A load cell takes pulling tension data which is used to determine a “dynamic” friction coefficient. Below is typical data.

Coefficient of Friction for MDPE Jacket Cable into HDPE Smoothwall Innerduct

Tension Incoming (lb)	Unlubricated	Lubricated with 3M MPL
25	>0.30	0.07

Features

- Compatible with most commonly used communication cable jackets
- Non-staining/Non hazardous
- Slow drying for continuous lubricity
- High cling
- Temperature stable
- Silicone enhanced for superior friction reduction

Benefits

- One solution used for a variety of cable pulling jobs
- Safe to use/dispose
Easy to clean off
- Reduces the need to re-lubricate the cable during a pull
Increase in productivity and cost-effective
- Stays on the cable and completely covers it
Decreases friction
- Consistent results for each job
- Low probability for damaged cables during pull

Application Use

Use for all types of cable installations, including:

- Ideal for longer cable pulls
- Silicone-lined and pre-lubricated ducts
- Lightweight cable, building construction
- Suitable for fiber optic, copper and coaxial communication cable
- Outside environment

¹ Telcordia Standard TR-NWT-002811; Generic Requirements for Cable Placing Lubricants.

2.2 Splice Protection Products

Cable Lubricant Usage in Gallons

Quantity of 3M Multi-Purpose Liquid Cable Lubricant in Gallons (Liters) Length of Pull Feet (Meters)

Conduit Size inches (CM)	500 (152)	1,000 (304)	2,000 (608)	3,000 (912)	4,000 (1,216)	5,000 (1,520)	6,000 (1,824)
1 (2.5)	0.75 (2.83)	1.5 (5.67)	3 (11.35)	4.5 (17.03)	6 (22.71)	7.5 (28.39)	9 (34.06)
2 (5.0)	1.5 (5.67)	3 (11.35)	6 (22.71)	9 (34.06)	12 (45.42)	15 (56.78)	18 (68.13)
3 (7.5)	2.25 (8.51)	4.5 (17.03)	9 (34.06)	13.5 (51.10)	18 (68.13)	22.5 (85.17)	27 (102.20)
4 (10)	3 (11.35)	6 (22.71)	12 (45.42)	18 (68.13)	24 (90.84)	30 (113.56)	36 (136.27)
5 (12.5)	3.75 (14.19)	7.5 (28.39)	15 (56.78)	22.5 (85.17)	30 (113.56)	37.5 (141.95)	45 (170.34)
6 (15)	4.5 (17.03)	9 (34.06)	18 (68.13)	27 (102.20)	36 (136.27)	45 (170.34)	54 (204.41)

Formula: $.0015 \cdot L \cdot D$

L= length in feet

D= diameter of conduit in inches

Formulation calculates how many gallons of lubricant are necessary to provide a 10 mil coating over the entire length of conduit

Cable Compatibility & Performance

Polyethylene Stress Cracking:

3M Multi-Purpose Gel Lube does not cause environmental stress cracking of polyethylene jackets commonly found on communications cables. Untreated polyethylene (Union Carbide DYNK) and MDPE jacket material were both tested according to ASTM standard method.¹ After 168 hours exposure none of the test specimens showed failures.

Polycarbonate Stress Cracking:

3M Multi-Purpose Gel Lube will not stress crack polycarbonate. Polycarbonate bars are bent to a defined strain and exposed to lubricant as described in the Telcordia standard², Section 8.2, Stress Cracking of Polycarbonate. After 48 hours, none of the test specimens showed signs of cracking.

Combustibility:

Lubricant has no flash point and dried residue is non-flammable.

¹ ASTM Test Method D1693, Environmental Stress-Cracking of Ethylene Plastics.

² Telcordia Standard TR-NWT-002811; Generic Requirements for Cable Placing Lubricants.

2.2 Splice Protection Products

Physical Properties

	Property	Result
Application Properties:	Appearance:	Opaque-white, stringy liquid
	Percent Non-Volatile Solids:	2 %
Temperature Use Range: 20°F to 120°F (-5°C to 50°C)	VOC Content:	0 gms/liter
	Viscosity:	1,000 – 3,000 cps @10rpm
	pH:	6.5 – 7.5



In addition to 3M Multi-Purpose Liquid Cable Lubricant, 3M also makes 3M Concentrated Multi-Purpose Cable Lubricant and 3M Multi-Purpose Gel Cable Lubricant, available in many sizes to fit your needs.

Temperature Stability

No phase-out after five freeze/thaw cycles or five-day exposure at 120°F (50°C).

Will not phase out or separate during the shelf life of lubricant.

Clean-Up

Use water to clean up the area.

Storage and Shelf Life

Store product tightly sealed and away from direct sunlight. Lubricant shelf life is one year past the date of manufacture.

Directions for Use

3M Multi-Purpose Gel Cable Lubricant can be squeezed or hand applied directly to the cable. Directly lubricate the cable during the entire portion of the pull as it enters the conduit.

For clean-up, use a cloth to wipe off excess lubricant from the end of the cable. The remaining residue will evaporate quickly.

Ordering Information

Product Number	Description	MOQ	Ref. No.
> CL-MPL-1	Multi-Purpose Cable Lubricant Liquid One Gallon Jug	4	80-6113-3179-6
> CL-MPL-5	Multi-Purpose Cable Lubricant Liquid Five Gallon Pail	1	80-6113-3180-4

2.2 Splice Protection Products

Description - 3M™ Concentrated Multi-Purpose Cable Lubricant



3M Concentrated Multi-Purpose Cable Lubricant is suitable for almost any communications cable pull job and is compatible with most commonly used communication jackets. Because this product is highly concentrated, it uses 1/4 as much lubricant than standard product and is designed to provide friction reduction that lasts even as the lubricant dries. Concentrated Multi-Purpose Cable Lubricant is available in three different packaging types: a spray, wipes and pourable liquid to ensure the most efficient application for pulling cable. Wipes and spray applications are effective in vertical cable pulls using lightweight cables. This lubricant issuitable for either the inside or outside environment.

Friction Testing

Friction is determined using standard Telcordia test procedure¹. The duct is wrapped 420° around a three-foot diameter. A 25-lb incoming weight is attached to the cable as it is pulled at a set rate of

65 feet per minute. A load cell takes pulling tension data which is used to determine a “dynamic” friction coefficient. Below is typical data.

Coefficient of Friction for MDPE Jacket Cable into HDPE Continuous Innerduct

Tension Incoming (lb)	Unlubricated	CMP Wipes	CMP Liquid	CMP Spray
25	0.30	0.08	0.07	0.07

Features

- Non-staining/Non hazardous
- Easy spray or wipe application
- Product is compatible with all commonly used communication jackets
- Slow drying for continuous lubricity
- Highly concentrated silicone lubricant
- Thin film lubricant

Benefits

- Safe to use/dispose
Easy to clean off
- Quick and easy to use with virtually no mess or excess
- Can be used on fiber, copper and coaxial cable jackets
One product handles most jobs
- Lower coefficient of friction even after lube has dried
Eases cable replacement
- Uses 1/4 as much lubricant
Superior friction reduction
- No dripping
Suitable for vertical pulls

Application Use

Use for all types of cable installations, including:

- Fibre optic cable drops
- Lightweight cable, building construction
- High performance data cables
- Vertical cable pulls
- Inside and outside environment
- Copper
- Coaxial

¹ Telcordia Standard TR-NWT-002811; Generic Requirements for Cable Placing Lubricants.

2.2 Splice Protection Products

Performance Properties

Coatability & Cling Factor:

3M Concentrated Multi-Purpose (CMP) Cable Lubricant will coat the cable jacket evenly to provide friction reduction. Since CMP is a highly concentrated thin film lubricant it is designed to continue providing friction reduction even after it dries.

Sprayability:

Low viscosity lubricant allows product to flow through spray head. Lubricant will not clog valves.

Combustibility:

Lubricant has no flash point and dried residue is non-flammable.

Cable Lubricant Usage in Gallons

Quantity of 3M Concentrated Multi-Purpose* Cable Lubricant in Gallons (Liters) Length of Pull Feet (Meters)

Conduit Size inches (CM)	500 (152)	1,000 (304)	2,000 (608)	3,000 (912)	4,000 (1,216)	5,000 (1,520)	6,000 (1,824)
1 (2.5)	0.19 (0.71)	0.38 (1.43)	0.75 (2.83)	1.13 (4.27)	1.5 (5.67)	1.88 (7.11)	2.25 (8.51)
2 (5.0)	0.38 (1.43)	0.75 (2.83)	1.5 (5.67)	2.25 (8.51)	3 (11.35)	3.75 (14.19)	4.5 (17.03)
3 (7.5)	0.56 (2.11)	1.13 (4.27)	2.25 (8.51)	3.38 (12.79)	4.5 (17.03)	5.63 (21.31)	6.75 (25.55)
4 (10)	0.75 (2.83)	1.5 (5.67)	3 (11.35)	4.5 (17.03)	6 (22.71)	7.5 (28.39)	9 (34.06)
5 (12.5)	0.94 (3.55)	1.88 (7.11)	3.75 (14.19)	5.63 (21.31)	7.5 (28.39)	9.38(35.50)	11.25 (42.58)
6 (15)	1.13 (4.27)	2.25 (8.51)	4.5 (17.03)	6.75 (25.55)	9 (34.06)	11.25 (42.58)	13.5 (51.10)

Formula: $.000375 * L * D$

L= length in feet

D= diameter of conduit in inches

*For use with one gallon Concentrated Multi-Purpose Cable Lubricant. Spray and wipes application is intended for shorter cable pulls (distance) than illustrated above.

Cable Compatibility

Polyethylene Stress Cracking:

3M Concentrated Multi-Purpose Cable Lubricant does not cause environmental stress cracking of polyethylene jackets commonly found on communications cables. Untreated polyethylene (Union Carbide DYNK) and MDPE jacket material were both tested according to ASTM standard method.¹ After 168 hours exposure none of the test specimens showed failures.

Section 8.2, Stress Cracking of Polycarbonate. After 48 hours, none of the test specimens showed signs of cracking.

Corrosion of Copper and Steel:

3M Concentrated Multi-Purpose Cable Lubricant will not corrode copper after 24 hour exposure as described in the Telcordia standard², Section 8.3, Copper Mirror Test.

Polycarbonate Stress Cracking:

3M Concentrated Multi-Purpose Cable Lubricant will not stress crack polycarbonate. Polycarbonate bars are bent to a defined strain and exposed to lubricant as described in the Telcordia standard²,

¹ ASTM Test Method D1693, Environmental Stress-Cracking of Ethylene Plastics.

² Telcordia Standard TR-NWT-002811; Generic Requirements for Cable Placing Lubricants.

2.2 Splice Protection Products

Physical Properties

	Property	Result
Application Properties:	Appearance:	Slightly thickened, white liquid
	Percent Non-Volatile Solids:	97 %
Temperature Use Range: 20°F to 120°F (-5°C to 50°C)	VOC Content:	0 gms/liter
	Viscosity:	250-750 cps @10rpm
	pH:	6.5 – 8.0



In addition to 3M Concentrated Multi-Purpose Cable Lubricant, 3M also makes 3M Multi-Purpose Gel Cable Lubricant and 3M Multi-Purpose Liquid Cable Lubricant, available in many sizes to fit your needs.

Temperature Stability

No phase-out after five freeze/thaw cycles or five-day exposure at 120°F (50°C).

Will not phase out or separate during the shelf life of lubricant.

Clean-Up

Use water to clean up the area.

Storage and Shelf Life

Store product tightly sealed and away from direct sunlight. Lubricant shelf life is one year past the date of manufacture.

Directions for Use

3M Concentrated Multi-Purpose Cable Lubricant Spray

Apply 5 to 10 sprays directly into conduit just before pulling or pushing. For larger conduit or longer pulls, spray additional lubricant onto the cable or into the conduit if the tension increases.

For 3M Concentrated Multi-Purpose Cable Lubricant Wipes

Wipe cable as it enters conduit or attach wipe to pulling line to pre-lubricate conduit. One towel is

sufficient for small cable and for installations or drops under 200 feet. Use additional lubricant wipes on longer pulls or when tension increases.

For 3M Concentrated Multi-Purpose Cable Lubricant Liquid

Can be poured directly onto the wire or cable. Directly lubricate the cable or wire during the entire portion of the pull as it enters the conduit.

Ordering Information

Product Number	Description	MOQ	Ref. No.
> CL-CMP-QTS	Concentrated Multi-Purpose Cable Lubricant Quart Spray Bottle	12	80-6113-3182-0
> CL-CMP-1	Concentrated Multi-Purpose Cable Lubricant 1 Gallon Jug	4	80-6113-3183-8
> CL-CMP-C	Concentrated Multi-Purpose Cable Lubricant 20-CT Wipe Canister	12	80-6113-3184-6

2.2 Splice Protection Products



Description

3M Scotchcast Encapsulating and Blocking Compound 4407

3M Scotchcast Encapsulating and Blocking Compound 4407 is a hard encapsulant designed specifically for permanent splice protection and cable blocking applications. Scotchcast 4407 compound is formulated for virtually every telecommunications application requiring a hard, non-reenterable compound with good handling and performance characteristics. Scotchcast 4407 compound is a two-part polyurethane compound. It features excellent

wetting properties and low viscosity, which means it flows quickly and freely. Its low temperature cure properties mean that it may be used in a wide range of temperatures. Scotchcast 4407 compound doesn't contain TDI and meets applicable OSHA standards for safety.

Location of Use: Closure, Blocking
Re-enterable: No

Ordering Information

Product	Pouch Size (ml)	Packaging	Minimum Order	Ref. No.
> 8882	1415	2 each per box	2 each	4407-1500/F
> 4407-A	89	10 each per box	10 each	4407-A
> 4407-B	197	10 each per box	10 each	4407-B
> 4407-C	396	10 each per box	10 each	4407-C
> 4407-D	636	10 each per box	10 each	4407-D
> 4407-E	283	10 each per box	10 each	4407-E

3M Scotchcast Duct Sealing Kit 4416



The 4416 duct sealing kit prevents water and other liquids from running out of a cable duct and entering a manhole or central office. RUS Listed. 4430-F is an additional accessory for the 4416. It is not required upon purchase.

Location of Use: Duct, Conduit
Re-enterable: No

Ordering Information

Product	Packaging	Minimum Order	Ref. No.
> 4430F	1 kit per box	1 kit	4430F
> 4416	1 each per box	1 each	4416

2.2 Splice Protection Products

3M Scotchcast Pedestal Base Sealant Kit 4411



3M Scotchcast Pedestal Base Sealant Kit 4411 is a two-part non-reenterable expanding sealant that cures to a hard, lightweight foam that is used to fill pedestal bases. Scotchcast 4411 sealant is designed to prevent ground moisture from entering

the pedestal as well as protecting against rodents and insects.

Location of Use: Cabinet, Pedestal
Re-enterable: No

Ordering Information

Product	Packaging	Minimum Order	Ref. No.
> 4411-B	16 bags per box	16 bags	4411-B
> 4411-D	16 bags per box	16 bags	4411-D
> 4411-A	16 bags per box	16 bags	4411-A

3M Scotchcast Plugging Under Pressure (PUP) Kit 4477



This easy-to-use kit is a system that allows the craftsman to make a pressure block without cable line air pressure shutdown. The kit saves time in making a pressure block because it contains all the necessary components in a system package. The 4477-R kit is a replenishment kit that permits use of 4477 kit components that are removed after plug curing for other pressure block applications. The PUP kit's relief valve and bypass tube automatically

equalize pressure to 5 p.s.i. on both sides of the injection point. The system's injection valve permits compound injection without loss or mess while the cross fitting permits the addition of an "F" valve for adding buffered air or monitoring. The 4477-R kit includes 60 plungers for SCS usage.

Location of Use: N/A
Re-enterable: No

Ordering Information

Product	Packaging	Minimum Order	Ref. No.
> 4477	1 kit per box	1 kit	4477
> 4477-R	1 kit per box	1 kit	4477-R

3M Scotchcast Single Cartridge System Kit 4407 Series



The Scotchcast cable blocking system features a reusable injection cartridge which can be used for as many as six injections of Scotchcast 4407 compound, or up to 72 oz. (2 kg) of compound, depending on the size of the block. The single cartridge system can be used on both open and

direct sheath applications, on vertical as well as horizontal blocks, and on plugs made under pressure. The cable blocking system comes with an injection gun.

Location of Use: Blocking
Re-enterable: No

Ordering Information

Product	Packaging	Minimum Order	Ref. No.
> 4407/SCS-D	10 each per box	10 each	4407/SCS-D
> 4407/SCS	1 kit per box	1 kit	4407/SCS

2.2 Splice Protection Products

Description - 3M™ High Gel Re-enterable Encapsulant 8882



3M High Gel Re-enterable Encapsulant 8882

3M High Gel Re-enterable Encapsulant 8882 is a two-part nonurethane encapsulating compound. The encapsulant aggressively adheres to filled cable and is compatible with common plastics used in telephone splice connectors.

The encapsulant permits easy cable splice re-entry for future changes and maintenance. The 8882 encapsulant is one of a system of products available from 3M.

Properties

Property	Test Method	Typical Value
Isocyanate Content	Non applicable	Not Isocyanate based
Tensile Strength	ASTM D412	11 psi at 75°F (126 kN/m ² at 24°C)
Elongation	ASTM D412 at 75°F (24°C)	300%
Tear Strength	ASTM D624 15 in./min.	1.6 lb./in. at 75°F (595 N/m at 24°C)
Coated Conductor Pull-out Flexgel	Telcordia TA-TSY-000354 Par. 6.15	9.2 lb. (77.8N)/pair 22 AWG (0.65 mm)
Filling Compound Compatibility -Flexgel	Telcordia TA-TSY-000354 Par 6.17	2.1% gain at 70°F (21°C) 4.0% gain at 150°F (66°C)
Polycarbonate Compatibility	TA-TSY-000354 Par. 6.7	No stress cracking or physical property changes observed in samples
Gel Time	3M test method (Sunshine Gel Meter)	100-110 min. at 40°F (4°C) 50-70 min. at 75°F (24°C) 30-40 min. at 110°F (43°C)''
Hydrolytic Stability	Telcordia TA-TSY-000354 Par. 6.01	3% gain
Peak Exotherm	Telcordia TA-TSY-000354 Par. 6.02	6°F rise from 75°F (3°C rise from 24°C)
Water Absorption	ASTM D570	<0.2% gain
Dry Heat Aging	Telcordia TA-TSY-000354 Par. 6.03	2.0% loss
Color		Amber, transparent
Odor		Essentially odorless
Shelf Life	Telcordia TA-TSY-000354 Par. 6.10	No changes in gel time and physical properties after 14 days at 140°F(60°C)
Volumetric Expansion	Telcordia TA-TSY-000354 Par. 6.05	0% observed

2.2 Splice Protection Products

Properties (continued)

Property	Test Method	Typical Value
Viscosity Part A & Part B Mixed	3M test method (Brookfield Viscometer)	670 cps at 75°F (24°C) (4 minutes) 2150 cps at 40°F (4°C) (4 minutes)
Water Sensitivity	Telcordia TA-TSY-00354 Par. 6.07	<1.0% observed
Bond to Materials	Telcordia TA-TSY-00354 Par. 6.12	Good adhesion
Phase Stability	Telcordia TA-TSY-00354 Par. 6.14	Clear with no striations
Compatibility with Trilene, 4442, Caschem 165	Telcordia TA-TSY-00354 Par. 6.09	Complete bonding, no observed adverse effects
Copper Corrosion	Western Electric MS 17000, Section 1139 TA-TSY-000354 Par. 5.2.1	Non-corrosive

Ordering Information

Product	Ref. No.
> 8882-1500/F High Gel Re-enterable Encapsulant (1,648 ml) in foil film bag	8882-1500/F
> 8882-1900C High Gel Re-enterable Encapsulant (1,979 ml) in foil film bag	8882-1900C
> 8882-3000/F High Gel Re-enterable Encapsulant (2 pcs. 1,648 g) foil bags) = (3,296 ml) with pouch and pail*	8882-3000/F
> 8882-3000C High Gel Re-enterable Encapsulant (3,123 ml) with pouch and pail*	8882-3000C
> 8882-4500C High Gel Re-enterable Encapsulant (4,683 ml) with pouch and pail*	8882-4500C
> 8882-5000C High Gel Re-enterable Encapsulant (5,208 ml) with pouch and pail*	8882-5000C
> 8882-500C High Gel Re-enterable Encapsulant (521 ml) in guard bag	8882-500C
> 8882-6000 High Gel Re-enterable Encapsulant (6,593 ml) with pouch and pail*	8882-6000
> 8882-750/F High Gel Re-enterable Encapsulant (824 ml) in foil film bag	8882-750/F
> 8882-750C High Gel Re-enterable Encapsulant (781 ml) in foil film bag	8882-750C
> 8882-8000C High Gel Re-enterable Encapsulant (8,333 ml) with pouch and pail*	8882-8000C
> 8882-A High Gel Re-enterable Encapsulant (90 ml) in guard bag	8882-A
> 8882-C High Gel Re-enterable Encapsulant (385 ml) in guard bag	8882-C
> 8882-D High Gel Re-enterable Encapsulant (659 ml) in guard bag	8882-D
> 8882-E High Gel Re-enterable Encapsulant (292 ml) in guard bag	8882-E

* Pouch & Pail packaging contains bucket, lid, stirrer and disposable gloves.

"RoHS Compliant 2005/95/EC" means that the product or part ("Product") does not contain any of the substances in excess of the maximum concentration values in EU Directive 2002/95/EC, as amended by Commission Decision 2005/618/EC, unless the substance is in an application that is exempt under EU RoHS. This information represents 3M's knowledge and belief, which may be based in whole or in part on information provided by third party suppliers to 3M.

2.2 Splice Protection Products



3M Open Sheath Blocking Closures 4530

This system provides full pressure blocking on air core cable (paper or pulp insulated cable that has not been treated with anti-wetting agents and PIC).

Compound filling of the cable block can be accomplished by pouring and injecting or, when cable is under air pressure, by injecting alone. 3M Scotchcast Encapsulating and Blocking Compound 4407 is used with the 4530 and 4530-L closure kits.

Scotchcast 4407 compound is a two-part polyurethane compound characterized by excellent wetting properties and low viscosity which is ideal for pressure blocking applications. The 4407 compound is sold separately from the closure kit to permit optimization of the amount of compound used.

Location of Use: Duct
Re-enterable: No

Ordering Information

Product	Packaging	Minimum Order	Ref. No.
> 4530-KIT	10 kits per box	10 kits	4530-KIT
> 4530L	1 kit per box	1 kit	4530L

3M Open Sheath Blocking Closures 4530, 4530-L Accessories

This system provides full pressure blocking on air core cable (paper or pulp insulated cable that has not been treated with anti-wetting agents and PIC).

Compound filling of the cable block can be accomplished by pouring and injecting or, when cable is under air pressure, by injecting alone.

3M Scotchcast Encapsulating and Blocking Compound 4407 is used with the 4530 and 4530-L

closure kits.

Scotchcast 4407 compound is a two-part polyurethane compound characterized by excellent wetting properties and low viscosity which is ideal for pressure blocking applications. The 4407 compound is sold separately from the closure kit to permit optimization of the amount of compound used.

Ordering Information

Product Name	Packaging	Minimum Order	Ref. No.
> 3M Injection Cartridge 4530-IC	100 each per box	100 each	4530-IC
> 3M Stackable Plunger 4530-SP	700 each per box	700 each	4530-SP

2.2 Splice Protection Products



Description - Identification Products and Reflective Tapes

3M Scotchlite Custom Decals

Decals are made to customer requirements from Scotchlite reflective material. 76 mm x 127 mm (3" x 5") size. Prices for special sizes and quantities available on request. Minimum order: 5,000 labels.

3M Scotchlite 5005 Reflective Lettering System

Black characters on a "safety orange" background conform to the American National Standards Institute (ANSI) Z53.1-1979. Convenient and easy to use, letters and numbers are self-spacing, with self-sticking adhesive. Highly visible characters stand out at wide angles and remain visible in wet weather.

Using the Scotchlite reflective system proven in millions of highway applications, the 5000 lettering systems offers long-term durability.

25,4 mm x 38,1 mm (1"x1-1/2"). Each kit contains 25 each A-Z, 0-9, blank and dash characters, packaged in a clear, 36-compartment box, including an application tool. RUS Listed

Ordering Information

3M Scotchlite 5005 Reflective Lettering System Kit

Product Description	Packaging kg & (lbs.)/cs.	Minimum Order	Ref. No.
> Scotchcast W-9 (orange and black)	1 kit/cs., 1,0 (2.4)	1 kit	5005 decal "kit"
> Replenishment decal "A"	1000/cs., 0,9 (2.0)	1000 each	5005 decal "A"
> Replenishment decal "B"	1000/cs., 0,9 (2.0)	1000 each	5005 decal "B"
> Replenishment decal "C"	1000/cs., 0,9 (2.0)	1000 each	5005 decal "C"
> Replenishment decal "D"	1000/cs., 0,9 (2.0)	1000 each	5005 decal "D"
> Replenishment decal "E"	1000/cs., 0,9 (2.0)	1000 each	5005 decal "E"
> Replenishment decal "F"	1000/cs., 0,9 (2.0)	1000 each	5005 decal "F"
> Replenishment decal "G"	1000/cs., 0,9 (2.0)	1000 each	5005 decal "G"
> Replenishment decal "H"	1000/cs., 0,9 (2.0)	1000 each	5005 decal "H"
> Replenishment decal "I"	1000/cs., 0,9 (2.0)	1000 each	5005 decal "I"
> Replenishment decal "J"	1000/cs., 0,9 (2.0)	1000 each	5005 decal "J"
> Replenishment decal "K"	1000/cs., 0,9 (2.0)	1000 each	5005 decal "K"
> Replenishment decal "L"	1000/cs., 0,9 (2.0)	1000 each	5005 decal "L"
> Replenishment decal "M"	1000/cs., 0,9 (2.0)	1000 each	5005 decal "M"
> Replenishment decal "N"	1000/cs., 0,9 (2.0)	1000 each	5005 decal "N"
> Replenishment decal "O"	1000/cs., 0,9 (2.0)	1000 each	5005 decal "O"
> Replenishment decal "P"	1000/cs., 0,9 (2.0)	1000 each	5005 decal "P"
> Replenishment decal "Q"	1000/cs., 0,9 (2.0)	1000 each	5005 decal "Q"
> Replenishment decal "R"	1000/cs., 0,9 (2.0)	1000 each	5005 decal "R"
> Replenishment decal "S"	1000/cs., 0,9 (2.0)	1000 each	5005 decal "S"
> Replenishment decal "T"	1000/cs., 0,9 (2.0)	1000 each	5005 decal "T"

2.2 Splice Protection Products

3M Scotchlite 5005 Reflective Lettering System Kit (continued)

Product Description	Packaging kg & (lbs.)/cs.	Minimum Order	Ref. No.
> Reflective lettering kit	1 kit/cs., 1,0 (2.4)	1 kit	5005 decal "kit"
> Replenishment decal "U"	1000/cs., 0,9 (2.0)	1000 each	5005 decal "U"
> Replenishment decal "V"	1000/cs., 0,9 (2.0)	1000 each	5005 decal "V"
> Replenishment decal "W"	1000/cs., 0,9 (2.0)	1000 each	5005 decal "W"
> Replenishment decal "X"	1000/cs., 0,9 (2.0)	1000 each	5005 decal "X"
> Replenishment decal "Y"	1000/cs., 0,9 (2.0)	1000 each	5005 decal "Y"
> Replenishment decal "Z"	1000/cs., 0,9 (2.0)	1000 each	5005 decal "Z"
> Replenishment decal "—"	1000/cs., 0,9 (2.0)	1000 each	5005 decal "—"
> Replenishment decal "BLANK"	1000/cs., 0,9 (2.0)	1000 each	5005 decal "BLANK"
> Replenishment decal "1"	1000/cs., 0,9 (2.0)	1000 each	5005 decal "1"
> Replenishment decal "2"	1000/cs., 0,9 (2.0)	1000 each	5005 decal "2"
> Replenishment decal "3"	1000/cs., 0,9 (2.0)	1000 each	5005 decal "3"
> Replenishment decal "4"	1000/cs., 0,9 (2.0)	1000 each	5005 decal "4"
> Replenishment decal "5"	1000/cs., 0,9 (2.0)	1000 each	5005 decal "5"
> Replenishment decal "6"	1000/cs., 0,9 (2.0)	1000 each	5005 decal "6"
> Replenishment decal "7"	1000/cs., 0,9 (2.0)	1000 each	5005 decal "7"
> Replenishment decal "8"	1000/cs., 0,9 (2.0)	1000 each	5005 decal "8"
> Replenishment decal "9"	1000/cs., 0,9 (2.0)	1000 each	5005 decal "9"

2.2 Splice Protection Products

Description - Miscellaneous Accessories



3M Scotchcast 4413 Filled Cable Cleaning Kit

A specially formulated cleaning solvent for cleaning grease and Flex-Gel filling compound from filled core cable without damaging connectors, cable or individual conductors. One bag will clean both cable ends at splice point. Comes complete with the right amount of solvent sealed in the bag. No special tools are required. Virtually no personnel contact with the solvent or solvent vapors occurs during cleaning because of the unique packaging concept.

Kit contents:

- Heat-sealed cleaning bag with solvent
- Pair gloves
- Puncture-protection bags (2)

Four different sizes are available to meet a wide range of applications.



3M Scotchcast 4414 Filled Cable Cleaning Kit

The Scotchcast 4414 Filled Cable Cleaning Kit provides all the necessary materials for cleaning the filling compound from filled copper and fibre optic cables in an easy-to-transport kit. This kit includes 15 pads saturated in cleaning solvent, five scraper pads and 10 towels. The specially formulated cleaning solvents are contained in premeasured portions on saturated pads for fast, easy, convenient solvent application to cable core after sheath has been removed. The solvent and wet pads effectively remove cable filling compound from conductors and connectors with no damage to either.

Kit contents:

- Solvent Saturated Pads (15)
- Scraper Pads (5)
- Towels (10)

Additional materials required:

- Scotchcast 4435 Sheath Scuff
- Scotch 88T Vinyl Tape



3M Scotchcast W-9 Channeling Wedge

The Scotchcast W-9 Channeling Wedge is used in separating bundles of conductors when plugging cable. Made of flexible plastic, tapered at one end and grooved, the W-9 wedge separates conductors to ensure maximum penetration of the compound when forming a plug.



3M Scotchcast 4415 Service Wire Cleaning Kit

Everything needed to clean troublesome filled service wire is included in the 4415 Kit. Solvent saturated pads are individually bagged for convenience. No extra tools are needed, and an instruction sheet is included in each kit

Kit contents:

- Towels (10)
- Solvent Saturated Pads (10)

2.2 Splice Protection Products

3M Scotchcast 4458, 4458-W Pair Saver



Protect cable pairs from the sharp edges of the shield and template, while permitting standard bond connector installations.

4458 Size: 21,6 mm x 5,4 m (0.85" x 18') rolls

4458-W Size: 38,0 mm x 5,5 m (1.5" x 18') rolls

Ordering Information

Miscellaneous Accessories

Product	Packaging kg & (lbs.)/cs.	Minimum Order	Ref. No.
4413 Filled Cable Cleaning Kit			
> or up to 200-pair cables	8/cs., 5,18 (11.5)	8 kits	4413-S
> or up to 600-pair cables	4/cs., 4,95 (11)	4 kits	4413-L
> Filled Cable Cleaning Kit	1/cs., 0,63 (1.4)	1 kit	CS 4414
> Service Wire Cleaning Kit	10/kit, 10 kits/cs., 3,3 (7.3)	10 kits	4415
4458, 4458-W Pair Saver			
> 21,6 mm x 5,4 m (.85" x 18') rolls	8/cs., 5,18 (11.5)	8 kits	4458
> 38 mm x 5,5 m (1.5" x 18') rolls	4/cs., 4,95 (11)	4 kits	4458-W
> Scotchcast W-9 Channeling Wedge	100/box, 1000/cs., 1,8 (4)	1000 each	W-9
> Replenishment decal "R"	1000/cs., 0,9 (2.0)	1000 each	5005 decal "R"
> Replenishment decal "S"	1000/cs., 0,9 (2.0)	1000 each	5005 decal "S"
> Replenishment decal "T"	1000/cs., 0,9 (2.0)	1000 each	5005 decal "T"

2.2 Splice Protection Products

Description - 3M™ Sheath Repair Products

3M Armorcast Structural Material

Armorcast Structural Material is a flexible fiberglass knit fabric strip saturated with black resin syrup then dried. No heat is required in the installation process, just water. It forms a tough durable covering that cures in just 20 minutes. For use on pressurised, non-pressurised, polyethylene or lead sheathed cable.



3M Armorcast 4560 Structural Material Bulk

Available in rolls of 1,5 m (5'), 3 m (10') and 4,57 m (15'), each 101,6 mm (4") wide. Each package contains five rolls and five pairs of gloves.



3M Scotch VM Tape Vinyl/Mastic

VM Tape seals out moisture and protects against corrosion without the need for heating tools. Two tapes in one (Vinyl and Mastic)—VM tape is especially designed for cable sheath repair, splice case and load coil case protection, auxiliary closure and cable reel end sealing, drop wire insulating, conduit repair and protection of CATV components plus many other general taping applications.

VM tape is a rubber based mastic laminated to an all weather 0,18 mm (7 mil) vinyl, which provides double duty protection in one wrap. Four sizes to meet all possible applications are available; 38 mm – 559 mm (1-1/2" – 22") width.

Size: 38 mm x 6 m (1-1/2" x 20')
101,6 mm x 3 m (4" x 10')
152 mm x 3 m (6" x 10')
559 mm x 3 m (22" x 10')

2.2 Splice Protection Products

Ordering Information

3M Sheath Repair Products

Product	Packaging kg & (lbs.)/cs.	Minimum Order	Ref. No.
4560 Armorcast Structural Material Bulk			
> (Bulk, 1,5 m (5'))	5 rolls, 0,63 (1.4)	5 rolls	4560-5
> (Bulk, 3 m (10'))	5 rolls, 1,27 (2.8)	5 rolls	4560-10
> (Bulk, 4,5 m (15'))	5 rolls, 1,86 (4.1)	5 rolls	4560-15
VM Vinyl/Mastic Tape			
> Size: 38 mm x 6 m (1-1/2" x 20')	1 roll/box, 10/cs., 2,5 (5.7)	10 rolls	VM-1.5x20
> 101,6 mm x 3 m (4" x 10')	1 roll/box, 10/cs., 6,2 (11.6)	10 rolls	VM-4x10
> 52 mm x 3 m (6" x 10')	1 roll/box, 1/cs., 0,9 (2)	1 roll	VM-6x10
> 559 mm x 3 m (22" x 10')	1 roll/box, 1/cs., 2,9 (6.9)	1 roll	VM-22x10

2.3 Cross Connection Product Range

Description - 3M™ SLIC™ Quick Connecting System

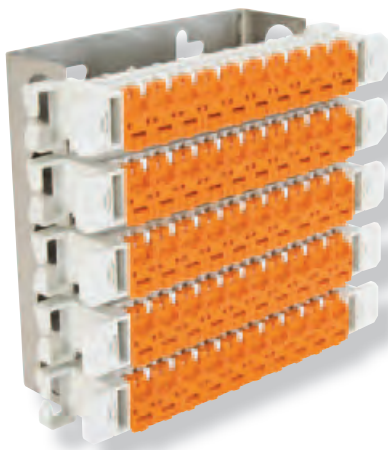

3M Quick Connect System 2810

Designed for your broadband network

The 3M Quick Connect System 2810 is the latest insulation displacement connector termination system from 3M, the company that invented the IDC more than 50 years ago. The QCS 2810 is a simple-to-use, tool-less copper block; an ideal solution for outside plant applications. Whether in cross-connect cabinets or at the edge of the network, the gel-filled, Cat. 5e compliant 2810 system is the solution.

New demands in an age of information

Every day, local loop providers work to provide enhanced customer services such as data access with faster Internet transmission, video-on-demand and video conferencing. Many providers are deploying ADSL2+ & VDSL2 over twisted pair copper cable to meet these demands. As new technologies migrate into the local loop, the importance of connections in the embedded plant increases. 3M provides connectors you can trust.

Visual confirmation without signal loss

Contact integrity is critical, not only at the time of installation but over the life of the connector. The QCS 2810 can be re-opened without breaking the circuit for visual validation of the IDC connection. High-integrity gel encapsulation protects against moisture and corrosion, and is designed to remain in place even after multiple wire insertions.

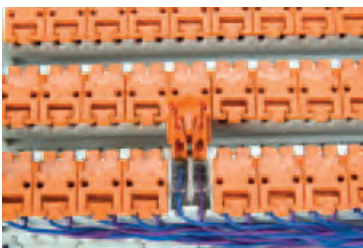

Features

- Tool-less jumpering
- Gelled interconnect
- Visibility to jumpers
- Category 5 performance
- Pair-at-once termination
- Low termination force

Benefits

- Simple termination practices increases technician productivity
- High integrity connection for network reliability & broadband performance
- Ability to inspect jumper termination allows validation of connection, minimizing rework
- Reliable high-speed data transmission exceeding VDSL2 frequencies
- Increases craft productivity
- Craft-friendly, tool-less design

2.3 Cross Connection Product Range

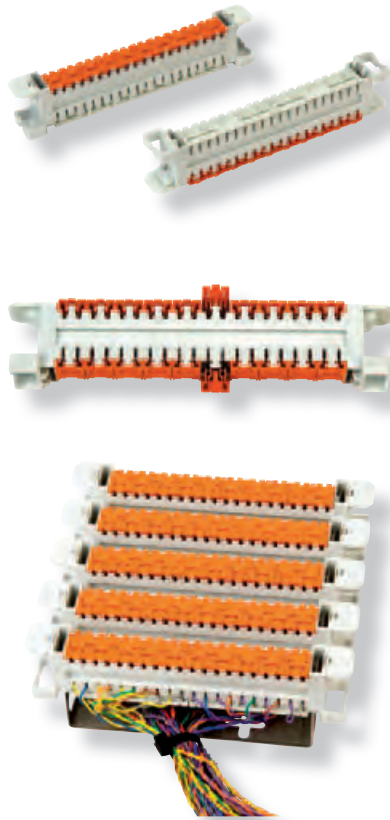

As you like it

The 3M Quick Connect System 2810 is available in models and frames to meet your application. The QCS 2810 system is modular in design. Termination blocks are available for pre-terminated applications in a 50-pair block or field-terminated applications in a 10-pair strip. In field terminated applications, the block fits on standard frames and is capable of terminating cable-side either with thumb actuation or with a convenient punch-down tool for increased productivity.

Field cable termination options

The 3M Quick Connect System 2810A: A 10-pair strip utilizing an IDC punch down tool to insert the cable wire into the back-side IDC element and trim the wire in one motion. This tool increases craft productivity in the installation of a cabinet, allowing the craft to prepare all ten cable pair that go to a given block and then to follow along with the tool and insert each wire in short order. Once the block is cabled and placed on the frame, the jumpering is completely tool-less. **The 3M Quick Connect System 2810B:** A 10-pair strip with completely tool-less termination. In this strip, the ergonomic jumper caps are located on the cable side as well as the jumper side allowing for tool free termination of the cables and tool-less jumpering. All terminations are pair-at-a-time.

Pre-terminated option

The 3M Quick Connect System 2810PT: The pre-terminated configuration of the QCS 2810 is available in 50-pair increments. The blocks come terminated with twisted-pair tails to 3M 710 or 3M MS² Modules. Different wire lengths and modules are available on request.

Applications

The Quick Connect System 2810 can be used throughout the network as the common interconnectivity and termination platform. Designed specifically for rugged use and robust performance in the outside plant, the QCS 2810 is ideal for use in Building Entrance Terminals (BET/PET), Network Interface Devices (NIDS), cable terminals and drops (buried, pedestal, strand or DP mount), cross-connect cabinets and remote terminals.

Technical Specifications

Dimensions:	Height	Width	Depth*
10-pair strip (not on frame)	20 mm / 0.79"	135 mm / 5.31"	26 mm / 1.02"
50-pair block (on frame, 25 mm pitch)	125 mm / 4.9"	135 mm / 5.31"	47 mm / 1.85"
50-pair block (on frame, 22.5 mm pitch)	112.5 mm / 4.4"	135 mm / 5.31"	47 mm / 1.85"

Wire range IDC contacts – solid copper conductor	0.4 mm to 0.6 mm	26 AWG to 22 AWG	
---	------------------	------------------	--

Wire re-terminations:
250 re-terminations of 24 AWG per
Telcordia TR-NWT-001195

2.3 Cross Connection Product Range

Specifications

Electrical

- Insulation resistance: $>1 \times 10^{10} \Omega$
- Contact resistance: $< 10 \text{ m}\Omega$
- Dielectric strength: 3000 V rms, 60 Hz AC
- High voltage surge: 3000 V DC Surge

Broadband

- EIA/TIA 568B.2 Category 5e component compliant

Environmental

Telcordia TR-NWT-001195

- "In process" "Generic Requirements for Insulation Displacement Connector (IDC) Cross-Connect Terminal Blocks"
- Operating temperature range: -20°C to 60°C
- Storage temperature range: -40°C to 90°C
- RoHS: Compliant with EU RoHS Directive (2005/95/EC)

Materials

- Plastics: Thermoplastic
- Contacts: Bronze, Tin (Sn) plating

Ordering Information

	Ref. No.
> Type A cross-connect SOR-Orange 10 pair connection module	2810A-0
> Type B cross-connect tool-less field termination - Orange 10 pair connection module	2810B-0
> Label holder for 2810	2810L
> Replacement cap - Orange	2810RC-0
> Priority cap - Red	2810PC-R
> Single-pair test probe	2827
> Cable wire termination tool—SOR OC	C234056A0000

2.3 Cross Connection Product Range

Description - Connection modules SID™ C

SID-C connection and disconnection cable terminal blocks



With the SID-C product family 3M is setting the standards for high density IDC termination combined with improved handling within applications in main telecommunications and data networks.

The SID-C insulation displacement contacts are enclosed by the plastic housing of the module. This improves the insulation performance and helps in providing a safer working practice.

Using SID-C within the InCa cross connection cabinets increases the capacity from 300 to 400 pairs, per vertical. This results in the capacity of the cabinet increasing to 1600 pairs (instead of 1200 pairs), without affecting the well-proved handling of the cabinet.

A wide range of accessories and a comprehensive overvoltage protection solution complete the product family.

Specifications

- High density
- One wire per slot 0.32 - 0.80 mm
- Optimised cable conductor guide
- Long-life tools
- Flexible mounting systems
- Removal without the need for special tooling
- Comprehensive overvoltage protection system



2.3 Cross Connection Product Range

Ordering Information

Connection modules SID™-C

The compact SID-C connection and disconnection cable terminal blocks provide orderly termination of plastic-coated cable conductors and jumper wires. They are suitable for fitting on distribution frames, in cabinets.

Design:

- SID cable terminal block, fitted with SID connection modules 10 pairs;
- SID cable terminal block, fitted with SID disconnection modules; 10 pairs, each in units of 50 and 100 pairs.

Each block is equipped with:

SID-C cable terminal block back mount frame, for either 5 or 10 connection modules / disconnection modules (10 pairs)

- 1 Label holder;
- 1 Plug-in number set;
- 1 Dust cover;
- 1 Fixing set for mounting between two frame rails.



SID-C cable terminal block 50 pairs

- > **SID-C cable terminal block** with 5 disconnection modules for 50 pairs
 - PU: 1 pc, Weight: 0,45 kg

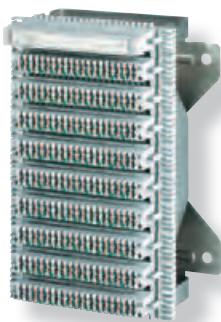

SID-C cable terminal block 100 pairs

- > **SID-C cable terminal block** with 10 connection modules for 100 pairs
 - PU: 1 pc, Weight: 0,8 kg
- > **SID-C cable terminal block** with 10 disconnection modules for 100 pairs
 - PU: 1 pc, Weight: 0,8 kg

Ref. No.

15-050-00400

10-100-00425

15-100-00425

2.3 Cross Connection Product Range

Description - Connection modules SID™ C EXTREME

SID-C EXTREME concept for extreme conditions

The SID-C EXTREME system has been introduced to provide increased environmental protection for cross connection systems located with harsh environments.

The concept allows the operator the opportunity to provide the level of protection suitable for each separate location.

BASIC DUST PROTECTION

Basic protection against dust ingress.



BASIC AMBIENT PROTECTION

For protection against contamination, corrosive atmospheres, and increased atmospheric humidity.

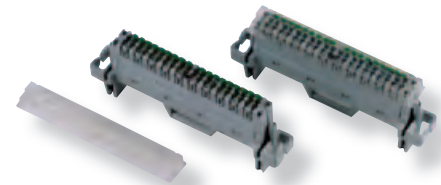

Specifications

- Improved reliability
- Low cost solution
- High density
- Suitable for all applications

Ordering Information

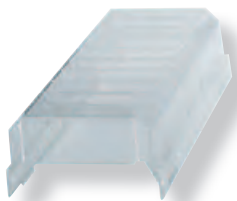

> Dust protection cover

- 100 pairs, grid 17,5
- PU: 1 pc

Ref. No.

15014-505 00



> SID-C disconnection modules

- 10 pairs, gel filled, with dust protection caps
- PU: 10 pcs

Ref. No.

79103-534 35

2.4 Distribution Point Product Range

Description - High reliability drop wire connectors MX 2000

MX 2000 high reliability connection module for overhead plant

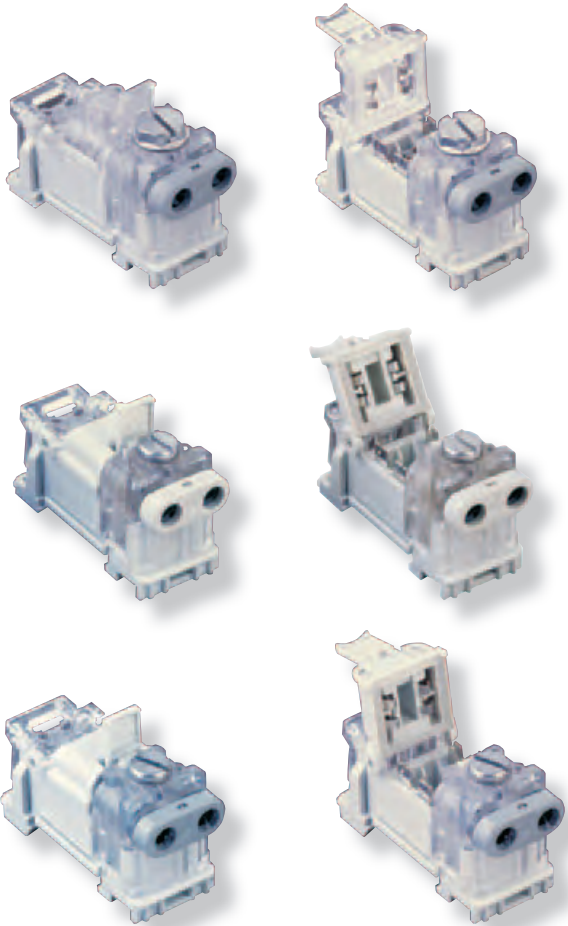

MX 2000 dropwire connectors are in use world wide to build and upgrade overhead networks with a fully watertight connection technology. When considering the fact that the highest fault rates are measured in overhead networks, it's indispensable to use a high reliable technology like MX 2000.

MX 2000 is designed to operate under harshest environmental conditions. The user friendly design prevents any possible incorrect installations.

This product is suitable for distribution, protection as well as customer termination in overhead lines. This new generation fits all existing networks and can accommodate all existing dropwire sizes, whatever the core conductor material is (copperweld, steel, bronze, copper cadmium).

No specific tools are required to perform IDC termination, a simple screw driver eases the dropwire termination. Both sides of this connector can be re-terminated multiple times with different conductor sizes.

A central disconnection area offers test facilities for both sides; multipair testing; disconnection and overvoltage protection. The overvoltage protected version is able to drain high currents up to 10kA.

The very flexible built-in protection allows to upgrade unprotected distribution points into protected ones.

The unique MX 2000 design allows to snap this modules on both IEC 715 25mm and 35mm profiles.

Earthing (10kA) is automatically completed through this mounting rail. The MX 2000 one pair module offers a very high flexibility compared to multipair systems.

Specifications

- Watertight encapsulated contacts
- No specific termination tool needed
- for 0,4 to 1,1 mm dropwire conductors (all kinds of materials)
- Multiple re-terminations possible
- Comprehensive product range
- 10kA drain current capacity

2.4 Distribution Point Product Range

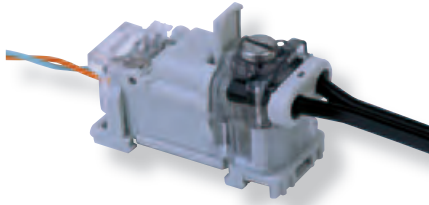

Technical Specifications

Dropwire terminations

- Screwdriver operated IDC
- Steel, copperweld, copper cadmium, bronze drop-wires
- From 0,4 to 1,1 mm conductor diameter copper wires
- Overall insulation diameter: 5 mm max.

Cable termination

- Tool free IDC
- Solid copper conductors
- From 0,4 to 0,8 mm conductor gauges
- Overall insulation diameter: 1,8 mm max.

Ordering Information



- > **MX 2000 C**
disconnection module

Ref. No.

C249800A0000



- > **MX 2000**
disconnection module with protection facility
(delivered without protection arrester, please consult us)

C249801A0000



- > **MX 2000 PP**
protection module equipped with 250 V surge arrester with fail-safe and PTCR

C249812A0000



- > **MX 2000 T**
disconnection module with protection and test facility
without interrupting the service

C249811A0000

- > **MX 2000 P**
protection module equipped with 250 V surge arrester with fail-safe

C249802A0000

- > **Three-pole surge arrester**
for MX 2000 **250 V** with fail-safe

C231039A0000

2.4 Distribution Point Product Range

Description - Drop wire distribution points Overview

MX modules for outside plant

	MX 2000 C	MX 2000	MX 2000 P	MX 2000 P 350 V
General product features				
single pair configuration	yes	yes	yes	yes
type of drop wire	all	all	all	all
mounting	clip on both DIN 35 and DIN 25	clip on both DIN 35 and DIN 25	clip on both DIN 35 and DIN 25	clip on both DIN 35 and DIN 25
retermination on dropwire side	yes	yes	yes	yes
retermination on cable side	yes	yes	yes	yes
disconnection	yes	yes	yes	yes
protection	yes	upgradable	yes	yes
test	yes	yes	yes	yes
DROP WIRE				
type of termination (operation of IDC)	screwdriver	screwdriver	screwdriver	screwdriver
-> conductor diameters	0,4 -1,1 mm	0,4 -1,1 mm	0,4 -1,1 mm	0,4 -1,1 mm
-> overall insulation diameter	5 mm max	5 mm max	5 mm max	5 mm max
-> overall insulation diameter	copper, bronze, steel	copper, bronze, steel	copper, bronze, steel	copper, bronze, steel
number of reterminations with same drop wire	30	30	30	30
number of reterminations with different diameters (typical)	10	10	10	10
CABLE				
type of termination (operation of IDC)	tool free or screwdriver	tool free or screwdriver	tool free or screwdriver	tool free or screwdriver
-> conductor diameters	0,4 - 0,8 mm	0,4 - 0,8 mm	0,4 - 0,8 mm	0,4 - 0,8 mm
-> overall insulation diameter	1,8 mm max	1,8 mm max	1,8 mm max	1,8 mm max
-> conductor material	copper	copper	copper	copper
number of reterminations with same cable				
number of reterminations with different diameters (typical)				
Electrical features				
contact resistance	< 3mΩ	< 3mΩ		< 1mΩ
leading through resistance	< 20mΩ	< 10mΩ	< 10mΩ	< 10mΩ
insulation resistance @ 500 V	> 10 GΩ	> 10 GΩ	> 10 GΩ	> 10 GΩ
dielectric strength @ 50 Hz	5 kV RMS-50 Hz	5 kV RMS-50 Hz		
protection				
type of protection	-	upgradable	built-in	built-in
protection when line is disconnected (detent position)	-	yes	yes	yes
replaceable components	-	yes	yes	yes
static breakdown voltage	-	250 V +/-20%	250 V +/-20%	350 V +/-20%
dynamic breakdown voltage	-	< 800 V	< 800 V	< 800 V
impulse discharge current @ 8/20 μs	-	10 kA	10 kA	10 kA
alternative discharge current @ 50 Hz	-	< 10 kA	< 10 kA	< 10 kA
fail safe response time @ 5 A	-	< 10 s	< 10 s	< 10 s
test				
4 points	yes	yes	yes	yes
test probe	crocodile clamps	crocodile clamps	crocodile clamps	crocodile clamps
multipair test (2)	yes	yes	yes	yes
design features				
plastic materials	polycarbonate	polycarbonate	polycarbonate	polycarbonate
contact material	CuSn9P	CuSn9P	CuSn9P	CuSn9P
contact coating	tin/lead 60/40	tin/lead 60/40	tin/lead 60/40	tin/lead 60/40
self-extinguishing plastic material class	UL 94 V0	UL 94 V0	UL 94 V0	UL 94 V0
colour	clear plastic and grey	clear plastic and grey	clear plastic and grey	clear plastic and grey
watertightness				
self-healing feature	yes	yes	yes	yes
working conditions				
immersion test under 48 V	yes	yes	yes	yes
working temperatures	-30 to + 200°C	-30 to + 200°C	-30 to + 200°C	-30 to + 200°C

2.4 Distribution Point Product Range

Description - Drop wire distribution points Overview

Range of outdoor boxes for outside plant

	3M™ BMX	3M™ BDX3000	3M™ ATS 2000**	3M™ EDB
Applications				
application	dropwire distribution and protection box	multipurpose	dropwire distribution and protection box	Multipair IDC block distribution box
possible internal equipment capacities	MX 2000* or classic 10, 20, 30, 50 pairs	MX*, SID*, STS*, MX2000*, STG2000*	MX 2000* 1, 5, 10, 20, 30pairs	SID-C, Slic™ QCS, QSA, SID-CT, STG2000K
Product features				
pole mounting	mounting bracket or steel band	mounting bracket	no bracket, screw or steel band	No bracket, with screws
wall mounting	with or without bracket	without bracket	without bracket	No bracket, with screws
type of cover	10 pairs: hinged others: sliding cover	hinged	hinged	hinged
type of box	5 types	6 types	4 types	1 type
type of lock	optional lock with key	optional lock with key	snap lock	screw
cable ties	yes	optional	no	no
cable routing devices	yes	optional	no	no
Technical features				
type of material	10 pairs: PVC 20, 30,50 pairs: polyester re-Inforced fibre glass	PVC	polycarbonate	Fibre reinforced polycarbonate
UV resistance	yes	yes	yes	yes
colour	light grey	light/dark grey	light grey	light grey
standard water tightness (NFC 20015)	10 pairs: IK 08 others: IK 10	IK 07	IK 07	IK 07
self-extinguishible material (UL 94)	UL94 V0	V0	V0	V0
temperature range	-25°to +70°C	-25°to +70°C	-25°to +70°C	-25°to +70°C
Outside dimensions (w x h x d) in mm				
-> size 1 hinged	240 x 270 x 80	255 x 292 x 86	41 x 95 x 67	116 x 230 x 95
-> size 2	240 x 320 x 73	255 x 292 x 116	204 x 248 x 71	
-> size 3	240 x 511 x 73	255 x 292 x 156	204 x 372 x 71	
-> size 4	240 x 856 x 73	255 x 400 x 86	204 x 422 x 71	
-> size 5 sliding	240 x 213 x 73	255 x 400 x 116		
-> size 6	-	255 x 400 x 156		

** Values should be reconfirmed

* These products are trademarked by Quante.

2.4 Distribution Point Product Range

Description - Drop wire distribution points 3M™ BMX

3M BMX 10-50 pair distribution box Application



The boxes in the BMX range are used for connecting and protecting subscriber lines and terminals. Developed to accommodate the MX connection modules, they guarantee the operator reliable and consistent connection assemblies.

Numerous configuration are possible:

- 4 box sizes for distribution and secondary cross connection applications
- hinged lid available (10 pair only)
- standard sizes from 10 to 50 pairs
- connection modules can be installed when required.

Easy to assemble:

- rubber 'press-out' cable entries
- equipped with cable routing devices.

Simple to operate and maintain:

- boxes are compatible with all types of supports
- modular connections starting from one pair
- MX module insulation displacement contact reduces cabling time
- total reliability due to watertight connections
- high capacity boxes are aimed to be used as transition point between underground and overhead networks. It is recommended to offer a protection at this point in the network as electronic devices can be installed in the network. For these applications BMX boxes are made of glass fibre reinforced polyester to withstand specific conditions due to the location at the top of the pole.
- In the 10 pair box, multipair cable can 'loop through' the box with only the 10 distributed pairs required taped out. As a result, one 50 pair cable can feed 5 distribution boxes without using any additional overhead joint closure.

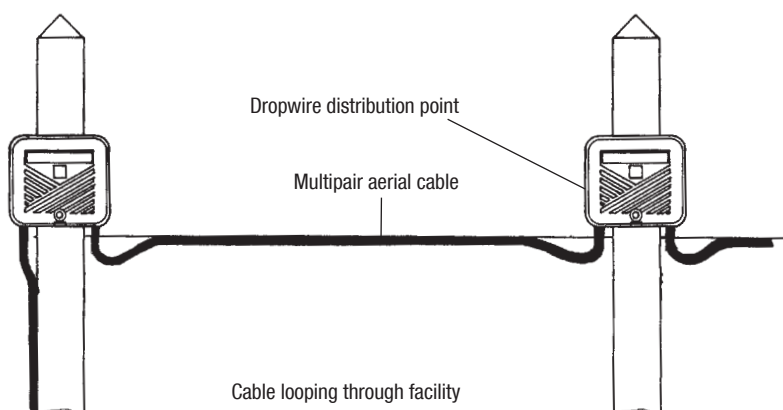

Specifications

- Comprehensive range
- Enhanced weather-proofing
- Insect proof
- Automatic lid closure
- Swivelling cover (10 pairs)
- Protection of the incoming cables
- Accommodate all types of MX modules
- Glass fibre reinforced polyester for large capacities

Model	10 pairs	10 pairs	20 pairs	30 pairs	40 pairs	100 pairs**
Width (mm)	240	240	240	240	240	240
Height (mm)	270	213	320	511	856	856
Depth (mm)	80	73	73	73	73	73
Cover	swivelling	sliding	sliding	sliding	sliding	sliding

** The 100 pair configurations are achieved by assembling two 50 pair boxes.

2.4 Distribution Point Product Range

Ordering Information

Distribution/protection boxes

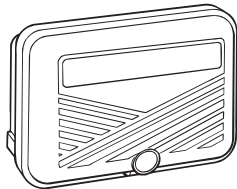

This box can not be mounted directly with stainless steel 7/10 bracket

- > 10 pair empty box with swivelling cover, rail and earth post

Ref. No.

N501187A0000

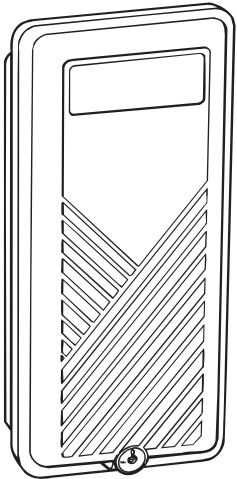

These boxes can be pole mounted directly with stainless steel 7/10 bracket

- > 10 pair empty box with sliding cover, rail and earth post
 - (MX classic)

NN3450600000

- > Mounting bracket
 - (France Telecom)

NN8809590000

- > 20 pair empty box with sliding cover, rail and earth post
 - (MX 2000)

N451054A0000

- > Mounting frame
 - (20 pair)

NN7803400000

- > 30 pair empty box with sliding
 - (MX 2000)

N451055A0000

- > Mounting frame
 - (28/30 pair)

NN7803410000

- > 50 pair empty box with sliding cover, rail and earth post
 - (MX 2000)

N451056A0000

- > Mounting frame
 - (50/56 pair)

NN7803420000

- > Key lock kit

N691009A0000

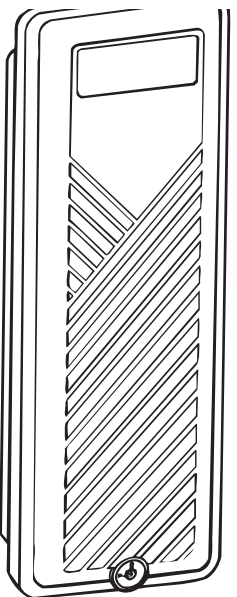

2.4 Distribution Point Product Range

Description - Drop wire distribution points 3M™ BDX



3M BDX Multipurpose outdoor box

BDX boxes are designed to accommodate different equipment configurations in outside plant. Based on a modular concept, 2 sizes of BDX box are available each with the choice of three different hinged front cover depths.

A slotted internal base allows the mounting equipment whatever the position. The specific grooves are designed to mount the equipment with specific self-tapping screws.

BDX can be equipped with specific strain relief devices for drop wire distribution applications. They are equipped with a gasket and rubber grommets in the cable entry area. The relevant protection class is IP 55.

Suitable for both pole and wall mount applications via a steel strap for pole mount and direct mount without additional mounting bracket for wall mounted applications.

BDX boxes can be secured with either a triangular shaped nut or a standard key type lock. The standard colour is light grey for the cover and dark grey for the base. Additional colours may be ordered upon request.

A specific version with reinforced ventilation is available to accommodate any electronic equipment.

Material

- Thermoplastic

Colours

- Base: dark grey RAL 7037
- Cover: light grey RAL 7035 (Ivory or black available upon request)

Dielectrical strength

- > 4 kV

Degree of protection (EN 60 529 standard)

- IP 43 without rubber seal
- IP 55 with rubber

Mounting

- By 20 mm metal strap
- On a standard RP-type fixing bracket
- By screws (4 x Ø 6 mm)

Specifications

- 3 depths available
- Free mounting with self tapping screws
- Outstanding weather proofness (IP55)
- Lockable
- Specific version with reinforced ventilation for electronic equipment.

2.4 Distribution Point Product Range

Technical Specifications

Types	Box	Width	Height	Depth
External dimensions (mm)				
Size 1 low cover (T1 B)	BDX 3000	255	292	86
Size 1 medium cover (T1 M)	BDX 3000	255	292	116
Size 1 high cover (T1 H)	BDX 3000	255	292	156
Size 2 low cover (T2 B)	BDX 3000	255	400	86
Size 2 medium cover (T2 M)	BDX 3000	255	400	116
Size 2 high cover (T2 H)	BDX 3000	255	400	156

Types	Box	Width	Height	Depth slotted bottom	Depth plain bottom
Maximum internal dimensions (mm)					
T1 B	BDX 3000	230	190	60	70
T1 M	BDX 3000	230	190	90	100
T1 H	BDX 3000	230	190	130	140
T2 B	BDX 3000	230	300	60	70
T2 M	BDX 3000	230	300	90	100
T2 H	BDX 3000	230	300	130	140

Ordering Information

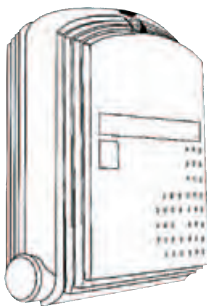

3M BDX 3000 boxes

Made up of:

- Body with bottom entirely slotted (FR)
- Hinged cover with built-in locking system
- Strong watertightness
- ETR: Body/cover sealing ring
- Sealing on cable entry
- Ventilation on high side

Colours:

- Base: dark grey
- Cover: light grey
(Ivory and black upon request)

	Ref. No.
> T1 B ETR FR	N501053A0000
> T1 M ETR FR	N501054A0000
> T1 H ETR FR	N501055A0000
> T2 B ETR FR	N501056A0000
> T2 M ETR FR	N501057A0000
> T2 H ETR FR	N501058A0000

2.4 Distribution Point Product Range

Ordering Information

Accessories for 3M BDX Multipurpose outdoor box

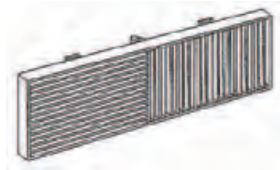

> **Set of slotted right angles (EQR)**

Mounting at 90° on materials in boxes by self-tapping screws Ø 3 mm
 Right angle size: 215 x 70 mm
 Compatible with all boxes
 Automatically delivered in FL EQR boxes

Ref. No.

N711119A0000

> **Set of 10 quarter turn triangles**

Compatible with all covers
 Can be mounted on site

N691022A0000

> **Set of 10 key-locks No 1242 E**



Other numbers upon request

NN3690310000

2.4 Distribution Point Product Range

Description - Protection and mechanical resistance for enclosures

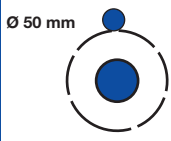
IP protection degree for enclosures of electrical equipment according to EN 60 529 standard.
IK shock protection according to EN 50 102 draft standard.

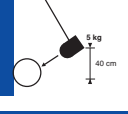
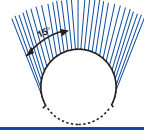
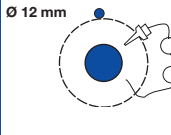
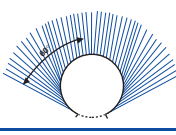
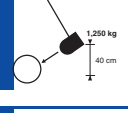
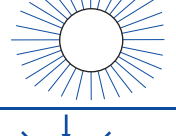
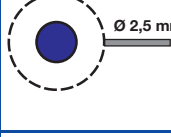
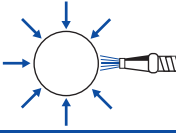
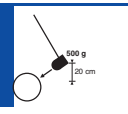
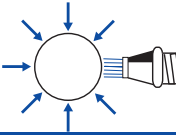
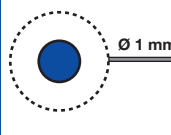
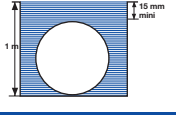
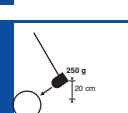
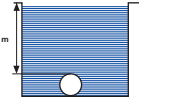
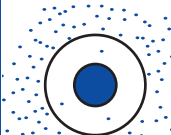
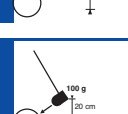
1st digit: Protection against solid bodies			2nd digit: Protection against liquids			Protection against mechanical impacts		
IP		TEST	IP		TEST			TEST
0	No protection		0	No protection		0	No protection	
1	Protection against solid bodies greater than 50 mm (e.g. inadvertent hand contact)		1	Protection against dripping water falling vertically (condensation)		1	Impact energy 0.150 joule	
			2	Protection against water drops falling up to 15° from the vertical				2
2	Protection against solid bodies greater than 12 mm (e.g. fingers)		3	Protection against rainwater falling up to 60° from the vertical		3	Impact energy 0.350 joule	
			4	Protection against splashing water from all directions				4
3	Protection against solid bodies greater than 2,5 mm (e.g. tools, wires)		5	Protection against water jets from all directions		5	Impact energy 0.700 joule	
			6	Protection against splashing water comparable with large waves				6
4	Protection against solid bodies greater than 1 mm (e.g. precision tools, small wires)		7	Protection against the effects of immersion		7	Impact energy 2.00 joules	
			8	Protection against the effects of prolonged immersion in specified conditions				8
5	Protection against dust (no aggressive deposits)		8			9	Impact energy 10.00 joules	
								6

2.4 Distribution Point Product Range

Description - Cross connection product range

3M DDB

3M™ DDB, Durable Distribution Box for copper cable based networks is designed to accommodate SID™ -CT or QSA modules. The box is prepared for surge protection. Locking system is optional available.

- Housing with hinged cover (DDB 200 with door)
- Opening of the covers approx. 110° (DDB200 180°)
- Prepared for mounting on wall or pole (wood, metal or concrete)
- No additional pole mounting kit necessary
- Protection class IP 54 / IP 64 with sealing
- Cable sheath grounding clamp

Material

- Housing: PC/ABS, UV resistant, UL94 V-0
- Cover: glass-fibre reinforced polyester colour RAL 7032
- Grommets: polyethylene, UV resistant
- Back mount frame: stainless steel
- Screws: stainless steel
- Cable sheath grounding clamp: steel tin plated

Delivery content

- DDB Box with back mount frame for SID™ -CT / QSA modules, with Cable sheath grounding clamp

Ordering Information



> DDB 20

- 173 x 137 x 87mm empty housing with mounting plate for 2 modules, supplementary kit lock available (OVP with SID-CT not possible) cable entry:
- 3x for cable diameter up to 14,7 mm (2x with assembled lock)
 - 1x for cable diameter up to 9 mm (for earth connection)
 - 1x for cable diameter up to 23 mm

Ref. No.

25-020-01200

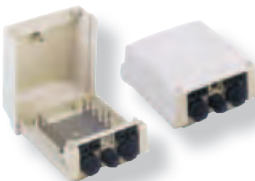

> DDB 50

- 210 x 191 x 108 mm empty housing with mounting plate for 5 modules, supplementary kit lock available cable entry:
- 1 x for cable diameter up to 23 mm
 - 2 x for cable diameter up to 32 mm
 - 4x for cable diameter up to 14,7 mm
 - 1x for cable diameter up to 9 mm (for earth connection)

25-050-01200



> DDB 100

- 390 x 223 x 124 mm empty housing with mounting plate for 10 modules, supplementary kit lock available cable entry:
- 3 x for cable diameter up to 32 mm
 - 4 x for cable diameter up to 23 mm
 - 1 x for cable diameter up to 9 mm (for earth connection)

25-100-01200

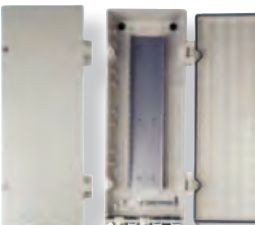

> DDB 200

- 640 x 238 x 125 mm only for wall mounting, empty housing with mounting plate for 20 modules, PG 36 cable, screwing, supplementary kit lock available (OVP with SID-CT not possible) cable entry:
- 2 x for cable diameter up to 35 mm (PG36)
 - 1 x for cable diameter up to 23 mm
 - 3 x for cable diameter up to 18 mm
 - 4 x for cable diameter up to 13 mm

25-200-01200

2.4 Distribution Point Product Range

Ordering Information

Accessories for 3M DDB Boxes

- > supplementary kit lock SL 158 for DDB 20
- > supplementary kit lock SL 158 for DDB 50/100
- > supplementary kit sealing 1 m (for DDB 200 not necessary)

Ref. No.

25096-500 00

25096-501 00

25096-502 00

Modules see pg. 7 - 8, 25 and 41 - 46

2.4 Distribution Point Product Range

Description - Cross connection product range 3M™ CDS

3M CDS secondary cross connection boxes



CDS range of products are used for cross connection in the secondary network. Made up of 2 verticals, incoming and outgoing cables can be easily identified. The standard boxes are equipped with Europe E10 backmount frame to accommodate the STG range of connection modules or SX high reliability terminal block. These boxes are designed for pole or wall mount applications with the relevant mounting brackets.

Manufactured in glass fibre reinforced polyester the mechanical resistance is appropriate for use at the base of poles. With an IP44 protection rating the CDS box offers good resistance to weather and insect ingress in external plant application.

The boxes are delivered as standard, with the following: earth post, strain relief devices, jumper routing devices.

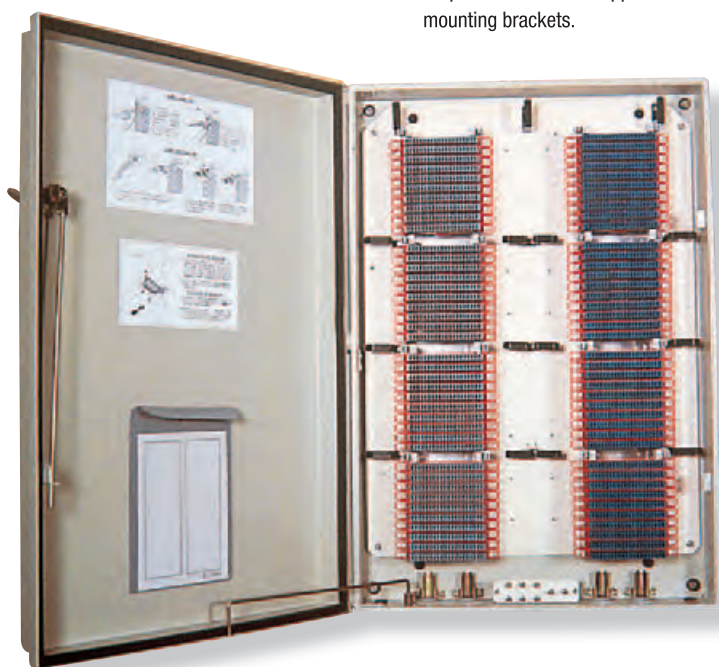

CDS 400 / 600 / 800 pair box

- 3 sizes available
- CDS box is delivered without backmount frames
- Locking by triangular shaped nut
- Hinged cover with wind latch

Specifications

- Comprehensive range
- From 300 to 800 pairs
- Water and insect proof
- Good mechanical resistance

Technical Specifications

Type	Capacity		Overall dimensions (mm)		
	STG	SID	Height	Width	Depth
CDS 400	400	400	446	406	117
CDS 600	600	500	606	436	117
CDS 800	800	700	766	436	117

2.4 Distribution Point Product Range

Ordering Information

3M CDS boxes

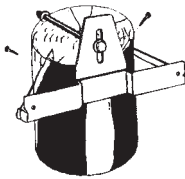
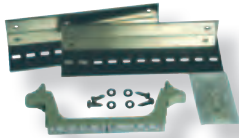
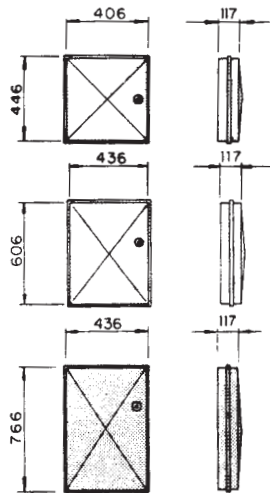

> **400 pair box**
with jumper routing devices

Ref. No.

To be advised

> **600 pair box**
with jumper routing devices

To be advised

> **800 pair box**
with jumper routing devices

To be advised

> **"L type" profile for mounting of 10 STG modules**
(100 pairs)

To be advised

Accessories for CDS boxes

> **Pole support**

To be advised

2.5 Copper Test Equipment

Description

3M Dynatel Advanced Modular System 965AMS

Your network is down. Try diagnosing it with some testers, and they'll show you that the service isn't working. Which you already know.

Rather than just testing the network service, the new 3M Dynatel Advanced Modular System 965AMS tests the integrity of the physical media layer. With this new family of Dynatel testers, you can determine what your line problem is, where it is and what's causing it.

Modems come and go. It's the media that matters.

Unlike some testers, Dynatel tests the integrity of the physical media layer. With its full-featured DSL-specific wideband and POTS testing, one technician may quickly, easily and accurately pinpoint the location and extent of each problem. The line can then be repaired and re-qualified for future reference.

Built for the real world. Because you work in the real world.

The new 3M Dynatel Advanced Modular System 965AMS meets or exceeds Broadband Forum and IEEE standards, can be fully immersed, survive a five-foot drop and still perform. This durable workhorse even works at 0 degrees Fahrenheit.

30 years of technology at your service.

With the 3M Dynatel Advanced Modular System 965AMS, a field technician gains the accumulated knowledge of over 30 years in advanced testing and technology from the leader in copper testing. Plus new capabilities.

For instance, its enhanced TDR capabilities allow you to trace and locate troublesome faults that are difficult, if not impossible, to do with other testers, which can help reduce repeat calls and save you money.

And with the advanced 3M Dynatel Fault Sense technology in its Auto Test and Auto TDR functions, it not only tells you what the fault is, it actually makes decisions and recommendations for you on the next steps to fix the trouble.

The future of testing.

Modems come and go. It's the media that matters, and 3M Dynatel products are known for media tests. It's been that way for 30 years, and we're making sure it stays that way for years to come with aggressive R&D and advanced copper test capabilities that not only measure, but analyze the network.

So now you know.



2.5 Copper Test Equipment



The complete testing platform for outside plant telecommunications

This flexible test set provides full-featured testing for the triple play—voice, video and data circuits. Because it's a 3M Dynatel Advanced Modular System 965 series, the AMS model is easy to use, requiring minimal training for testing professionals. And because it emphasizes fault diagnosis and location, customer problems can be solved quickly.

The 965AMS family includes three product tiers. There is the value-priced tier, the 3M Dynatel 965AMS Lite series. This entry-level copper test platform includes POTS, VOM and RFL functions with optional TDR capability. The 965AMS Lite is fully upgradable to the 965AMS and 965AMS Pro Models. The 965AMS adds as standard features wideband loss/tone (up to 2MHz), voiceband spectrum analyzer, and Expert Pair Autotest. The 965AMSPro series is the most comprehensive product tier including Spectrum Analyzer, Enhanced Wideband Test Suite, and optional 30MHz test capability with the 3M Dynatel SA30 and 3M Dynatel Far End Device III.

Autotest

The knowledge-based smart autotest function is the product of more than a hundred years of accumulated Dynatel team experience. It conducts an automatic test of active and inactive pairs with pass/fail limits. Autotest capabilities also include 3M Dynatel Fault Sense analysis of test results with advice on how to repair or locate faults. 3M Far End Device type and service based selections of tests are supported by the autotest feature of the 965AMS platform.

External modules

The 3M Dynatel Advanced Modular System 965AMS modules are field swappable, providing the exact testing interface needed for each job. Modules support technicians who work on a variety of circuits during a typical day. Because the modules are field swappable, the technicians can share them. Because they are rugged, there is little worry about breaking them. Contact 3M for a list of available modules.

Rugged, weather-resistant design

The handheld 965AMS product is housed in a lightweight, ergonomically designed case for portability and ease of handling. The unit is weather-resistant and weighs only 3.3 lbs (1.5 kg). It's at home on a desktop, on the ground, up in an aerial environment and in underground locations.

The Dynatel brand and the distinctive Dynatel yellow case are your indication of rugged dependability

Features

- Communications
- Flexible architecture
- Graphical user interface
- Help function
- Big, bright screen
- Backlight
- Keypad
- LED indicators
- Modular design
- 3M Dynatel Fault Sense
- Dynatel brand promise

Benefits

- Capability to connect directly with a PC or notebook computer for software upload and data downloads
- Industry standard Microsoft Windows CE operating system
- User-friendly, icon-based display of test results
- Internal help provides information as needed during operation
- Highly visible even in bright sunlight with proprietary 3M Vikuiti Brightness Enhancement Technology; 80% larger than 965DSP
- For use in low light work areas
- Allows rapid access to 12 different "blue key" functions, reducing menu levels. Also has cursors and supports alpha-numeric entry
- Signal battery state and communication status
- Simply replace modules to change test capability (no need to replace test set)
- TDR and Autotest knowledge-based systems aid technicians with test interpretation
- Rugged, dependable, accurate

2.5 Copper Test Equipment

Features

- Interconnectivity
 - RS232
 - USB Active Sync client 1.1
 - Battery charger port
 - Test lead connectors
- Basic VOM
 - Voltage
 - Current
 - Resistance
 - Soak test
 - Opens
 - Resistance fault location
 - Special resistance
 - Wet section test
 - Ringers
 - Ground resistance
 - ID tone
 - Kick test
- Voiceband tests
 - Load coil count
 - Loss
 - Noise
 - Longitudinal balance
 - Level trace
 - Tone
 - Autotest
 - Dialing
 - Microphone and speaker
 - Caller ID functionality
 - Voiceband spectrum analyzer
- Standard Wideband
 - Wideband loss
 - Wideband tone

Benefits/Descriptions

- Requires serial adapter cable
- Requires USB adapter cable
- Basic Line Tests
 - Detects and measures the presence of central office (exchange) or foreign DC or AC voltages, including ringing voltages
 - Measures DC loop current with a 430-ohm shunt resistance
 - Measures conductor and insulation resistance up to 1 Giga Ohm
 - High voltage extended period resistance measurement to expose corrosion-induced faults
 - Locates opens at distances up to 100,000 ft. (30 km)
 - Displays distance to fault
 - Measures the loop resistance and the resistance difference (resistive balance) between two conductors on a pair
 - Allows RFL measurement when both wires in a pair are faulted and there is no separate good pair available
 - Measures and displays capacitance associated with one or more ringers and the equivalent count
 - Measures the resistance of the ground path
 - High power interrupted signal for pair tracing and identification
 - Rapid combination of resistance, voltage and opens for quickly evaluating cable pairs
- Noise, loss, tone, longitudinal balance, load coil counting and FED compatibility
 - Indicates the presence of load coils in a loop circuit and distance to the first load coil
 - Measures voiceband loss
 - Measures noise metallic and noise to ground in dBmC or dBm0p
 - Provides active measurement of line balance
 - Measures and displays the impedance of the line as a function of frequency
 - Provides test tones for conductor identification and transmission testing. 10 default tones, user selectable. Voiceband to 20 kHz, ID tones to 1 kHz
 - Supports 3M™ Far End Device (FED II and III)
 - Offhook, dialing capability, monitoring capability
 - Speaker has 1-watt power output for noisy environments
 - Displays number, name, date, and time
 - Displays active noise and longitudinal signals from 1 Hz to 8,000 Hz using dBmC or flat filter
- This feature set is enabled in the Standard and Pro models
 - Measures wideband signals from 20 kHz to 2.2 MHz
 - Provides test tones from 20 kHz to 2.2 MHz at 0dBm

Optional Features

- TDR Modes
 - Single trace
 - Dual trace
 - Differential
 - Crosstalk
 - Memory
 - Memory differential
 - Peak
 - Live differential
- Wideband Expanded
 - Test impedances
 - Wideband noise
 - Spectrum analyzer
 - Impulse noise

Benefits/Descriptions

- Full-featured TDR with user-selectable pulse widths, length, gain, zoom, filter and Vp
The TDR feature is enabled in the TDR and Pro models
 - Provides graphical representation of events on a pair. Includes 3M™ Dynatel™ Fault Sense analysis of trace results
 - Allows active comparison of two traces
 - Displays difference between two traces
 - Displays the crosstalk from one pair to another
 - Allows comparison of an active trace with a trace stored in memory
 - Displays difference between memory and live trace
 - Displays a history of maximum and minimum values with the live trace
 - Locates light and intermittent faults with optional echo booster
- Wideband noise and Spectrum Analyzer
This feature set is enabled in the Pro models and includes Standard Wideband
 - 100 and 135 Ω
 - Provides metallic and longitudinal noise measurements through wideband standard noise filters
 - Graphical representation of the wideband frequencies present on the pair
 - Counts transient noise events that surpass a settable threshold

2.5 Copper Test Equipment

Electrical Specifications

Functions	Range	Resolution	Accuracy
Voltage (DC)	0 to 99.9 V 100 to 300 V	0.1 V 1 V	1% ± 0.5 V 3%
Voltage (AC) Meter resistance - 100 kΩ or 1 MΩ	0 to 99.9 V 100 to 250 V	0.1 V 1 V	1% ± 0.5 V 3%
Current	0 to 59.9 mA 60 to 110 mA	0.1 mA 0.1 mA	1% ± 0.3 mA 2%
Shunt resistance	430 Ω	Inline Butt	4 Inline 2 Butt
Resistance	0 to 9,999 Ω	1 Ω	1% ± 5 Ω
With CO voltage	0 to 9,999 Ω 10 k to 99.9 kΩ 100 k to 999 kΩ 1 M to 9.9 MΩ 10 M to 99 MΩ 100 M to 990 MΩ	1 Ω 0.1 kΩ 1 kΩ 10 kΩ 0.1 MΩ 1 MΩ	1% ± 50 Ω 1% 3% 3% 5% 10%
Opens (no noise)	0 to 3,000 ft. (0 to 1,000 m) 3,000 to 10,000 ft. (1 km to 3 km) 10,000 to 50,000 ft. (3 km to 15 km) 50,000 to 100,000 ft. (15 km to 30 km)	1 ft. (1 m) 1 ft. (1 m) 10 ft. (10 m) 100 ft. (100 m)	1% ± 3 ft. (1 m) 3% 5% 10%
Resistance Fault Locator (RFL) Fault range	0 to 20 MΩ	—	—
Resistance to fault (no noise)	0 to 99.99 Ω 100 to 999.9 Ω 1 k to 3 kΩ	RTS 0.01 Ω RTS 0.1 Ω RTS 1.0 Ω	0.1% of RTS ± 0.01 Ω1 0.2% of RTS ± 0.01 Ω1 1.0% of RTS ± 0.01 Ω1
Loop resistance	0 to 99.9 Ω 100 to 999.9 Ω 1,000 to 7,000 Ω	0.01 Ω 0.1 Ω 1 Ω	0.1% ± 0.01 Ω 0.2% ± 0.01 Ω 1.0% ± 0.01 Ω
Resistance difference	0 to 99.99 Ω	0.01 Ω	1% of loop resistance ± 0.01 Ω
Tone output ID tone	200 to 1,000 Hz, fixed level (approximately 8 volt peak to peak)	—	±1 Hz
Precision tone- 600 Ω Zout	200 to 9,999 Hz, -20 to +1 dBm 10 k to 19.99 kHz, -20 to +1 dBm	1 Hz, 0.1 dB 1 Hz, 0.1 dB	1% Hz, 0.2 dB 2% Hz, 1 dB
Ringers	0.0 to 4.0 ringer 0 to 2,000 nF	0.1 ringer 10 nF	
Load coil count	0 to 5	1	±1 load coil
Ground resistance	5 to 500 Ω	1 Ω	1% ± 1 Ω
Ohms/distance calculator	0 to 9,999 Ω	0.01 Ω	—

¹Note: All resistance to fault measurement accuracies have an added factor of $[(2 \times 10^{-8}) \times R_f \text{ ohms}]$ (R_f =fault resistance in ohms)

2. Solutions for Outside Plant

2.5 Copper Test Equipment

Electrical Specifications

Functions	Range	Resolution	Accuracy
Loss (and frequency) With 600 Ω Zin	-40 to +10 dBm, 200 to 3,000 Hz -40 to +10 dBm, 3,000 to 9,995 Hz -40 to +10 dBm, 10 k to 19.9 kHz	0.1 dB, 1 Hz 0.1 dB, 10 Hz 1 dB, 10 Hz	± 0.5 dB, 2 Hz ± 0.5 dB, 10 Hz ± 1 dB, 20 Hz
Noise metallic 600 Ω Zin C Message and Psophometric filters	0 to 50 dBmC (-90 to -40 dBmOp)	1 dB	± 2 dB
Noise to ground 600 Ω Zin	40 to 100 dBmC (-50 to 10 dBmOp)	1 dB	± 2 dB
Longitudinal balance	0 to 85 dB	1 dB	± 2 dB
Dial mode	DTMF, pulse	—	—
Caller ID (U.S. and Canada only)	Date, time, number, name	—	—
Carrier level	-4 to -32 dBm	1 dBm	± 2 dBm
TDR			
Length	100 ft, 200 ft, 500 ft, 1,000 ft, 2,000 ft, 5,000 ft, 10,000 ft, 20,000 ft, 30,000 ft (30 m, 60 m, 150 m, 300 m, 600 m, 1.5 km, 3 km, 6 km, 10 km)	1 ft. (1 m)	0.3% range
Pulse width	5 nS, 34 nS, 235 nS, 1600 nS		
Velocity input	0.50 to 0.99 (75 to 150 m/ μ s)	—	—
Modes	Single trace, dual trace, differential, memory, crosstalk, peak, memory differential, live differential (optional)	—	—
Wideband specifications without SA option			
Wideband tone output 100,135 Ω Zout	0 dBm, 20 kHz to 2.2 MHz	1 kHz	± 1 dB
Wideband Loss 100, 135 Ω Zin	-85 to +5 dBm, 20 kHz to 2.2 MHz	0.1 dB, 100 Hz	± 1 dB, 1% Hz
Wideband specifications with SA option			
Wideband tone output 100, 135 Ω Zout	0 dBm, 20 kHz to 2.2 MHz	1 dB, 1 kHz	+/-1 dB, $\pm 0.1\%$ Hz
Wideband Loss 100, 135 Ω Zin	-85 to +5 dBm, 20 kHz to 2.2 MHz	0.1 dB, 100 Hz	± 1 dB, 1% Hz
100, 135 Ω Zin dynamic range	10 kHz to 2.2 MHz -90 dBm to +10 dBm	1% of span	1%
Wideband noise metallic 100, 135 Ω Zin	E filter 10-90 dBm F filter 20-90 dBm G-2, filter 30-90 dBm	1 dB 1 dB 1 dB	± 2 dBm ± 2 dBm ± 2 dBm
Impulse noise counting E, F, G & G2 filters Counting interval threshold	1 to 60 minutes 0 to 90 dbm	1 minute 1 dB	$\pm 5\%$ ± 1 dB

2.5 Copper Test Equipment

General Specifications

Feature	Performance/Capability
Drop test	Survives 3 ft. (1 m) drop onto concrete (or 5 ft. drop onto concrete with soft case) using ASTM D4169 assurance level I method 5276
Vibration	Meets Mil-Std 810F method 514.5
Water, dust and chemical proof	Meets IP65 per IEC 529 (1989) for rain and dust Immersion test IP67 0.15 m deep
Emissions	Meets FCC part 15, class A: Digital Devices for the US, and EN55022 (radiated emissions) for Europe
Built to ISO9001/2000 certification for manufacturing facilities and TL 9000 compliant	
Built to ANSI/IPC A610-C manufacturing standards	
Languages supported	English, Spanish, French Canadian, German, Italian, Danish, Polish, Finnish, Russian, Turkish, Japanese, Taiwanese, Korean, and Chinese
Units	Feet or metre, Fahrenheit or Celsius, dBmC or dBmOp, m/uS or Vp
Battery	Rechargeable battery pack or alkaline cell holder 9 hours typical use (50% on/off measuring voltage)
Display	4.1" x 3.1" (104 x 79 mm), 320 x 240 pixel resolution, high visibility in bright sunlight due to 3M Vikuiti film technology

Note: Routine lab calibration is not recommended or required

Environmental Specifications

Feature	Specifications
Operating temperature	0° to 140°F (-18 to 60°C)
Storage temperature	-40° to 165°F (-40 to 75°C)
Moisture	Meets or exceeds IP64, IP67

Physical Specifications

	Size (H X W X D) In. (Cm)	Weight (Including Batteries)
965AMS (includes ADSL2+ module)	11.5 x 5.75 x 3.25 (29.2 x 14.6 x 8.3)	3.5 lbs. (1.59 kg)
965AMS (includes All-in-one VDSL2 module)	11.5 x 5.75 x 3.625 (29.2 x 14.6 x 9.2)	3.8 lbs. (1.72 kg)

2.5 Copper Test Equipment

Available Accessories²

	Description
Test leads	Five 5-ft (1.5 m) test leads with 2 mm gold-plated banana plugs on one end and chrome-plated alligator clips on other end (black/red, blue/yellow, green) Lead styles include bed of nails, no nails, spike and Canadian test leads
European test leads	Five 5-ft (1.5 m) test leads with 2 mm gold-plated banana plugs one end and 4-mm gold-plated banana plugs on other end (black/red, blue/yellow, green)
RFL strap	1.5 ft. (0.5 m) with alligator clips on ends
User's guide	User's guide on CD & DVD
Vehicle charger	Power adapter for vehicle
Soft case	Full soft case available
Alkaline battery holder	Six AA alkalines can provide power
Self-test board	Verify system performance
Communication cables	USB, serial adapter cables
AC charger	100-250 VAC (50/60 Hz) input, 12 VDC (1 A) output power cord with IEC socket, US cord included

²Not all accessories included in all product configurations

Configuration³

Model Name Features:	965AMS Lite	965AMS	965AMS w/TDR	965AMS w/TDR, ADSL2+	965AMS Pro (2 MHz)	965AMS Pro (2 MHz) w/ADSL2+	965AMS Pro (30 MHz) w/VDSL2
VOM, RFL, POTS	•	•	•	•	•	•	•
TDR	Optional	Optional	•	•	•	•	•
Wideband loss/tone		•	•	•	•	•	•
Wideband test suite					•	•	•
Modem Module ADSL2+				•		•	
All-in-one Modem Module VDSL2							•

³Voiceband Spectrum Analyzer and Expert Pair Test not standard on 965 AMS Lite

Kit Components

Model	Description
965AMS Lite	965AMS base unit, bag, blue, yellow, green, red and black test leads, DVD user's guide, alkaline battery holder, NiMH battery pack, 110/220 VAC adapter, certificate of calibration, warranty card and USB cable
All other 965AMS Models	965AMS base unit, bag, blue, yellow, green, red and black test leads. Conductor strap, NiMH battery pack (packed in unit), alkaline battery holder, wire gauge, self test circuit board and chain bead, 110/220 V AC adapter, certificate of calibration, vehicle power adapter, CD/DVD user's guide, warranty card, quick reference card, USB cable, and Ethernet cable (with modem module)

2.5 Copper Test Equipment

Ordering Information

	Ref. No.
965AMS - LITE / BON	80-6113-31507
965AMS - LITE / BANANA	80-6113-3151-5
965AMS - TDR / BON	80-6113-2146-6
965AMS - TDR / SA / BON	80-6113-2145-8
965AMS - TDR / SA / BANANA	80-6113-2097-1
965AMS - TDR / SA30 / BON	80-6113-3000-4
965AMS - TDR / SA30 / BANANA	80-6113-2999-8
965AMS - TDR / BON / ADSL2+	80-6113-2149-0
965AMS - TDR / SA / ADSL2+ / BON	80-6113-2148-2
965AMS - TDR / SA / ADSL2+ / BANANA	80-6113-2098-9
965AMS - TDR / SA / VDSL2 / BON	80-6113-2506-1
965AMS - TDR / SA / VDSL2 / BANANA	80-6113-2672-1
965AMS - TDR / SA30 / VDSL2 / BON	80-6113-2971-7
965AMS - TDR / SA30 / VDSL2 / BANANA	80-6113-2972-5
965AMS - TDR / SA / BON with FED II	80-6113-1500-5
965AMS - TDR / SA / ADSL2+ / BON with FED II	80-6113-1611-0
965AMS - TDR / SA30 / BON with FED III	80-6113-3011-1
965AMS - TDR / SA30 / BANANA with FED III	80-6113-3012-9
965AMS - TDR / SA30 / VDSL2 / BON with FED III	80-6113-3005-3
965AMS - TDR / SA30 / VDSL2 / BANANA with FED III	80-6113-3006-1
ADSL2+ Service Interface Module for 965AMS	80-6113-1661-5
VDSL2 Service Interface Module for 965AMS	80-6113-2668-9

965AMS Spare Parts:

Test Leads black/red 1,5m 2mm Alligator BON	78-8140-0371-7
Test Leads black/red 1,5m 4mm Banana	78-8140-0388-1
Test Leads blue/yel 1,5m 2mm Alligator BON	78-8140-0370-9
Test Leads blue/yel 1,5m 4mm Banana	78-8140-0389-9
Test Leads green 1,5m 2mm Alligator BON	78-8140-0372-5
Test Leads green 1,5m 4mm Banana	78-8140-0390-7
1185 BATTERY PACK NIMH FOR 965AMS SERIES	80-6113-1618-5
186 ADAPTOR-CHARGER FOR 965AMS 110/220V AC	80-6113-1620-1
1188 VEHICLE POWER ADAPTOR FOR 965AMS/950ADSL2+	80-6113-1622-7
1197 FULL SOFT CASE FOR 965AMS SERIES	CB-0407-0281-6

2.5 Copper Test Equipment

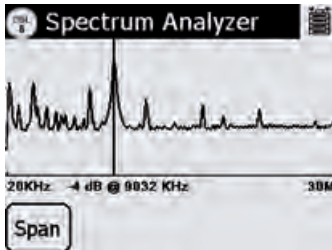

30MHz spectrum analyzer provides wideband parametric testing

3M Dynatel Advanced Modular System 965AMS/SA30

Summary

The 965AMS/SA30 test set is an enhanced version of the 965AMS/SA unit that includes new circuitry to provide extended DSL and VDSL2-specific measurement capabilities. DSL services supported include ISDN/IDSL, HDSL, HDSL2/4, ADSL, ADSL2/2+ and VDSL2. The product conforms with standardized test specifications per IEEE 743-1995 (or newer documents).

Test Range and Accuracy

Wideband Loss

Frequency Range	20kHz to 30MHz
Measurement Level ⁽¹⁾	-75 to +10dBm
Resolution/Accuracy	0.1dB resolution/ 1dB accuracy
Impedance	75/100/135 ohm selectable

Wideband Frequency

Frequency Detect Range	20kHz to 30MHz
Frequency Detect Level ⁽¹⁾	-75 to +10dBm
Resolution/Accuracy	3 digit resolution, accuracy +/-1%

Wideband Signal Generator

Frequency Range	20kHz to 30MHz
Output Level	0dBm
Output Level Accuracy	±1 dB
Output Impedance	75/100/135 ohm selectable

Wideband Noise

Modes	Metallic and Longitudinal ⁽²⁾
Frequency Range	1kHz to 30MHz (depending on filter)
Metallic Level Range	+10/+20/+30/+33/+40/+42/+43/+46dBm to +90dBm per filter spec (limited to 1V peak metallic voltage at Tip and Ring)
Longitudinal Level Range	+40/+50/+60/+63/+70/+72/+73/+76dBm to +120dBm per filter spec (limited to 10V peak longitudinal voltage)
Resolution/Accuracy	1dB resolution/2dB accuracy
Impedance	75/100/135 ohms metallic; longitudinal 10Kohms

¹ -70 for H4 Filter

2.5 Copper Test Equipment

Test Range and Accuracy

Noise Weighting Filters

E Filter (ISDN/IDSL)	1kHz - 50kHz
F Filter (HDSL)	4.9kHz - 245kHz
G Filter (ADSL/ADSL2)	20kHz - 1.1MHz
G2 Filter (ADSL2+)	20kHz - 2.2MHz
H1 Filter (VDSL2)	20kHz/138kHz - 8.8MHz (Profile 8 with selectable USO support)
H2 Filter (VDSL2)	20kHz/138kHz - 12MHz (Profile 12 with selectable USO support)
H3 Filter (VDSL2)	20kHz/138kHz - 17.6MHz (Profile 17 with selectable USO support)
H4 Filter (VDSL2)	20kHz/138kHz - 30MHz (Profile 30 with selectable USO support)

Spectrum Analysis

Frequency Spans	125kHz, 250kHz, 500kHz, 1MHz, 2MHz, 8MHz, 16MHz, 32MHz
Frequency Range	20kHz to 30MHz
Measurement Level ⁽³⁾	-80 to +10dBm
Frequency Resolution	1% of span
Input Impedance	100/135 ohm or Hi-Z

Wideband Impulse Noise

Modes	Metallic and Longitudinal ⁽²⁾
Threshold	Filter minimum to 100dBm
Filters	E, F1, G, G2, H1-H4
Number of Thresholds	Three
Blanking Duration	Adjustable
Counting Interval	1-60 minutes
Count Capacity	65,536

² Longitudinal limited to 2.2 MHz (filter E-G2)

³ Lowest useable level depends on frequency span.

2.5 Copper Test Equipment

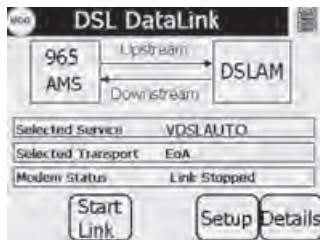

VDSL AUTO mode automatically connects at the highest possible connect rate/service type (i.e. VDSL2, VDSL, ADSL2+)



3M™ Dynatel™ All-in-one Modem Module VDSL2



Browse

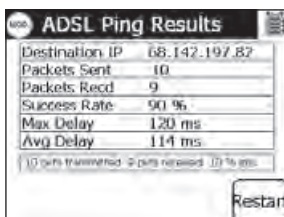

Ping

3M Dynatel All-in-one Modem Module VDSL2

Summary

The All-in-one Modem Module VDSL2 is a self-contained unit that attaches to the 3M™ Dynatel™ Advanced Modular System 965AMS at the module position on the back of the unit. Power is supplied by the 965AMS. This module is designed to provide testing of xDSL services. It allows the technician to attach to the copper service pair bearing a DSL circuit via 965AMS the red and black test leads. The technician can then connect to the DSLAM at the CO or field cabinet, measure and display connect statistics, link to the server, ping through the server to an IP destination, or browse the Internet.

Functionality

The modem module supports the following DSL service types:

- ANSI T1.413 Issue 2
- ADSL G.dmt G.992.1/2 Annex A
- ADSL2 G.992.3/4 Annex A
- ADSL2+ G.992.5 Annex A, B, L and M
- VDSL1 G.993.1
- VDSL2 G.993.2 plan 997, 998 supports all eight profiles: 8a, 8b, 8c, 8d, 12a, 12b, 17a and 30a

The modem module supports the following WAN internetworking protocols:

- Point-to-point protocol over Ethernet
- Point-to-point protocol over ATM

Connect Statistics

The 3M™ Dynatel™ All-in-one Modem Module VDSL2 provides the following parametric data to the 3M™ Dynatel™ Advanced Modular System 965AMS application:

- Modem status (Showtime, initialization)
- Transmission system (e.g. G.992.5)
- Vendor ID information
- Downstream and Upstream maximum attainable rates
- Downstream and Upstream noise margin
- Downstream and Upstream total aggregate transmit power

- Bridge mode RFC1483
- Dynamic host configuration protocol (DHCP) client

The modem module supports the following functions:

- Connect with a DSLAM
- Link with the server
- Ping to/through the server to an IP destination
- Internet browsing
- Substitute as a CPE DSL modem by operating in a 'thru-mode' from the DSL port to the module Ethernet port
- Support DSL data transport services such as web browsing or ftp transfers
- Support ADSL2+ non-zero INP settings at full data rate
- Validate Ethernet port connectivity and data rate

- Downstream and Upstream capacity
- Bits per tone for each subcarrier
- SNR per tone for each subcarrier
- Forward Error Correction Count (FEC)
- Cyclic Redundancy Check (CRC) error count
- Header Error Control (HEC) violation
- Loss of Signal (LOS)
- Loss of Frame (LOF)
- Loss of Power (LPR)
- Downstream and Upstream transmit power
- Downstream and Upstream line attenuation
- Downstream and Upstream actual data rate
- Downstream and Upstream interleaving delay
- Downstream and Upstream interleaving depth

Ethernet Functions

10 Base T/100 Base T Selectable

Ping via Ethernet

Browse via Ethernet

Ping via Customer Premise xDSL Connection

Browse via Customer Premise xDSL Connection

Specifications

Size	6.0" H x 5.5" W x 1.5" D
Weight	0.86 lb.
Operating Temperatures	-20°C to +60°C (operational time is limited at higher temperatures)
Storage Temperature	-40°C to +85°C
Humidity	0 to 90% non-condensing
Rain & Dust	IP64 (attached to 965AMS)
Drop Test	Survives 3 ft. (1 m) drop onto concrete, (survives 5 ft. drop onto concrete with soft case) using ASTM D4169 assurance level I method 5276
FCC	CFR 47 Part 15 Class A
CE	EN 55022 Class A, EN61000-4-2, EN1000-4-3

2.5 Copper Test Equipment



3M 1342 Far End Device II

Remote controlled far end testing assistance

The perfect companion to the 3M Dynatel 965AMS / DSP Subscriber Loop Analyser, the 3M 1342 Far End Device II (FEDII) provides remote controlled far end testing assistance during subscriber loop testing. Designed to enhance technician productivity, the FEDII connects to the far end on a cable pair to enable diagnostic testing to be performed from the near end controlled by the 3M Dynatel 965AMS / DSP.

Support of "auto" test function on Dynatel 965DSP, 965DSP-SA and 965DSP-B to facilitate loss measurement:

- Insertion loss to 1.2 MHz
- Slope
- Loop resistance
- Resistance balance

One technician, one test set: Pair Qualification

With a 3M Far End Device II (FEDII), one technician with a 3M Dynatel 965AMS / DSP Subscriber Loop Analyser can perform end-to-end testing of metallic cable pairs. Commanded by the Dynatel 965AMS / DSP, the FEDII provides trace tone to verify cable pair connection, supports the 965AMS / DSP auto testing feature and qualifies loop performance up to 1.2 MHz (ADSL). Controlled by DTMF signaling from the 965AMS / DSP, the FEDII can be commanded to remotely power-up, respond to test signaling, transmit tone on technician-selected conductors, or close relays to short the pairs in any combination. The unit can also be powered-up and

commanded manually. The new FEDII may be connected in series with a working pair or bridged on to the test pair. In addition, the FEDII may be connected to two separate pairs allowing the end users to test two pairs.

Pocket accessory

Housed in a rugged, pocket-sized plastic case within a protective Cordura pouch, the 3M Far End Device features a power on/off LED and a test lead. The FED optimises its replaceable 9V-battery life with an automatic power-down feature.

Specifications

Size	4.7"H X 2.6"W X 0.9"D (11,9 cm X 6,6 cm X 2,3 cm)
Weight	5.6 oz. (159 g) with battery
Operating temperature	0° to +140°F (-18° to +60°C)
Storage temperature	-40° to +165°F (-40° to +75°C)
Battery life	40 hours typical
Battery shelf life	2 months (installed)
Replacement battery	Recommend: Duracell™ MN1604 9V Alkaline or equivalent
Strap resistance	Less than 0.2 ohms
DC input impedance	>100 megohms tip-ring-ground
AC input impedance	~100 kohms in series with 470 pf tip-ring
Voltage rating	250 Vdc, 150 Vac
ID tone frequency	577 Hz and 1004 Hz
ID tone amplitude	8 volts peak to peak; no load typical
Transmitted tones	0 dBm ± 0.5 dBm 400 Hz to 100 kHz 0 dBm ± 1.0 dBm 100 kHz to 1.2 Mhz

Ordering Information

Product Description	Ref. No.
1342 FAR END DEVICE II W/ALLIGATOR CLIPS	80-6111-3261-6
Spare Parts:	
CABLE FEDII RJ45/BON 7 LEAD	78-8130-4382-1
CABLE FEDII RJ45/LONG NOSE ALLIGATOR CLIP 7 LEADS	78-8130-5661-7

2.5 Copper Test Equipment



3M Dynatel Far End Device III

3M Dynatel Far End Device III

Optimized for VDSL2, Outside Plant and Central Office Applications

The 3M Dynatel Far End Device III (FED III) is an accessory device to the 3M Dynatel Advanced Modular System 965AMS family. When used with the Dynatel 965AMS, the FED III helps improve work efficiency by automatically providing tones and terminations at the far-end of a pair under test during pair qualification testing. The 965AMS remotely controls the FED III using DTMF signaling.

The FED III supports the following functions of the 965AMS Autotest feature:

- Loop resistance (shorts tip to ring)
- Resistive balance (shorts tip-ring to ground)
- Longitudinal balance (provides IEEE balance termination)
- Noise (provides quiet termination)
- Single tone and sweep loss (sends loss tones for voiceband and wideband qualification)

The FED III is housed in a rugged Xenoy® plastic case. The user interface is provided by a keypad with five function keys (on/off, battery test, ID tone, two spares) and four LEDs (status and battery level). The FED III is powered by four AA alkaline batteries

(supplied). Three sets of test leads and one ground lead (supplied) plug into seven jack positions on the front of the case and are terminated in heavy-duty alligator clips. Each test lead set is colour-coded for ease of attachment to the appropriate pair under test.

Specifications

Input Keys

“ON/OFF”

Unit can be turned ON/OFF either by this key or remotely by a 965AMS or 3M Dynatel Subscriber Loop Analyzer 965DSP

Unit automatically turns off at programmed time from last key push or command (automatic OFF time can be adjusted remotely by AMS)

“BATT TEST”

Provides a battery test that indicates battery level on keypad LED's

“ID TONE” & audible continuity test

ID tone on pair 1
T-R resistance on pair 1 < ~1 Kohms

“F1” key for future options

“F2” key for future options

Visual indicators

Status LED: blinks indicating activation

Batt '1' LED on: battery > 75%

Batt '1/2' LED on: battery > 50%

Batt '0' LED on: battery > 25%

Batt '0' LED flashing: battery < 25%

Auto power down time

30 minutes (AMS can override & turn FED III unit ON/OFF at any time)

Continuity resistance

Buzzer tone if resistance between Pair 1 leads is less than ~1 Kohms (during ID tone)

Control commands

DTMF signaling from 965AMS or 965DSP

Software upgrade

USB mini-B receptacle accessible from sealed battery compartment - Standard USB cable (supplied)

2.5 Copper Test Equipment

Electrical Specifications

Tone output	400 Hz to 100 kHz 100 kHz to 2.2 MHz 2.2 MHz to 30 MHz Low power level is -20 dBm nominal	0 dBm or -20 dBm / ± 0.5 dB 0 dBm or -20 dBm / ± 1.0 dB -5 dBm / ± 1.5 dB
Tone output impedance (controlled by AMS)	400 Hz to 20 kHz 20 kHz to 400 kHz 20 kHz to 30 MHz 20 kHz to 30 MHz	600 Ω 135 Ω 100 Ω 75 Ω
Longitudinal balance termination	IEEE 455-1985	
Strap resistance	< 0.2 Ω (internal to FED III)	
DC input impedance	>100 M Ω Tip-Ring-Gnd	
AC input impedance	100 k Ω in series with 470 pF (cadence wakeup circuit)	
Voltage rating	250 VDC, 150 VAC (Tip-Ring-Gnd)	
ID tone frequency	Alternating 577 Hz and 1004 Hz tone interrupted @ 20 Hz applied Tip to Ring Source impedance 600 ohms (sine wave)	
ID tone amplitude	10 V pk-pk typical	

Battery

Battery type	4 AA alkaline cells (type E91 or equivalent)
Battery life	~70 hrs @ 40 mA avg load ~140 hrs @ 20 mA avg load
Battery shelf life	>12 months with unit OFF typical

Physical/Environment/Compliance

Dimensions	6.8" L x 4.6" W x 1.4" Thick
Weight	15.75 oz (with batteries)
Operating temperature	-18°C to 60°C
Storage temperature	-40°C to +75°C
Water, dustproof	Meets IP65 per IEC 529(1989) for rain and dust Immersion test IP67 0.15m deep
Drop test	Survives 5 ft. drop onto concrete with soft case using ASTM D4169 assurance level 1 method 5276
Vibration	Meets Mil 810F method 514.5
Emissions	FCC Part 15 Class A, EN55022
ESD	EN61000-4-2, EN61000-4-3

2.5 Copper Test Equipment

Accessories

Soft case	Top plastic hook provides for hanging in customer applications Access to battery compartment for battery change Provides storage for instructions and test leads
Test leads	3 Red/Black grouped pairs (BLUE, RED, YEL) each 21" long Blue group is Pair 1, Yellow group is CO Pair, Red group is Pair 2 GREEN lead is 32" long
Operators manual	
USB cable	USB A Plug – Mini USB B Plug

Ordering Information

Product Description	Ref. No.
> 1193 FAR END DEVICE III with BON test leads	80-6113-2640-8
> 1196 FAR END DEVICE III with Banana jack test leads	80-6113-2643-2
Spare Parts:	
> ROHS-LEAD, TEST, RED/BLK/GRN/BLU BAND, 2 MM ALLIGATOR, BON	78-8140-1583-6
> ROHS-LEAD, TEST, RED/BLK/YEL BAND, 2 MM ALLIGATOR, BON	78-8140-1587-7
> ROHS-LEAD, TEST, RED/BLK/GRN/BLU BAND, 4 MM BANANA PLUG, FED III	78-8140-1588-5
> ROHS-LEAD, TEST, RED/BLK/YEL BAND, 4 MM BANANA PLUG, FED III	78-8140-1589-3
> ROHS-LEAD, TEST, RED/BLK/RED BAND, 4 MM BANANA PLUG, FED III	78-8140-1648-7

2.5 Copper Test Equipment



Test set in soft carry case.

3M Dynatel Qualification Test Set 950ADSL2 Plus

The heat is on to provide high-speed Internet access and enhanced broadband services over existing copper networks. 3M's next generation Dynatel Qualification Test Set 950ADSL2 Plus has all the right features to ensure the successful installation and maintenance of ADSL2+ service.



The 3M Dynatel Qualification Test Set 950ADSL2 Plus is a cost-effective solution ideal for technicians providing both POTS testing and verification of ADSL2+ modem connectivity.

Rugged, reliable design

The Dynatel test sets are housed in a light-weight, hand-held case designed for ease-of-handling and portability. Each unit weighs less than 2.5 pounds with the rechargeable battery pack included. The display clearly provides test results and measurements including bin graphs and data rates.

Keypad Functions

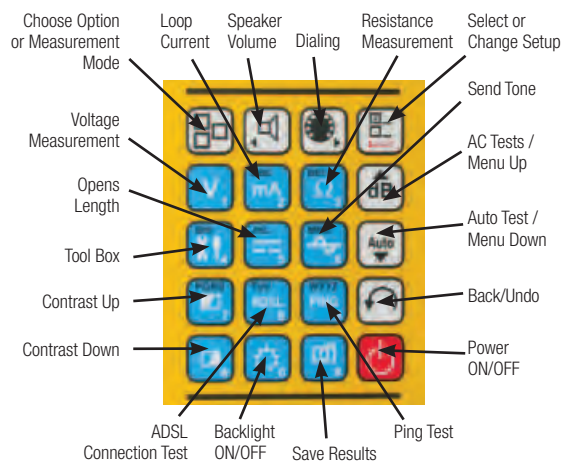

Sample Screen



2.5 Copper Test Equipment

Pots and ADSL Tests

The Dynatel Qualification Test Set 950ADSL2 Plus conducts multiple metallic tests independently or as part of the Autotest function. Tests include CO and foreign voltage, insulation and loop resistance, longitudinal balance and loss & noise. Autotest results can be saved and uploaded for record storage and later analysis. The tester can also generate tones up to 2.2MHz for loss measurements.

ADSL2+ active testing include performance measurements including data rate up/down, max rate, attenuation etc., as well as error measurements such as FEC, CRC and HEC with bin graph capture to analyze data transfer performance. The 950ADSL2 Plus can also ping to an ISP to measure response time. In addition, ADSL2+ test results can be saved and uploaded for record storage or later analysis.

Product Features

Tests Performed

- Volts – AC and DC
- Loop Current
- Resistance Test
- Soak Test
- Ground Resistance
- Opens
- Loss and Noise
- Longitudinal Balance
- Pulse and DTMF Dialing
- Load Coils
- POTS Autotest
- Precision Tones to 2.2Mhz
- ADSL2+/ADSL2/ADSL Connectivity
- Ping Testing

Features

- Backlit LCD
- Water resistant attachment for test leads and DC charger
- Rechargeable NiMH battery
- Serial upload to PC
- Storage for 100 ADSL2+ results
- Storage for 10 POTS results

General Specifications

Size	60 mm high x 100 mm wide x 200 mm long
Weight	Less than 1.5 lb. with battery
Battery	Ni-MH: 2100 mAh – shrink wrap pack, user replaceable through access door on bottom of unit
Battery life	8 hours standby (backlight off) + 20 full ADSL2+ qualification tests of 2 minute duration Separate charger / AC/DC adapter connects to the unit through external power jack Auto shutdown after 5 minutes with no activity, except during charging
Display	64 x 128 pixel, 57 mm x 31 mm viewing area with LED backlight
Test leads	Red, black and green leads. 1.5 m long. Connected to unit via standard jacks
Breakdown voltage	360 VDC, 250 VAC
Operating temperature	-18°C to 60°C except for ADSL2+ and Battery Charger Functions 0°C to 60°C ADSL Functions 0°C to 50°C battery charger operation
Humidity	0 to 95% non-condensing
Shock	Will survive 3 drops from 1 m
Regulatory	CE/FCC per: CISPR 11:2003 / EN55011:2003, Class A, Group 1 FCC CFR 47, Part 15, Subpart B – Class A EN61326:1997+A1:1998+A2:2001 (IEC 61326:2002)
Dialing	DTMF or Pulse Dialing – 10 number storage
ADSL2+ Test Storage	100 sets of results, each identified with an alpha numeric label Stored results can be viewed in the test set
POTS test storage	10 sets of results, each identified with a 10-digit numeric identifier Stored results can be viewed in the test set
POTS autotest	Autotest will run the following tests: V (T,R,Gnd), mA, Ground Resistance, Ohms (T,R,Gnd), Opens (T,R,Gnd), Load Coil Count, Noise, PI, LB and Loss (up to 10 voiceband frequencies)
Languages	English, French or alternative 2nd language subject to availability
Serial port	Adapter cable connected to the test leads can be used for connecting the unit to a PC The serial connection supports the following: <ul style="list-style-type: none"> • Upload of test results to the PC • Remote configuration of ADSL and Ping parameters from a PC • Field software updates

2.5 Copper Test Equipment

Pots Measurement Specifications

Function	Range	Resolution	Accuracy	Test Leads
AC voltage	0 to 250 VAC (input resistance = 1M Ohm \pm 5%)	\pm 1 V	\pm 2%	R-T, R-G, T-G
DC voltage	0 to 250 VDC (input resistance = 1M Ohm \pm 5%)	\pm 1 V	\pm 2%	R-T, R-G, T-G
Loop Current (DC)	0 to \pm 110 mA	1 mA	\pm 2mA	R-T (Impedance= 430 Ω)
Resistance	0 ohm to 999 ohms 1K ohm to 9.9K 10K ohms to 99.9K ohms 100K ohms to 999K ohms 1M ohm to 9.9M ohms 10M ohms to 30M ohms Voltage compensation for foreign voltage conditions	1 ohm ohms 10 ohms 100 ohm 1K ohm 100K ohms 1M ohm	\pm 5 ohm \pm 3% \pm 3% \pm 3% \pm 3% \pm 3% \pm 10%	R-T, R-G, T-G
Loop loss	-50 to +10 dBm 200 to 5000 Hz	1 dB	\pm 1 dB	R-T (Impedance = 600 Ω)
Frequency during loss, single frequency only and levels greater than -45 dBm	200 to 5,000 Hz	1 Hz	\pm 3 Hz \pm 0.2%	R-T
Noise metallic with C-message weighting**	0 to 60 dBrc	1 dB	\pm 2 dB	R-T (Impedance = 600 Ω)
Noise to ground with C-message weighting**	40 to 100 dBrc	1 dB	\pm 2 dB	R & T-G (Zin = 100KW)

Note: Available only with a C-Message filter, for Psophometric version contact Communication Markets Division, 3M Telecommunications

Opens	0 to 9,999 ft. 10,000 to 99,999 ft (0 to 9,999 m) (10,000 to 30,000 m)	1 ft. 100 ft (1 m) (100 m)	\pm 20 ft. \pm 5% +/- 5% (\pm 6m, \pm 5%) (+/- 5%)	Ring, Tip, Mutual
Longitudinal balance	0 to 65 dB	1 dB	\pm 2 dB	T, R-G
Ground resistance	0 to 50 Ω	1 Ω	\pm 3 Ω	
Load coils	Count 0, 1, 2, 3, 4 or >4 coils		+/- 1 coil	

Note: First load must be >3000' from unit and 3000' of cable must extend beyond the last load coil for an accurate count

Precision tone	Frequency: 404, 1004, 2804 (preset) (Source impedance = 600 ohms +/- 5%)		Amplitude 0 \pm 0.5 dBm	R-T
	Frequency: 8000 Hz – 2.2Mhz (user settable) +/- 10% Source impedance = 100 ohms +/- 5% 577 Hz intermittent trace tone		Amplitude 0 \pm 0.5 dBm Amplitude 5V P-P	R-T

Notes: * Percent of reading

** C-message specification has additional frequency dependent tolerance. Refer to "Subscriber Loop Transmission Test Set Specification", Bell System PUB 55020, January 1982.

2.5 Copper Test Equipment

ADSL/ADSL2+ Measurement Specifications

ADSL/ADSL2+ Standards	T1.413 i2 (ANSI) G.992.2 (G.LITE) G.992.1 (G.DMT) G.992.3 (G.DMT.bis/ADSL2) G.992.5 (ADSL2plus) Support for Annexes A, B, and L Line impedance 100 ohms nominal
------------------------------	---

Function	Measurement
ADSL2+ Status (up/down)	Fast rate Interleaved rate Maximum attainable bit rate Power Margin Attenuation Capacity
ADSL2+ Information (up/down)	FEC (forward error correction count) CRC Error count HEC ATM Header Errors count SEF Severe Errors Frame count LOS Loss of signal count
	Bin Graph
ADSL2+ Alarms	LOS: Loss of Signal > 127 LOF: SEF > 127 LCD: NCD or LCD > 127

Pots and ADSL Tests

IP address assignment	DHCP per RFC 2131 IPCP per RFC 1332
Point-to-Point Protocol	PPP over ATM (PPPoA) PPP over Ethernet (PPPoE)
Authentication	PAP CHAP
Ping	Connection time +/- 10 mS

2.5 Copper Test Equipment

Ordering Information

Product Description	Ref. No.
950E-ADSL2+ QUALIFICATION TEST SET BON	80-6113-2922-0
950ADSL2+, P-FLITER, BON LEADS,CAR/ADP, SPANISH	CE-1007-2309-3
Spare Parts:	
1188 VEHICLE POWER ADAPTOR FOR 965AMS/950ADSL2+	80-6113-1622-7
1120 RECHARGEABLE NIMH BATTERY PACK FOR 949/950 ADSL	80-6113-2929-5
950ADSL2+ 12V DC CHARGER	CE-1007-0726-0
950ADSL2+ serial cable	CE-1007-0725-2
1143 test lead green 1,5m BON	80-6108-6437-5
1144 test lead black/red 1,5m BON	80-6108-6435-9
1119 Soft carrying case 949/950	80-6113-2928-7

Accessories

Subscriber Loop Tester/Analyser for 3M™ Dynatel™ 965DSP

Product	Pkg.	Min. Order	Ref. No.
> Cigarette lighter adapter accessory (not pictured)	1/cs.	1 each	051138-57744
> Alkaline battery holder	1/cs.	1 each	051138-57685
> 110/220 Vac adapter	1/cs.	1 each	051138-57606
> Soft case (not pictured)	1/cs.	1 each	051138-57605
> Nickel metal hydride battery pack,	1/cs.	1 each	051138-57646
> Black/red test lead, alligator, bed of nails (not pictured)	1/cs.	1 each	051138-57648
> Black/red test lead, banana plugs (not pictured)	1/cs.	1 each	051138-57608
> Blue/yellow test lead, alligator, bed of nails (not pictured)	1/cs.	1 each	051138-57649
> Blue/yellow test lead, banana plugs (not pictured)	1/cs.	1 each	051138-57610
> Ground Strap, alligator	1/cs.	1 each	051138-58529
> Ground Strap, banana (not pictured)	1/cs.	1 each	051138-58532
> Green test lead, alligator, bed-of-nails	1/cs.	1 each	051138-57650
> Green test lead, banana plugs (not pictured)	1/cs.	1 each	051138-57612

