



Peripheral Devices

T-branch Taps and Terminal-block Terminator

T-branch Taps Create One or Three Branch Lines

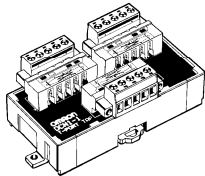
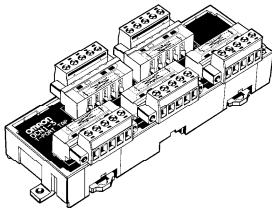
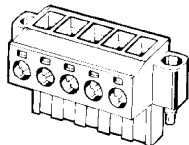
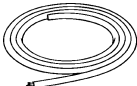

Ordering Information

Product		Appearance	Model	Specification
T-branch Tap for 1 branch line			DCN1-1C	Provided with 3 connectors, standard terminating resistor
T-branch Tap for 2 branch lines			DCN1-3C	Provided with 5 connectors, standard terminating resistor
Connector			XW4B-05C1-H1-D	---
DeviceNet Cables	Thin cables		DCA1-5C10	Outer diameter: 7.00 mm Length: 100 m
	Thick cables		DCA2-5C10	Outer diameter: 11.6 mm Length: 100 m
Terminal-block Terminator			DRS1-T	Resistance of 121 Ω

■ Connectors for DCN1-□C

Model	Comments	Manufacturer
MSTB2.5/5-ST-5.08-AU	For node connection	Phoenix Contact Corporation
MSTBP2.5/5-STF-5.08-AB AU SO	For T-branch Tap connection (with screws to secure the connector)	Phoenix Contact Corporation

Specifications

■ Ratings/Characteristics

Rated current	Between main lines: 8 A (power supply line) and 2 A (signal line) Between main and branch lines: 3 A (power supply line) and 1 A (signal line)
Insulation resistance	100 MΩ min. (at 500 VDC)
Dielectric strength	500 VAC for 1 min, leakage current: 1 mA max.
Ambient temperature	Operating: 0°C to 55°C

■ Materials

Item	Component	Materials
Unit	Main and Expansion Units	PBT resin with glass (UL14V-0)/gray
	DIN track lock	POM resin/yellow
Terminal block connector (see note)	Housing	PA66 resin (UL94V-0)/gray
	Contact	Phosphor bronze coated with gold
PCB		Glass epoxy resin

Note: The DCD1-1C is a product of Phoenix Contact.

Dimensions

Note: All units are in millimeters unless otherwise indicated.

DCN1-1 (With No Branching Connector)
DCN1-1C (With Three Branching Connectors)

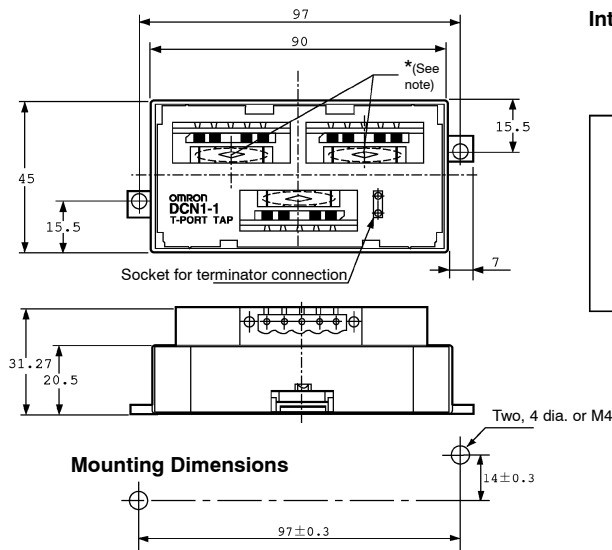
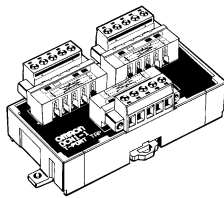

Internal Circuit

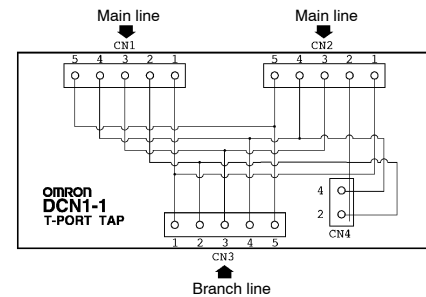

Terminal no.	
1	V-
2	CAN-L
3	DRAIN
4	CAN-H
5	V+

Note: When connecting a branch line to the main line, connect the main line to the connector marked with an asterisk because the resistance between the asterisked portion is minimal.

DCN1-3 (With No Branching Connector)
DCN1-3C (With Five Branching Connectors)

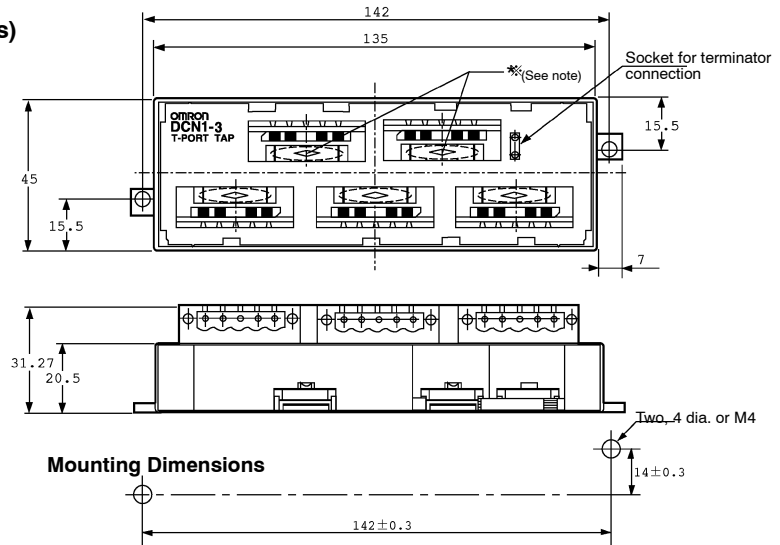
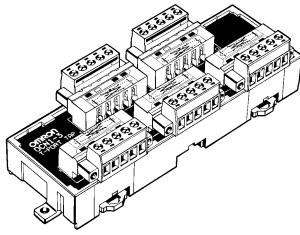

Internal Circuit

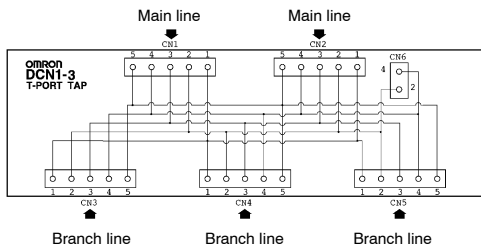

Terminal no.	
1	V-
2	CAN-L
3	DRAIN
4	CAN-H
5	V+

Note: When connecting a branch line to the main line, connect the main line to the connector marked with an asterisk because the resistance between the asterisked portion is minimal.

XW4B-05C1-H1-D (Connector)

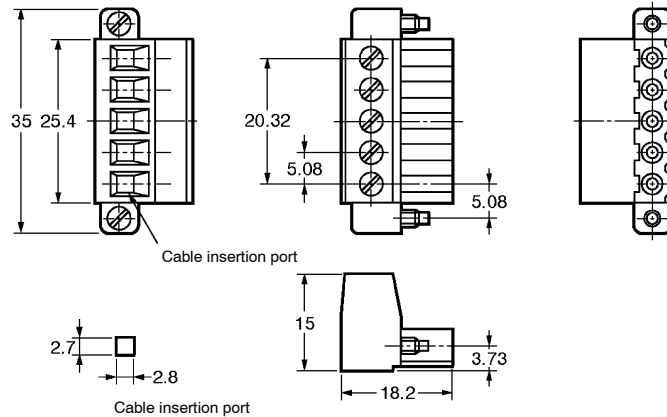
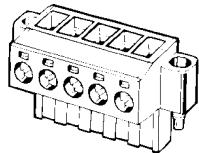

DRS1-T Terminal-block Terminator

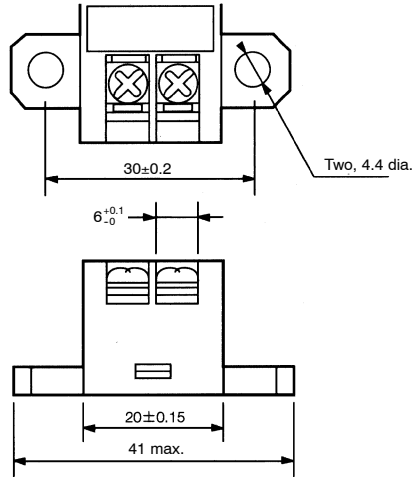
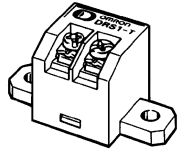

Mounting Holes

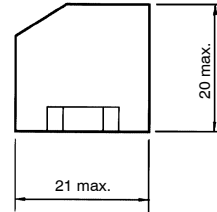
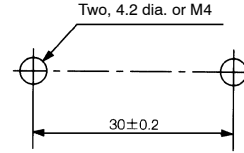

Precautions

Refer to the *DeviceNet Operation Manual (W267)* before using the Unit.

Correct Use

Refer to the *DeviceNet Operation Manual (W267)* for connecting or wiring T-branch Taps.

NOTE: DIMENSIONS SHOWN ARE IN MILLIMETERS. To convert millimeters to inches divide by 25.4.

OMRON[®]
OMRON ELECTRONICS, INC.
 One East Commerce Drive
 Schaumburg, IL 60173
1-800-55-OMRON

OMRON CANADA, INC.
 885 Milner Avenue
 Scarborough, Ontario M1B 5V8
416-286-6465