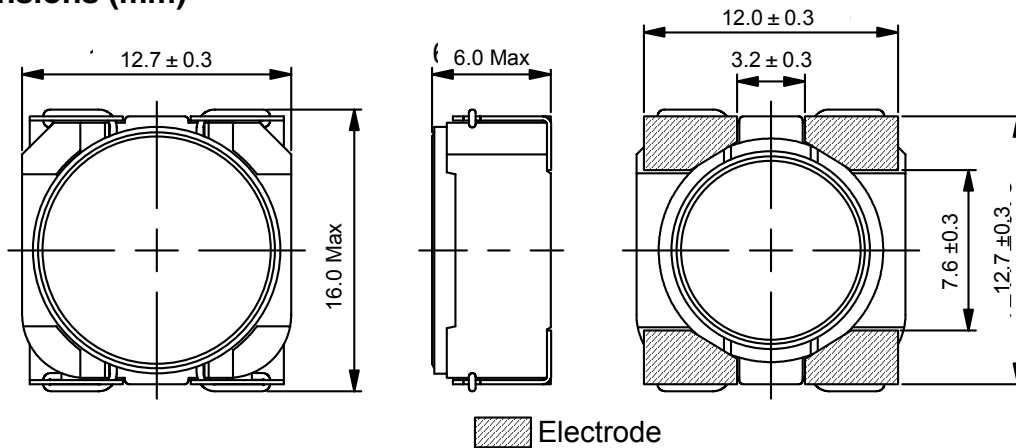
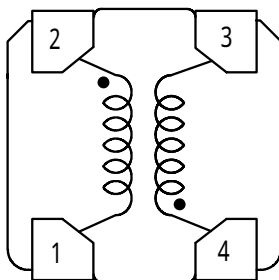

Type: CLS125
Product Description

- 4 Terminal pins' type gives a flexible design as inductors or transformers.
- Can also be used as a coupled inductor, two single inductors connected in parallel, as 1:1 transformer or as an autotransformer when connected in series.
- Core material: Ferrite.
- Custom design is available.

Feature

- Max. Operating frequency: 1MHz.
- 2 in 1 Coils for high efficiency up-down DC-DC converters.(SEPIC, Zeta, Cuk converter).
- Storage temperature range: -40 ~+105 .
- Operating temperature range: -40 ~+105 (including coil's self-heat).
- Product weight: 3.48g(Ref.).
- Ideally used in the power supply for DSC, Note PC, DVC and W-LED backlighting.
- RoHS Compliance.

Dimensions (mm)

Schematics (Bottom)

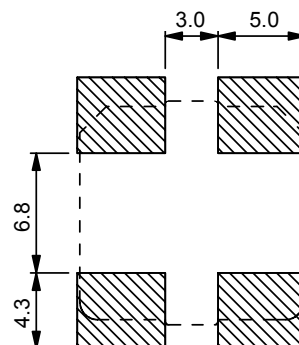
“ • ” indicates polarity.

Land Pattern (mm)

Type: CLS125
Specification

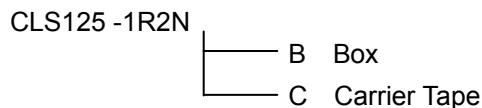
Part No.	Stamp	Inductance [Within]	D.C.R. [Max.] (m Ω)		Saturation Current (A) 2				Temperature Rise current (A) 3	
			(at 20 °C) 1		In parallel		In series		In parallel	In series
			(2-1)	(4-3)	at 20	at 100	at 20	at 100		
CLS125-1R2N	1R2	1.2μH±30%	9.7(8.1)	10.2(8.7)	13.0	12.0	6.8	6.0	10.30	4.65
CLS125-2R0N	2R0	2.0μH±30%	11.0(9.5)	12.8(10.7)	10.2	8.8	5.3	4.6	9.84	4.10
CLS125-3R0N	3R0	3.0μH±30%	13.7(11.5)	15.8(13.2)	8.5	7.4	4.5	3.8	8.80	4.08
CLS125-5R6N	5R6	5.6μH±30%	21.8(18)	25.0(20.9)	6.4	5.5	3.0	2.6	6.90	3.25
CLS125-7R0N	7R0	7.0μH±30%	24(20)	28(24)	5.7	4.8	2.9	2.5	6.60	2.88
CLS125-110N	110	11μH±30%	42(36)	50(42)	5.5	4.0	2.2	1.8	4.62	2.20
CLS125-150N	150	15μH±30%	54(45)	64(54)	4.8	3.9	1.8	1.5	4.30	1.92
CLS125-230N	230	23μH±30%	80(67)	96(80)	2.9	2.7	1.7	1.4	3.35	1.53
CLS125-380N	380	38μH±30%	115(176)	140(118)	2.6	2.2	1.3	1.1	2.80	1.30
CLS125-500N	500	50μH±30%	170(176)	210(145)	2.2	2.0	0.9	0.8	2.16	1.00
CLS125-750N	750	75μH±30%	365(220)	315(264)	1.8	1.5	0.8	0.7	1.78	0.80
CLS125-111N	111	110μH±30%	325(273)	400(335)	1.4	1.3	0.7	0.6	1.50	0.72

Description Of Part Name

1. () typical value.

2. Saturation Current: The DC current at which the inductance decreases to 90% of it's nominal value.

3. Temperature rise current: The DC current at which the temperature rise is $t = 40$ °C. ($T_a = 20$ °C).

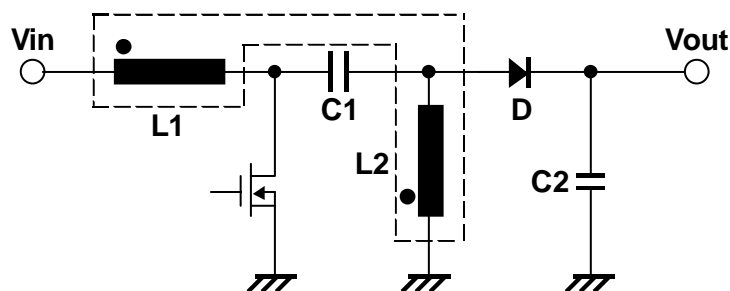
◆ Typical SEPIC Schematic

Type: CLS125

Typical L Vs Current (REF.)

Parallel mode L vs I_{dc} (at 20 °C) (REF.)

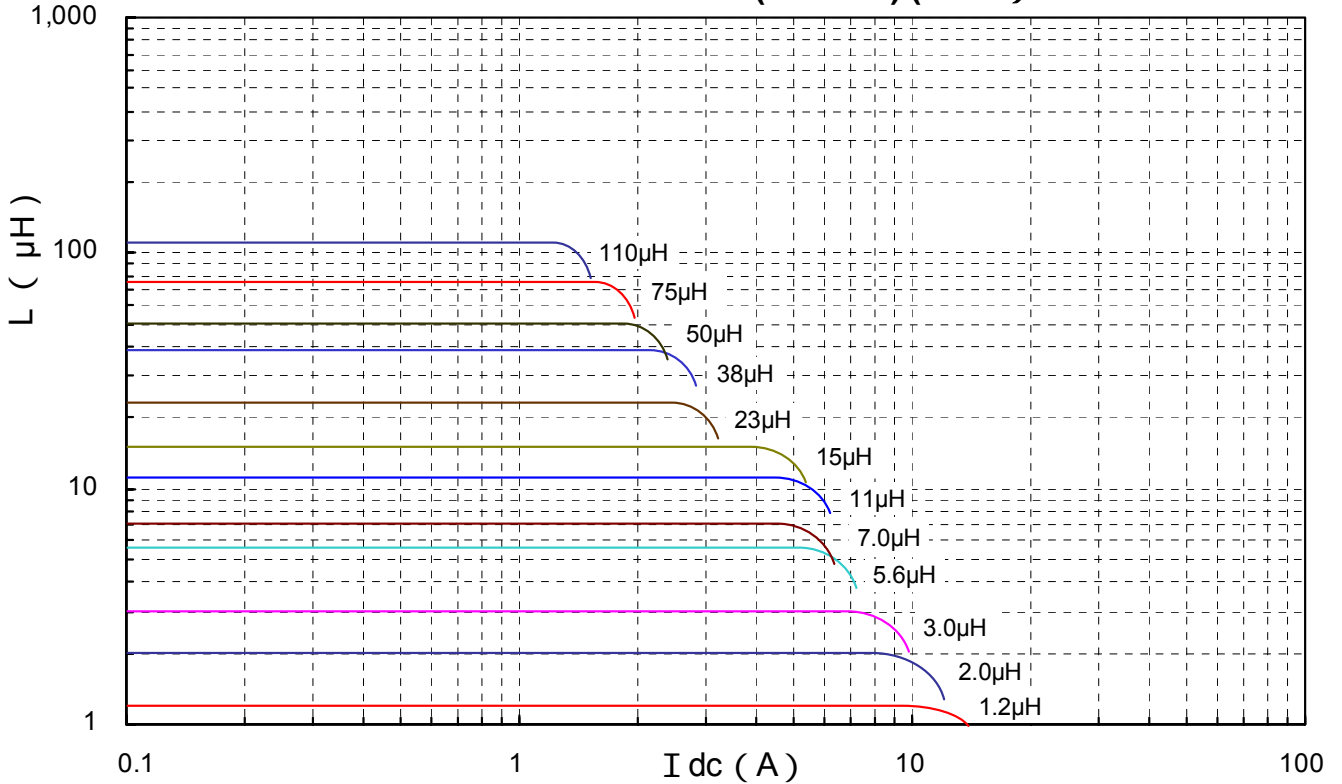

Series mode L vs I_{dc} (at 20 °C) (REF.)

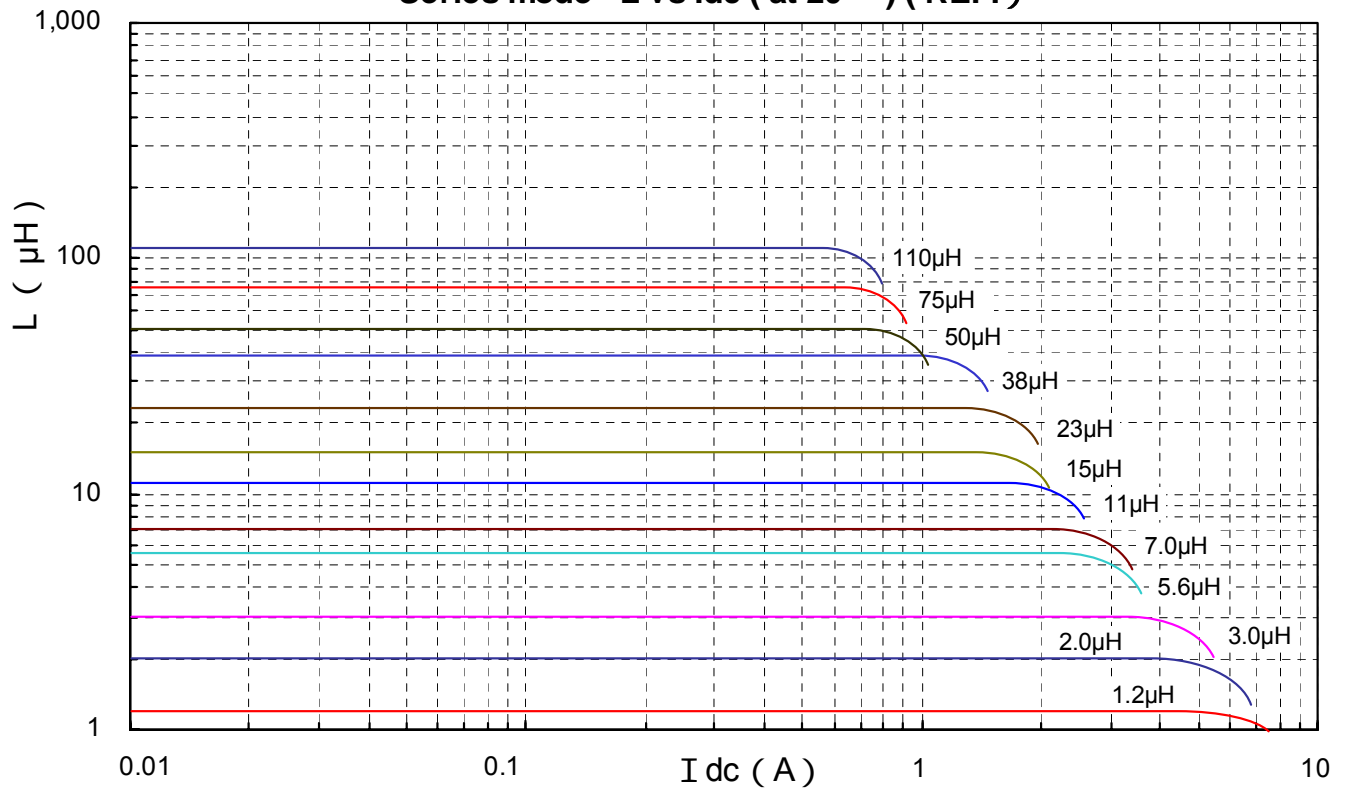

Type: CLS125

Recommendation Reflow Condition

Heat Endurance Test

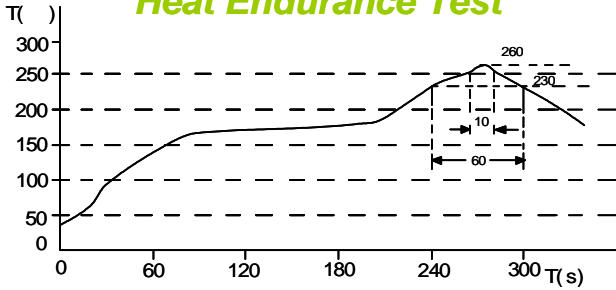

Temperature Chart

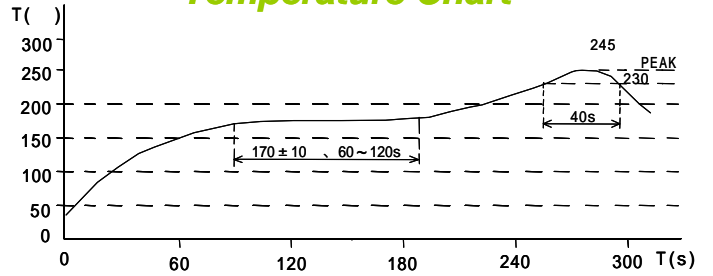

Packaging with Embossed Tape and Reel

Qty.: 500pcs/reel

