

PRODUCT NUMBER  
SEE TABLE

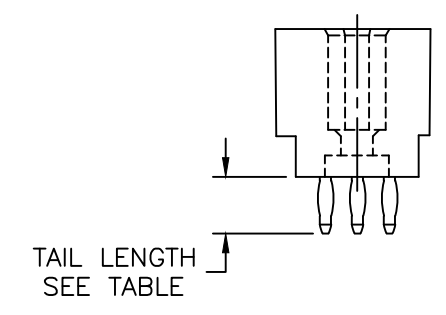
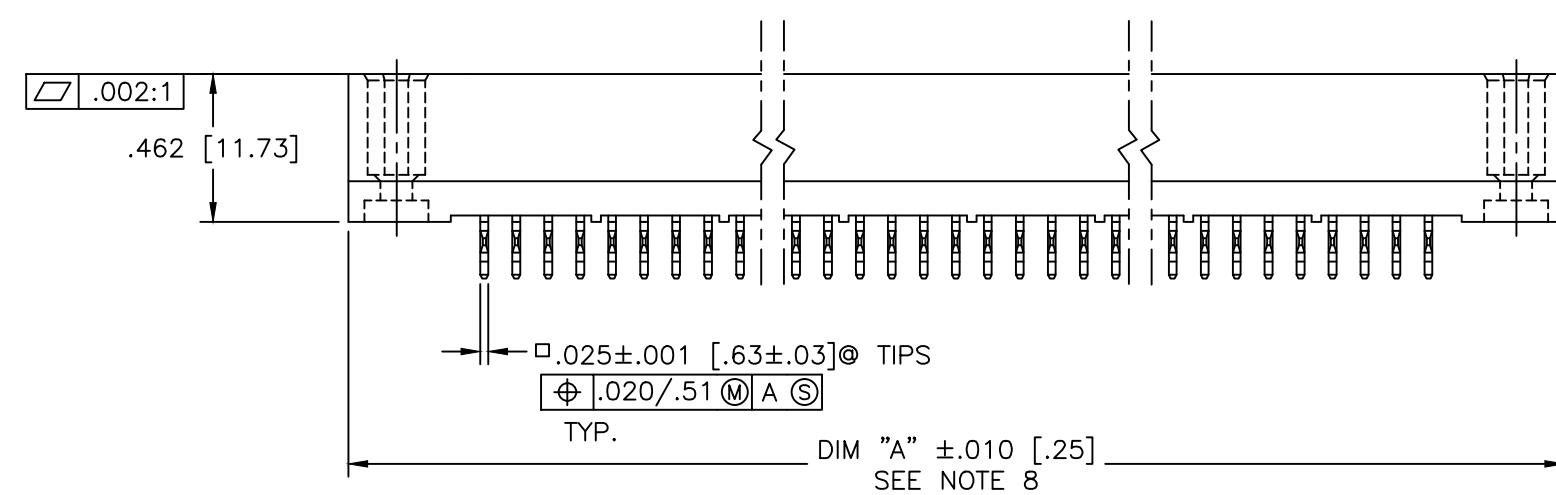
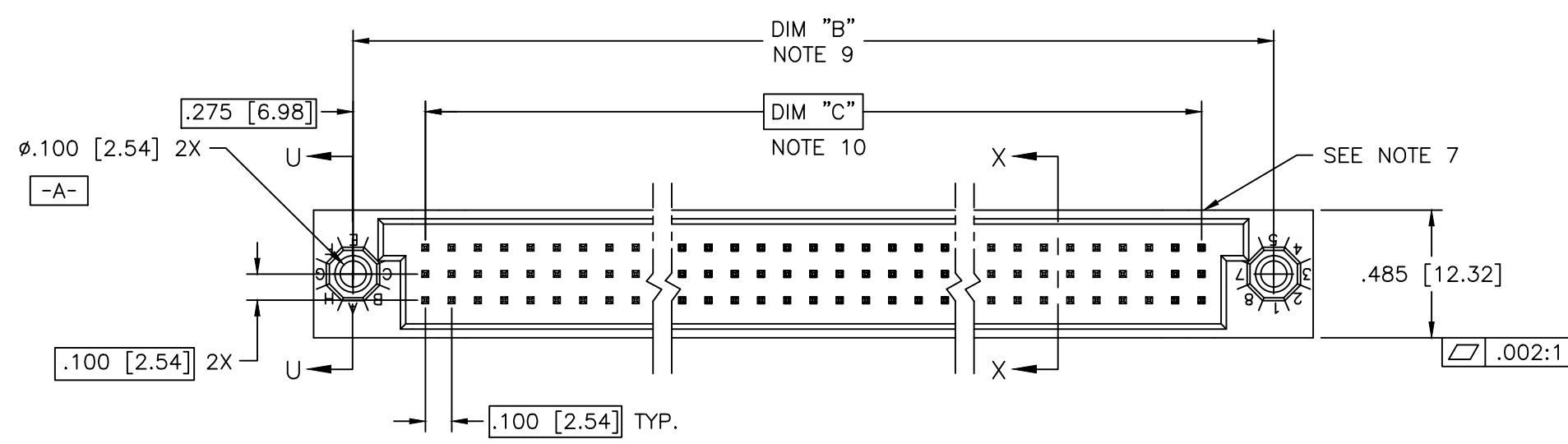

FCIconnect.com

Copyright FCI

mat'l. code SEE NOTE 3		surface ISO 1302 ✓	tolerance ISO 406 ISO 1101	projection INCH/MM	product family HPC														
ltr	ecn no	dr	date	tolerances unless otherwise specified	title 3 ROW VERTICAL HEADER W/PRESS-FIT PINS, 0 G.P.														
P	111-0094	SAL	2011-05-23	angles linear .XX±.01/.3 .XXX±.005/.13															
J	V05-0514	TAB	8/2/05	0°±2'	scale 1:1														
K	V05-0999	DAI	10/28/05	dr D.SHEAFER 1991-03-14	dwg no 50006 sheet 1 of 16 size A3														
L	V05-1039	DAI	11/11/05	enr S.CLARK 1991-03-14															
M	M06-0283	MHT	7/27/06	chr S.ALOSIOUS 2011-05-23	type Product Customer Drawing														
N	M06-0490	MHT	12/13/06	appd BIJU K PAUL 2011-05-23															
sheet	revision	P	P	P	P	P	P	P	P	P	P	P	P	P	P	P	P	P	P
index	sheet	1	2	3	4	5	6	7	8	9	10	11	12	13	14	15	16		

form: A3

PRODUCT NUMBER  
SEE TABLE

NOTES:

① PRODUCT NUMBERING CODE:  
50006 - X YYY Z LF  
LEAD FREE (OPTIONAL)  
TAIL LENGTH SEE TABLE  
NO. OF POSITIONS SEE NOTE 2  
PLATING SEE TABLE  
BASE NUMBER

PRODUCT NUMBERING CODE FOR  
SELECT LOAD PART NUMBERS:  
50006 - XX YYY LF  
LEAD FREE (OPTIONAL)  
SEQUENCE NUMBER  
ALWAYS 'XX'  
BASE NUMBER

- ② THIS PRODUCT IS CONFIGURED IN SIZES OF 6 THRU 80 COLUMNS IN INCREMENTS OF ONE. I.E.: 6,7,8,9,.....79,80.
- ③ HOUSING MATERIAL: GLASS AND MINERAL FILLED HIGH TEMP. THERMOPLASTIC. FLAME RETARDANT PER UL94V-0. COLOR: BLACK. PIN MATERIAL: PHOS BRONZE
- ④ CONTACT PLATING OPTIONS: SEE PRODUCT NUMBER TABLE
- ⑤  $\phi.0453/1.151$  DRILLED HOLE PLATED WITH  $.0003/.007$  MIN. SnPb OVER  $.001/.03$  TO  $.003/.08$  Cu. PLATING TO ACHIEVE A  $\phi.040 \pm .003/1.02 \pm .08$  HOLE.
- ⑥ TO ASSURE PROPER INSTALLATION: TOOLING, AS SPECIFIED IN INSTRUCTION MANUAL 155915-001 MUST BE USED. PIN MATING LENGTH WILL BE  $\pm .002/.05$  AFTER INSTALLATION.
- ⑦ COMPANY NAME, PART NUMBER AND LOT CODE TO APPEAR ON THIS SURFACE PER BUS-12-108.
- ⑧ DIM "A" CALCULATION =  $.100[2.54] \times \text{NO. OF COLUMNS} + .75[19.1]$
- ⑨ DIM "B" CALCULATION =  $.100[2.54] \times \text{NO. OF COLUMNS} + .450[11.43]$
- ⑩ DIM "C" CALCULATION =  $.100[2.54] \times \text{NO. OF COLUMNS} - .100[2.54]$
- 11. ALL POSITIONS ARE LOADED EXCEPT FOR -XXYYY ASSEMBLIES WHICH HAVE SELECTIVE LOADING.
- ⑫ REFERENCE 50807 FOR F.M.L.B. AVAILABLE OPTIONS AND WORKSHEET.
- 13. THIS PRODUCT (WITH 'LF' SUFFIX) MEETS EUROPEAN UNION DIRECTIVES AND OTHER COUNTRY REGULATIONS AS DESCRIBED IN GS-22-008.
- 14. THIS HOUSING WILL WITHSTAND EXPOSURE TO 260°C PEAK TEMPERATURE FOR 10-30 SECONDS IN A CONVECTION, INFRA-RED OR VAPOR PHASE REFLOW OVEN.

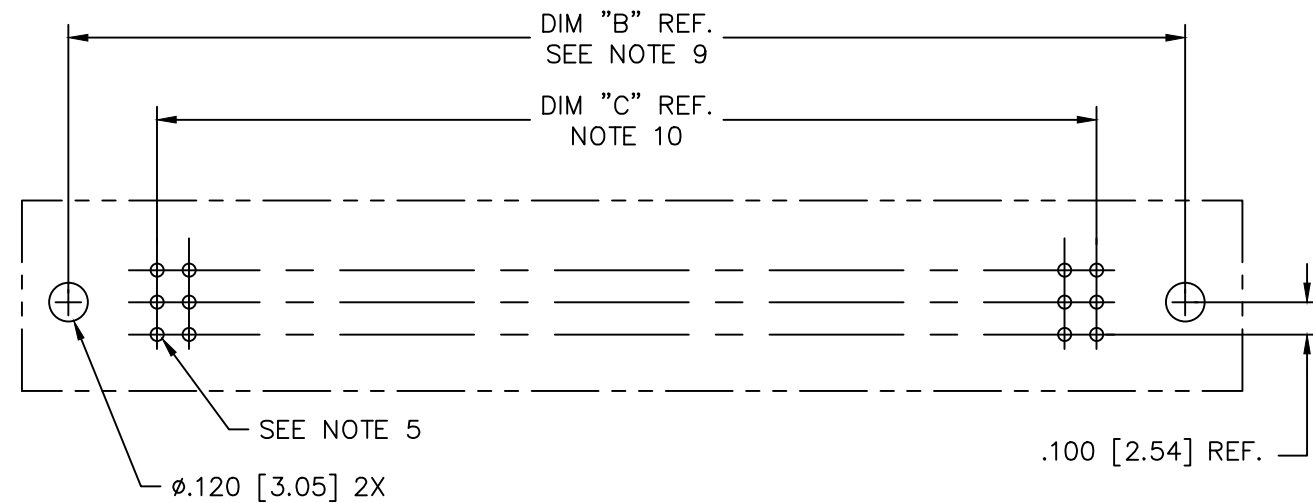
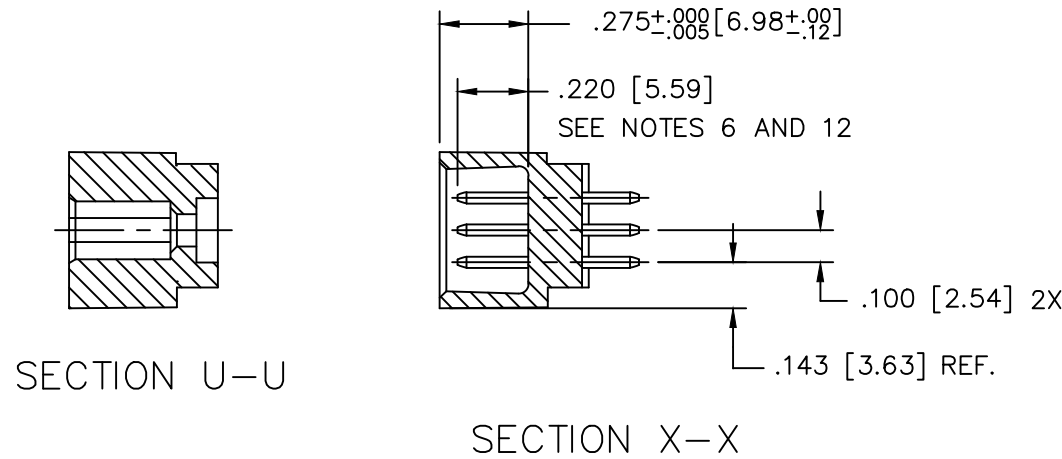

RECOMMENDED PCB LAYOUT  
(ALL HOLES LOCATED ON  $.100/2.54$  GRID UNLESS OTHERWISE SPECIFIED)

mat'l. code SEE NOTE 3		surface ISO 1302	tolerance ISO 406 ISO 1101	projection 	product family HPC
ltr	ecn no	dr	date	tolerances unless otherwise specified	title
P				angles linear .XX±.01/.3 .XXX±.005/.13 .XXXX±.0020/.05	3 ROW VERTICAL HEADER W/PRESS-FIT PINS, 0 G.P.
				0°±2'	scale 1:1
		dr	D.SHEAFER	1991-03-14	dwg no
		enr	S.CLARK	1991-03-14	sheet 2 of 16
		chr	S ALOSIOUS	2011-05-23	50006
		appd	BIJU K PAUL	2011-05-23	A3
sheet index	revision sheet				type Product Customer Drawing

PRODUCT NO.	NUMBER OF POSITIONS NOTE 2	TAIL LENGTH ±.015/0.38	CONTACT PLATING
50006-1YYYA	YYY	.177/4.50	30u"/.76u GOLD
50006-1YYC	YYY	.533/13.54	30u"/.76u GOLD
50006-1YYD	YYY	.733/18.62	30u"/.76u GOLD
50006-1YYG	YYY	.250/6.35	30u"/.76u GOLD
50006-1YYL	YYY	.188/4.78	30u"/.76u GOLD
50006-1YYP	YYY	.470/11.94	30u"/.76u GOLD
50006-3YYA	YYY	.177/4.50	50u"/1.27u GOLD
50006-3YYC	YYY	.533/13.54	50u"/1.27u GOLD
50006-3YYD	YYY	.733/18.62	50u"/1.27u GOLD
50006-3YYG	YYY	.250/6.35	50u"/1.27u GOLD
50006-3YYL	YYY	.188/4.78	50u"/1.27u GOLD
50006-3YYP	YYY	.470/11.94	50u"/1.27u GOLD
50006-5YYA	YYY	.177/4.50	30u"/.76u GXT
50006-5YYALF	YYY	.177/4.50	30u"/.76u GXT
50006-5YYC	YYY	.533/13.54	30u"/.76u GXT
50006-5YYCLF	YYY	.533/13.54	30u"/.76u GXT
50006-5YYD	YYY	.733/18.62	30u"/.76u GXT
50006-5YYDLF	YYY	.733/18.62	30u"/.76u GXT
50006-5YYG	YYY	.250/6.35	30u"/.76u GXT
50006-5YYGLF	YYY	.250/6.35	30u"/.76u GXT
50006-5YYL	YYY	.188/4.78	30u"/.76u GXT
50006-5YYLLF	YYY	.188/4.78	30u"/.76u GXT
50006-5YYP	YYY	.470/11.94	30u"/.76u GXT
50006-5YYPLF	YYY	.470/11.94	30u"/.76u GXT
50006-XX010	150	SEE SHEET 4	30u"/.76u GXT
50006-XX010LF	150	SEE SHEET 4	30u"/.76u GXT
50006-XX025	18	SEE SHEET 5	30u"/.76u GXT
50006-XX025LF	18	SEE SHEET 5	30u"/.76u GXT
50006-XX027	96	SEE SHEET 6	30u"/.76u GOLD
50006-XX027LF	96	SEE SHEET 6	30u"/.76u GXT
50006-XX028	30	SEE SHEET 7	30u"/.76u GOLD
50006-XX028LF	30	SEE SHEET 7	30u"/.76u GXT
50006-XX045	180	SEE SHEET 8	30u"/.76u GXT
50006-XX045LF	180	SEE SHEET 8	30u"/.76u GXT
50006-XX049	96	SEE SHEET 9	30u"/.76u GOLD
50006-XX049LF	96	SEE SHEET 9	30u"/.76u GXT
50006-XX053	150	SEE SHEET 10	30u"/.76u GXT
50006-XX053LF	150	SEE SHEET 10	30u"/.76u GXT
50006-XX054	150	SEE SHEET 11	30u"/.76u GOLD
50006-XX054LF	150	SEE SHEET 11	30u"/.76u GXT
50006-XX055	30	SEE SHEET 12	30u"/.76u GOLD
50006-XX055LF	30	SEE SHEET 12	30u"/.76u GXT
50006-XX056	150	SEE SHEET 13	30u"/.76u GOLD
50006-XX056LF	150	SEE SHEET 13	30u"/.76u GXT
50006-XX057	150	SEE SHEET 14	30u"/.76u GOLD
50006-XX057LF	150	SEE SHEET 14	30u"/.76u GXT
50006-XX058	240	SEE SHEET 15	50u"/1.27u GOLD
50006-XX058LF	240	SEE SHEET 15	50u"/1.27u GXT
50006-XX059	240	SEE SHEET 16	50u"/1.27u GOLD
50006-XX059LF	240	SEE SHEET 16	50u"/1.27u GXT

mat'l. code SEE NOTE 3		surface ISO 1302	tolerance ISO 406 ISO 1101	projection 	product family HPC
ltr	ecn no	dr	date	tolerances unless otherwise specified	title
P				angles linear .XX±.01/.3 .XXX±.005/.13 .XXXX±.0020/.051	3 ROW VERTICAL HEADER W/PRESS-FIT PINS, 0 G.P.
				0°±2'	INCH/MM scale 1:1
		dr	D.SHEAFER	1991-03-14	dwg no
		enr	S.CLARK	1991-03-14	sheet 3 of 16 size
		chr	S ALOSIOUS	2011-05-23	50006 A3
		appd	BIJU K PAUL	2011-05-23	type Product Customer Drawing
sheet index	revision sheet				

FCJ  
 FClconnect.com  
 Copyright FCJ

PRODUCT NUMBER
50006-XX010
50006-XX010LF

FOR PRODUCT NUMBERS 50006-XX010 AND 50006-XX010LF ONLY

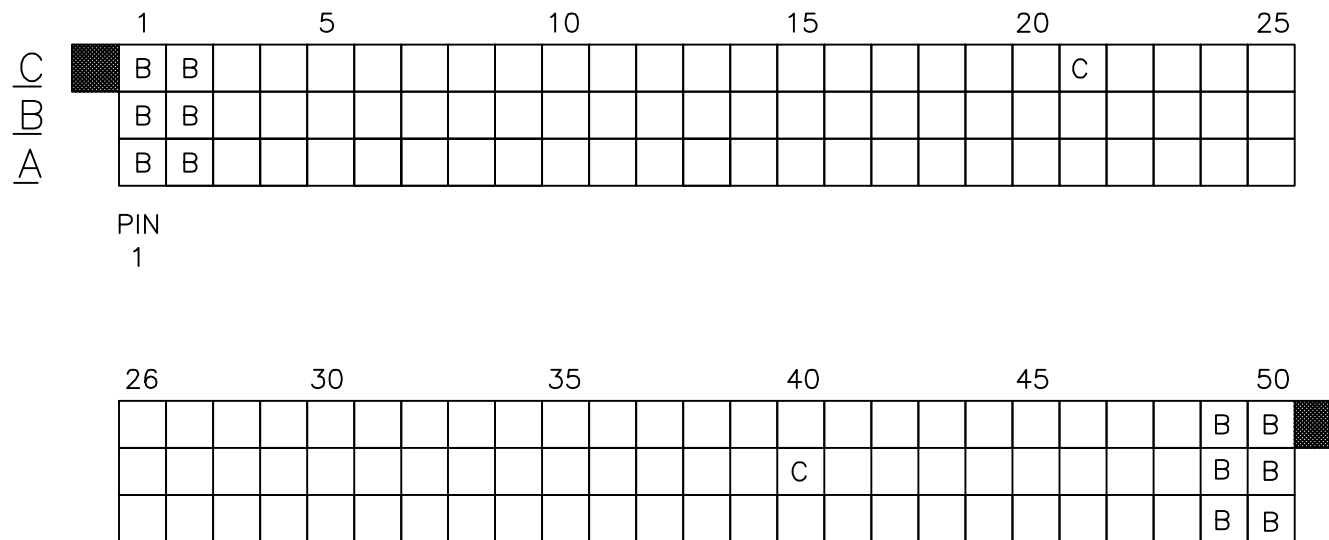

NOTES FOR 50006-XX010 AND 50006-XX010LF ONLY:

- ALL POSITIONS ARE LOADED WITH "A" EXCEPT AS SHOWN.
- COLUMN 1, ROW A IS DESIGNATED AS SIGNAL PIN 1, AS VIEWED FROM THE MATING FACE.
- SIGNAL DATA FOR 50006-XX010 AND 50006-XX010LF:  
 SIZE 3 x 50  
 TOTAL NO. OF POSITIONS - 150  
 NO. OF POSITIONS LOADED - 150

ITEM KEY	QTY.	MATING LENGTH	TAIL LENGTH
A	136	.200 / 5.08	.177 / 4.50
B	12	.200 / 5.08	.533 / 13.54
C	2	.240 / 6.10	.177 / 4.50

mat'l. code		surface ISO 1302	tolerance ISO 406 ISO 1101	projection 	product family HPC
ltr	ecn no	dr	date	tolerances unless otherwise specified	title
P				angles 0°±2'	3 ROW VERTICAL HEADER W/PRESS-FIT PINS, 0 G.P.
				linear .XX±.01/.3 .XXX±.005/.13 .XXXX±.0020/.051	INCH/MM scale 1:1
		dr	D.SHEAFER	1991-03-14	dwg no
		enr	S.CLARK	1991-03-14	sheet 4 of 16 size
		chr	S ALOSIUS	2011-05-23	50006 A3
		appd	BIJU K PAUL	2011-05-23	type Product Customer Drawing
sheet index	revision sheet				

form: A3

PRODUCT NUMBER
50006-XX025
50006-XX025LF

FOR PRODUCT NUMBERS 50006-XX025 AND 50006-XX025LF ONLY

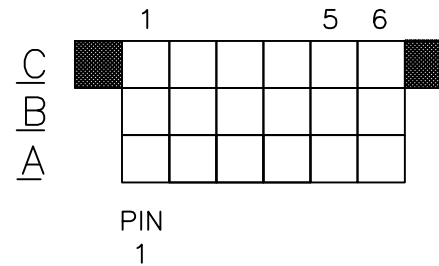

CUSTOMER NOTE: END GUIDE PINS ARE SUGGESTED IN YOUR APPLICATION TO PREVENT STUBBING OF THE .260/6.60 MATING LENGTH SIGNAL PINS.

NOTES FOR 50006-XX025 AND 50006-XX025LF ONLY:

- ALL POSITIONS ARE LOADED WITH "A" .
- COLUMN 1, ROW A IS DESIGNATED AS SIGNAL PIN 1, AS VIEWED FROM THE MATING FACE.
- SIGNAL DATA FOR 50006-XX025 AND 50006-XX025LF:  
SIZE 3 x 6  
TOTAL NO. OF POSITIONS - 18  
NO. OF POSITIONS LOADED - 18

ITEM KEY	QTY.	MATING LENGTH	TAIL LENGTH
A	18	.260 / 6.60	.533 / 13.54

mat'l. code		surface ISO 1302 ✓		tolerance ISO 406 ISO 1101		projection 		product family HPC	
ltr	ecn no	dr	date	tolerances unless otherwise specified		INCH/MM		title	
P				angles	linear	.XX±.01/.3		3 ROW VERTICAL HEADER	
				0°±2°		.XXX±.005/.13		W/PRESS-FIT PINS, 0 G.P.	
						.XXXX±.0020/.051		scale 1:1	
		dr	D.SHEAFER	1991-03-14			FCJ		dwg no
		enr	S.CLARK	1991-03-14					sheet 5 of 16
		chr	S ALOSIOUS	2011-05-23					50006
		appd	BIJU K PAUL	2011-05-23					A3
sheet index	revision sheet								type Product Customer Drawing

form: A3

PRODUCT NUMBER
50006-XX027
50006-XX027LF

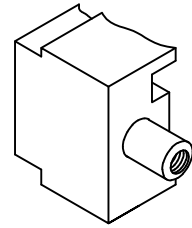

L.E.

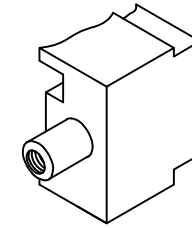

R.E.

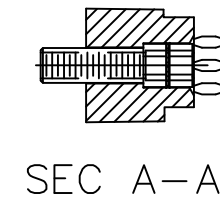
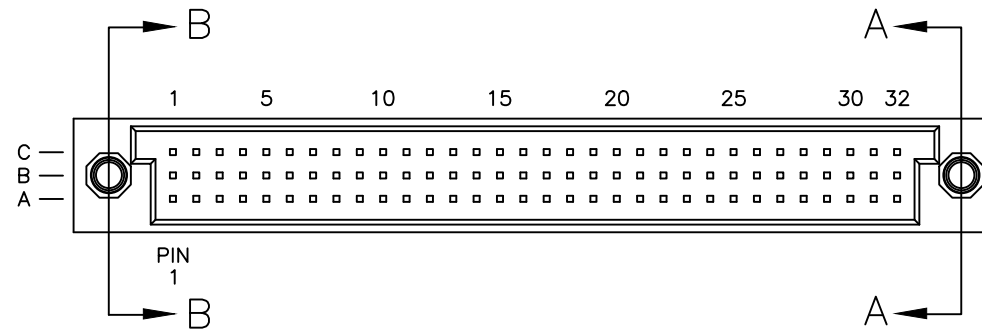
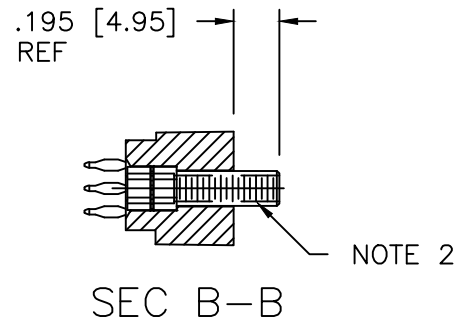

FOR PRODUCT NUMBERS 50006-XX027 AND 50006-XX027LF

NOTES:

1. IDENTICAL TO P/N 50006-1096A EXCEPT AS SHOWN W/JACK SCREW INSERTS INSTALLED ON BOTH ENDS.
2. HARDWARE P/N 95729-001.

mat'l. code		surface ISO 1302		tolerance ISO 406 ISO 1101		projection 		product family HPC	
ltr	ecn no	dr	date	tolerances unless otherwise specified		INCH/MM		title 3 ROW VERTICAL HEADER W/PRESS-FIT PINS, 0 G.P.	
P				angles	linear	.XX±.01/.3 .XXX±.005/.13 .XXXX±.0020/.051		dwg no 50006	
				0°±2°		scale 1:1		sheet 6 of 16 size A3	
		dr	D.SHEAFER	1991-03-14				type Product Customer Drawing	
		enr	S.CLARK	1991-03-14					
		chr	S ALOSIOUS	2011-05-23					
		appd	BIJU K PAUL	2011-05-23					
sheet index	revision sheet								

form: A3

PRODUCT NUMBER
50006-XX028
50006-XX028LF

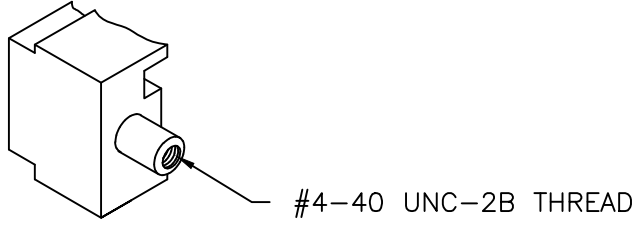

L.E.

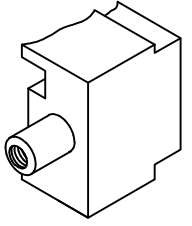

R.E.

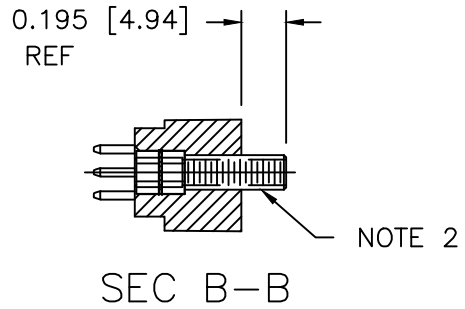

SEC B-B

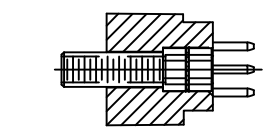
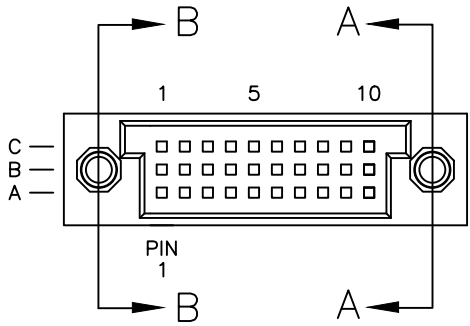

SEC A-A

FOR PRODUCT NUMBERS 50006-XX028 AND 50006-XX028LF

NOTES:

1. IDENTICAL TO P/N 50006-1030A EXCEPT AS SHOWN W/JACK SCREW INSERTS INSTALLED ON BOTH ENDS.
2. HARDWARE P/N 95729-001.



Copyright FCI

mat'l. code		surface ISO 1302		tolerance ISO 406 ISO 1101		projection 		product family HPC	
ltr	ecn no	dr	date	tolerances unless otherwise specified		INCH/MM		title 3 ROW VERTICAL HEADER W/PRESS-FIT PINS, 0 G.P.	
P				angles	linear	.XX±.01/.3 .XXX±.005/.13 .XXXX±.0020/.051		dwg no 50006	
				0°±2°		scale 1:1		sheet 7 of 16 size A3	
		dr	D.SHEAFER	1991-03-14				type Product Customer Drawing	
		enr	S.CLARK	1991-03-14					
		chr	S ALOSIOUS	2011-05-23					
		appd	BIJU K PAUL	2011-05-23					
sheet index	revision sheet								

form: A3

PRODUCT NUMBER
50006-XX045
50006-XX045LF

FOR PRODUCT NUMBERS 50006-XX045 AND 50006-XX045LF ONLY

	1	5	10	15	20	25	30
C	■						
B							
A							

PIN

1

	31	35	40	45	50	55	60	■

NOTES FOR 50006-XX045 AND 50006-XX045LF ONLY:

- ALL POSITIONS ARE LOADED WITH "A".
- COLUMN 1, ROW A IS DESIGNATED AS SIGNAL PIN 1, AS VIEWED FROM THE MATING FACE.
- SIGNAL DATA FOR 50006-XX045 AND 50006-XX045LF:  
SIZE 3 x 60  
TOTAL NO. OF POSITIONS - 180  
NO. OF POSITIONS LOADED - 180

ITEM KEY	QTY.	MATING LENGTH	TAIL LENGTH
A	180	.220 - 5.59	.597 - 15.16

mat'l. code		surface ISO 1302	tolerance ISO 406 ISO 1101	projection 	product family HPC
ltr	ecn no	dr	date	tolerances unless otherwise specified	title
P				angles linear 0°±2'	3 ROW VERTICAL HEADER W/PRESS-FIT PINS, 0 G.P.
				.XX±.01/.3 .XXX±.005/.13 .XXXX±.0020/.051	INCH/MM scale 1:1
		dr	D.SHEAFER	1991-03-14	dwg no
		enr	S.CLARK	1991-03-14	sheet 8 of 16
		chr	S ALOSIOUS	2011-05-23	50006
		appd	BIJU K PAUL	2011-05-23	A3
sheet index	revision sheet				type Product Customer Drawing



Copyright FCI



PRODUCT NUMBER
50006-XX049
50006-XX049LF

FOR PRODUCT NUMBER 50006-XX049 AND 50006-XX049LF ONLY

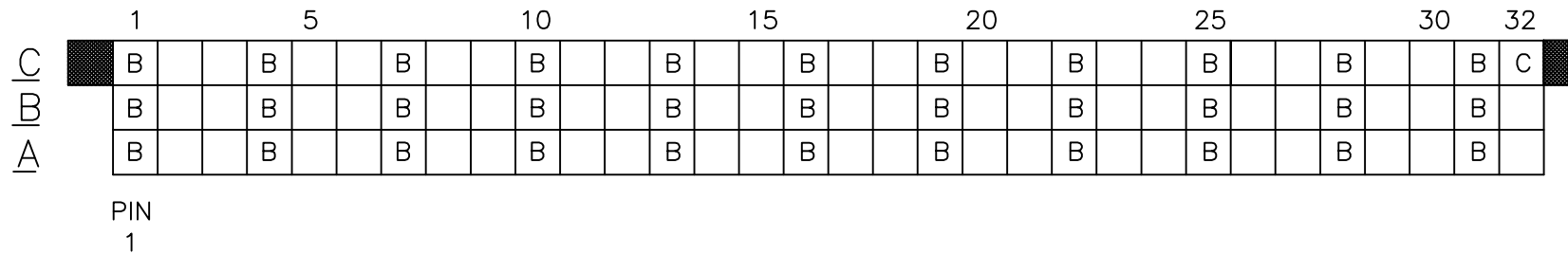

CUSTOMER NOTE: END GUIDE PINS ARE SUGGESTED IN YOUR APPLICATION TO PREVENT STUBBING OF THE .260/6.60 MATING LENGTH SIGNAL PINS.

NOTES FOR 50006-XX049 AND 50006-XX049LF ONLY:

- ALL POSITIONS ARE LOADED WITH "A" EXCEPT AS SHOWN.
- COLUMN 1, ROW A IS DESIGNATED AS SIGNAL PIN 1, AS VIEWED FROM THE MATING FACE.
- SIGNAL DATA FOR 50006-XX049 AND 50006-XX049LF:  
 SIZE 3 x 32  
 TOTAL NO. OF POSITIONS - 96  
 NO. OF POSITIONS LOADED - 96

ITEM KEY	QTY.	MATING LENGTH	TAIL LENGTH
A	62	.220 / 5.59	.177 / 4.50
B	33	.260 / 6.60	.177 / 4.50
C	1	.180 / 4.57	.177 / 4.50

mat'l. code		surface ISO 1302	tolerance ISO 406 ISO 1101	projection	product family HPC
ltr	ecn no	dr	date	tolerances unless otherwise specified	title
P				angles linear 0°±2'	3 ROW VERTICAL HEADER W/PRESS-FIT PINS, 0 G.P.
				.XX±.01/.3 .XXX±.005/.13 .XXXX±.0020/.051	INCH/MM scale 1:1
		dr	D.SHEAFER	1991-03-14	dwg no
		enr	S.CLARK	1991-03-14	sheet 9 of 16 size
		chr	S ALOSIUS	2011-05-23	50006 A3
		appd	BIJU K PAUL	2011-05-23	type Product Customer Drawing
sheet index	revision sheet				

FCJ  
FCconnect.com  
Copyright FCJ

PRODUCT NUMBER
50006-XX053
50006-XX053LF

FOR PRODUCT NUMBERS 50006-XX053 AND 50006-XX053LF ONLY

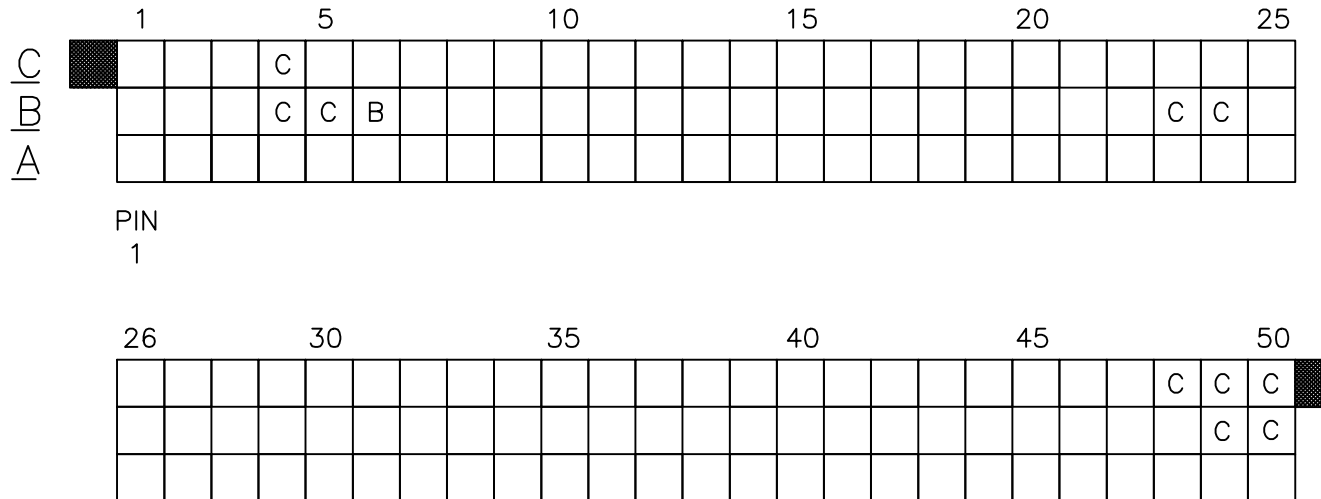

CUSTOMER NOTE: END GUIDE PINS ARE SUGGESTED IN YOUR APPLICATION TO PREVENT STUBBING OF THE .260 MATING LENGTH SIGNAL PINS.

- ALL POSITIONS ARE LOADED WITH "A" EXCEPT AS SHOWN.
- COLUMN 1, ROW A IS DESIGNATED AS SIGNAL PIN 1, AS VIEWED FROM THE MATING FACE.
- SIGNAL DATA FOR 50006-XX053 AND 50006-XX053LF:  
 SIZE 3 x 50  
 TOTAL NO. OF POSITIONS - 150  
 NO. OF POSITIONS LOADED - 150

ITEM KEY	QTY.	MATING LENGTH	TAIL LENGTH
A	139	.220 / 5.59	.250 / 6.35
B	1	.180 / 4.57	.250 / 6.35
C	10	.260 / 6.60	.250 / 6.35

mat'l. code		surface ISO 1302	tolerance ISO 406 ISO 1101	projection 	product family HPC
ltr	ecn no	dr	date	tolerances unless otherwise specified	title
P				angles linear 0°±2'	3 ROW VERTICAL HEADER W/PRESS-FIT PINS, 0 G.P.
				.XX±.01/.3 .XXX±.005/.13 .XXXX±.0020/.051	INCH/MM
				dr D.SHEAFER 1991-03-14	scale 1:1
				enr S.CLARK 1991-03-14	FCJ
				chr S.ALOSIOUS 2011-05-23	dwg no 50006 sheet 10 of 16 size A3
				appd BIJU K PAUL 2011-05-23	type Product Customer Drawing
sheet index	revision sheet				

form: A3

PRODUCT NUMBER
50006-XX054
50006-XX054LF

FOR PRODUCT NUMBERS 50006-XX054 AND 50006-XX054LF ONLY

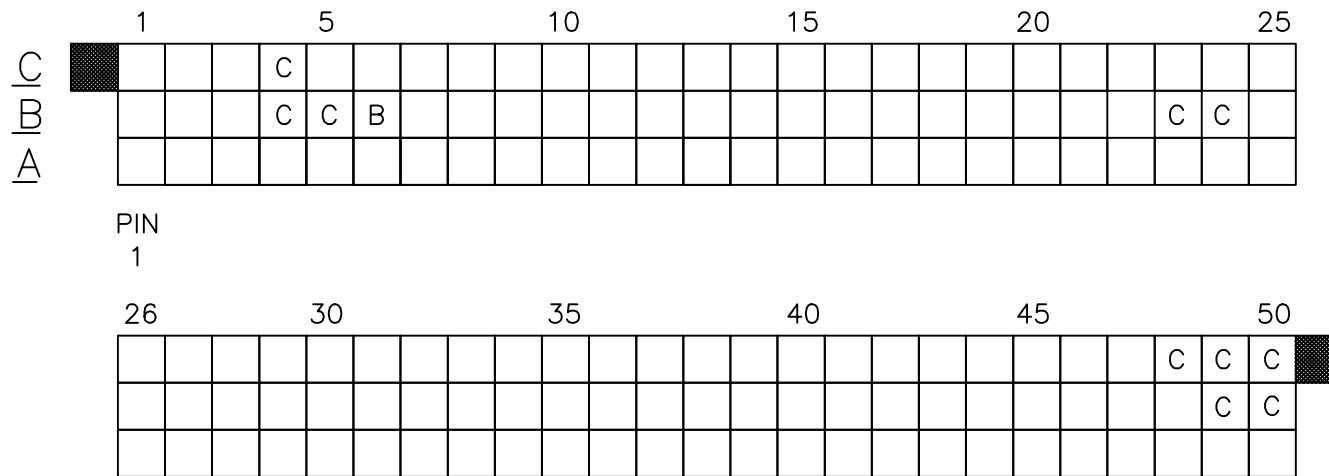

CUSTOMER NOTE: END GUIDE PINS ARE SUGGESTED IN YOUR APPLICATION TO PREVENT STUBBING OF THE .260 MATING LENGTH SIGNAL PINS.

NOTES FOR 50006-XX054 AND 50006-XX054LF ONLY:

- ALL POSITIONS ARE LOADED WITH "A" EXCEPT AS SHOWN.
- COLUMN 1, ROW A IS DESIGNATED AS SIGNAL PIN 1, AS VIEWED FROM THE MATING FACE.
- SIGNAL DATA FOR 50006-XX054 AND 50006-XX054LF:  
 SIZE 3 x 50  
 TOTAL NO. OF POSITIONS - 150  
 NO. OF POSITIONS LOADED - 150

ITEM KEY	QTY.	MATING LENGTH	TAIL LENGTH
A	139	.220 / 5.59	.561 / 14.25
B	1	.180 / 4.57	.521 / 13.23
C	10	.260 / 6.60	.601 / 15.27

mat'l. code		surface ISO 1302	tolerance ISO 406 ISO 1101	projection	product family HPC
ltr	ecn no	dr	date	tolerances unless otherwise specified	title
P				angles linear .XX±.01/.3 .XXX±.005/.13 .XXXX±.0020/.051	3 ROW VERTICAL HEADER W/PRESS-FIT PINS, 0 G.P.
				0°±2'	INCH/MM
				dr D.SHEAFER 1991-03-14	scale 1:1
				enr S.CLARK 1991-03-14	FCJ
				chr S ALOSIUS 2011-05-23	dwg no 50006 sheet 11 of 16 size A3
				appd BIJU K PAUL 2011-05-23	type Product Customer Drawing
sheet index	revision sheet				

form: A3

PRODUCT NUMBER
50006-XX055
50006-XX055LF

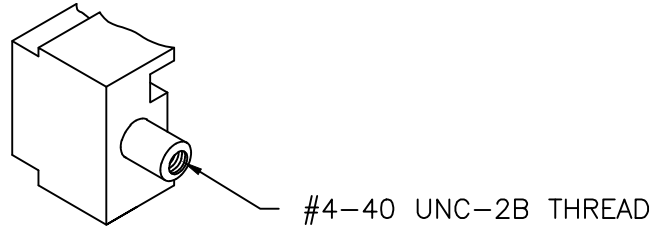

L.E.

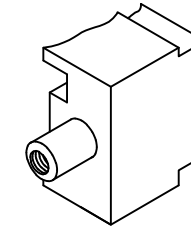

R.E.

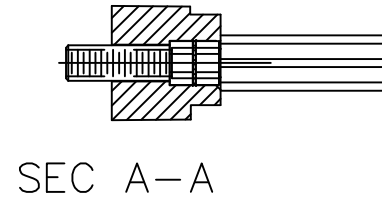
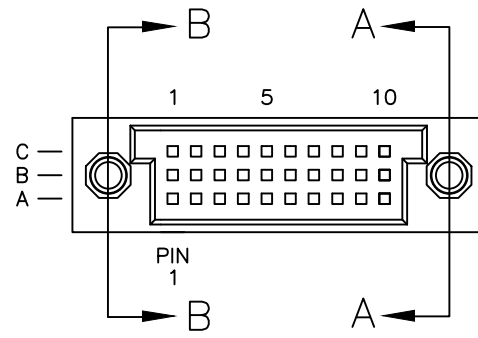
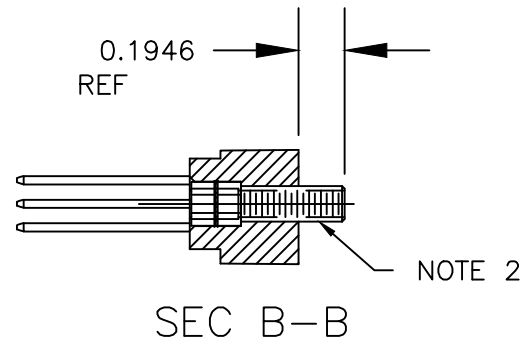

FOR PRODUCT NUMBERS 50006-XX055 AND 50006-XX055LF

NOTES:

- IDENTICAL TO P/N 50006-1030D EXCEPT AS SHOWN W/JACK SCREW INSERTS INSTALLED ON BOTH ENDS.
- HARDWARE P/N 95729-001.

mat'l. code		surface ISO 1302		tolerance ISO 406 ISO 1101		projection 		product family HPC	
ltr	ecn no	dr	date	tolerances unless otherwise specified		INCH/MM		title 3 ROW VERTICAL HEADER W/PRESS-FIT PINS, 0 G.P.	
P				angles	linear	.XX±.01/.3		dwg no	
				0°±2'		.XXX±.005/.13		sheet 12 of 16 size	
						.XXX±.0020/.051		50006 A3	
		dr	D.SHEAFER	1991-03-14		scale 1:1		type Product Customer Drawing	
		enr	S.CLARK	1991-03-14					
		chr	S ALOSIOUS	2011-05-23					
		appd	BIJU K PAUL	2011-05-23					
sheet index	revision sheet								

Copyright FCJ  
FCJ  
FCconnect.com

PRODUCT NUMBER
50006-XX056
50006-XX056LF

FOR PRODUCT NUMBER 50006-XX056 AND 50006-XX056LF ONLY

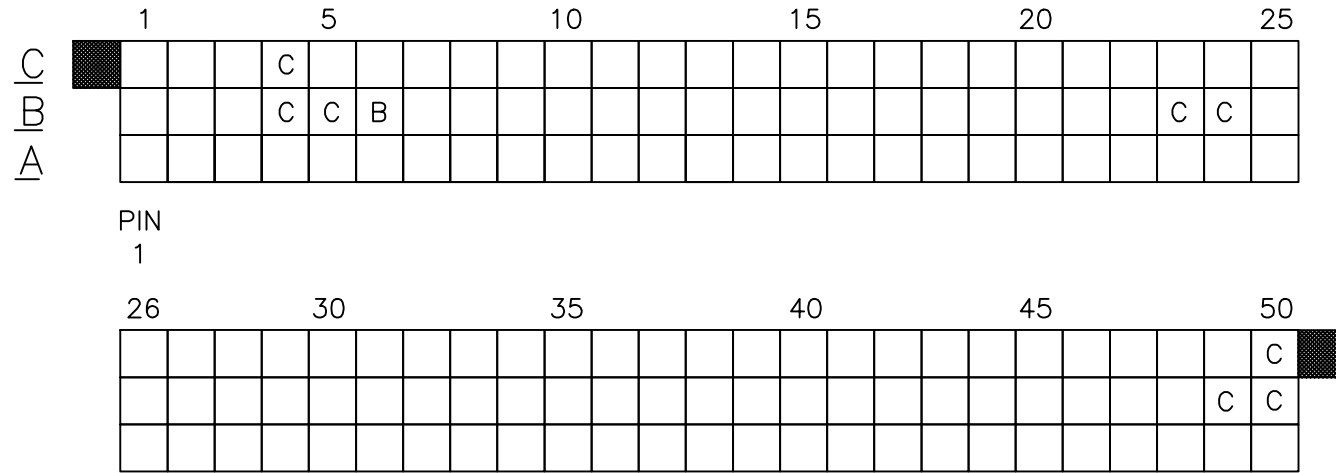

CUSTOMER NOTE: END GUIDE PINS ARE SUGGESTED IN YOUR APPLICATION TO PREVENT STUBBING OF THE .260 MATING LENGTH SIGNAL PINS.

NOTES FOR 50006-XX056 AND 50006-XX056LF ONLY:

1. ALL POSITIONS ARE LOADED WITH "A" EXCEPT AS SHOWN.
2. COLUMN 1, ROW A IS DESIGNATED AS SIGNAL PIN 1, AS VIEWED FROM THE MATING FACE.
3. SIGNAL DATA FOR 50006-XX056 AND 50006-XX056LF:  
 SIZE 3 x 50  
 TOTAL NO. OF POSITIONS - 150  
 NO. OF POSITIONS LOADED - 150

ITEM KEY	QTY.	MATING LENGTH	TAIL LENGTH
A	141	.220 / 5.59	.177 / 4.50
B	1	.180 / 4.57	.177 / 4.50
C	8	.260 / 6.60	.177 / 4.50

mat'l. code		surface ISO 1302		tolerance ISO 406 ISO 1101		projection 		product family HPC	
ltr	ecn no	dr	date	tolerances unless otherwise specified		INCH/MM		title 3 ROW VERTICAL HEADER W/PRESS-FIT PINS, 0 G.P.	
P				angles	linear	.XX±.01/.3		dwg no 50006	
				0°±2'		.XXX±.005/.13		sheet 13 of 16 size A3	
						.XXXX±.0020/.051		type Product Customer Drawing	
		dr	D.SHEAFER	1991-03-14					
		enr	S.CLARK	1991-03-14					
		chr	S ALOSIOUS	2011-05-23					
		appd	BIJU K PAUL	2011-05-23					
sheet index	revision sheet								

FCJ  
 FCconnect.com  
 Copyright FCJ

PRODUCT NUMBER
50006-XX057
50006-XX057LF

FOR PRODUCT NUMBER 50006-XX057 AND 50006-XX057LF

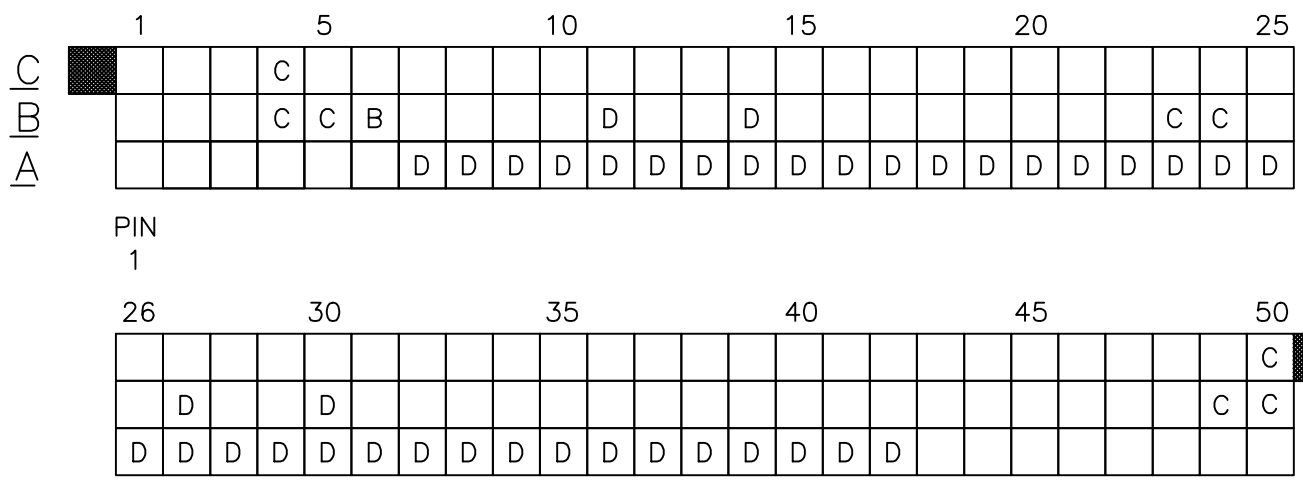

CUSTOMER NOTE: END GUIDE PINS ARE SUGGESTED IN YOUR APPLICATION TO PREVENT STUBBING OF THE .260 MATING LENGTH SIGNAL PINS.

- NOTES FOR 50006-XX057 AND 50006-XX057LF ONLY:
- ALL POSITIONS ARE LOADED WITH "A" EXCEPT AS SHOWN.
  - COLUMN 1, ROW A IS DESIGNATED AS SIGNAL PIN 1, AS VIEWED FROM THE MATING FACE.
  - SIGNAL DATA FOR 50006-XX057 AND 50006-XX057LF:  
 SIZE 3 x 50  
 TOTAL NO. OF POSITIONS - 150  
 NO. OF POSITIONS LOADED - 150

ITEM KEY	QTY.	MATING LENGTH	TAIL LENGTH
A	101	.220 / 5.59	.561 / 14.25
B	1	.180 / 4.57	.521 / 13.23
C	8	.260 / 6.60	.601 / 15.27
D	40	.220 / 5.59	.177 / 4.50

mat'l. code		surface ISO 1302		tolerance ISO 406 ISO 1101		projection		product family			
ltr		ecn no	dr	date	tolerances unless otherwise specified		title		HPC		
P		angles		linear		.XX±.01/.3 .XXX±.005/.13 .XXXX±.0020/.051		INCH/MM		3 ROW VERTICAL HEADER W/PRESS-FIT PINS, 0 G.P.	
		0°±2'		dr		D.SHEAFER 1991-03-14		scale 1:1		sheet 14 of 16	
		engr		S.CLARK 1991-03-14		chr		S.ALOSIOUS 2011-05-23		50006	
		appd		BIJU K PAUL 2011-05-23		FCJ		type		Product Customer Drawing	
sheet index		revision sheet								A3	

Copyright FCJ  
 FCconnect.com

PRODUCT NUMBER
50006-XX058
50006-XX058LF

FOR PRODUCT NUMBER 50006-XX058 AND 50006-XX058LF

	1	5	10	15	20	25	30	35	40	
C	B	B								
B	B	B								
A	B	B								
PIN										
1										
	41	45	50	55	60	65	70	75	80	
										B B
										B B
										B B

CUSTOMER NOTE: END GUIDE PINS ARE SUGGESTED IN YOUR APPLICATION TO PREVENT STUBBING OF THE .260 MATING LENGTH SIGNAL PINS.

- NOTES FOR 50006-XX058 AND 50006-XX058LF ONLY:
- ALL POSITIONS ARE LOADED WITH "A" EXCEPT AS SHOWN.
  - COLUMN 1, ROW A IS DESIGNATED AS SIGNAL PIN 1, AS VIEWED FROM THE MATING FACE.
  - SIGNAL DATA FOR 50006-XX058 AND 50006-XX058LF:  
 SIZE 3 x 80  
 TOTAL NO. OF POSITIONS - 240  
 NO. OF POSITIONS LOADED - 240

ITEM KEY	QTY.	MATING LENGTH	TAIL LENGTH
A	228	.210 / 5.33	.533 / 13.54
B	12	.244 / 6.20	.533 / 13.54

mat'l. code		surface ISO 1302	tolerance ISO 406 ISO 1101	projection 	product family HPC
ltr	ecn no	dr	date	tolerances unless otherwise specified	title
P				angles linear 0°±2'	3 ROW VERTICAL HEADER W/PRESS-FIT PINS, 0 G.P.
				.XX±.01/.3 .XXX±.005/.13 .XXXX±.0020/.051	INCH/MM scale 1:1
		dr	S. ALOSIOUS	2011-05-23	dwg no
		engr	S. ALOSIOUS	2011-05-23	sheet 15 of 16 size
		chr	S. ALOSIOUS	2011-05-23	50006
		appd	BIJU K PAUL	2011-05-23	A3
sheet index	revision sheet				type Product Customer Drawing

Copyright FCI  
 FCconnect.com

PRODUCT NUMBER
50006-XX059
50006-XX059LF

FOR PRODUCT NUMBER 50006-XX059 AND 50006-XX059LF

	1	5	10	15	20	25	30	35	40	
C	B	B								
B	B	B								
A	B	B								
PIN										
1										
	41	45	50	55	60	65	70	75	80	
										B B
										B B
										B B

CUSTOMER NOTE: END GUIDE PINS ARE SUGGESTED IN YOUR APPLICATION TO PREVENT STUBBING OF THE .260 MATING LENGTH SIGNAL PINS.

- NOTES FOR 50006-XX059 AND 50006-XX059LF ONLY:
1. ALL POSITIONS ARE LOADED WITH "A" EXCEPT AS SHOWN.
  2. COLUMN 1, ROW A IS DESIGNATED AS SIGNAL PIN 1, AS VIEWED FROM THE MATING FACE.
  3. SIGNAL DATA FOR 50006-XX059 AND 50006-XX059LF:  
 SIZE 3 x 80  
 TOTAL NO. OF POSITIONS - 240  
 NO. OF POSITIONS LOADED - 240

ITEM KEY	QTY.	MATING LENGTH	TAIL LENGTH
A	228	.210 / 5.33	.660 / 16.76
B	12	.245 / 6.22	.660 / 16.76

mat'l. code		surface ISO 1302	tolerance ISO 406 ISO 1101	projection 	product family HPC
ltr	ecn no	dr	date	tolerances unless otherwise specified	title
P				angles linear .XX±.01/.3 .XXX±.005/.13 0'±2'	3 ROW VERTICAL HEADER W/PRESS-FIT PINS, 0 G.P.
				dr S. ALOSIOUS 2011-05-23	scale 1:1
				engr S. ALOSIOUS 2011-05-23	FCJ
				chr S. ALOSIOUS 2011-05-23	dwg no 50006 sheet 16 of 16 size A3
				appd BIJU K PAUL 2011-05-23	type Product Customer Drawing
sheet index	revision sheet				

Copyright FCI  
 FCconnect.com