



Technical Data Sheet

1.5mm Side Face Infrared LED

IR928-6C-F

Features

- High reliability
- High radiant intensity
- Peak wavelength $\lambda_p=940\text{nm}$
- 2.54mm Lead spacing
- Low forward voltage
- Pb.Free
- This product itself will remain within RoHS compliant version.



Descriptions

- EVERLIGHT's Infrared Emitting Diode (IR928-6C-F) is a high intensity diode, molded in a water clear plastic package.
- The miniature side-facing device has a chip, that emits radiation from the side of the clear package.

Applications

- Mouse
- Optoelectronic switch
- Infrared applied system

Device Selection Guide

LED Part No.	Chip	Lens Color
	Material	
IR928-6C-F	GaAlAs	Water clear

Package Dimensions

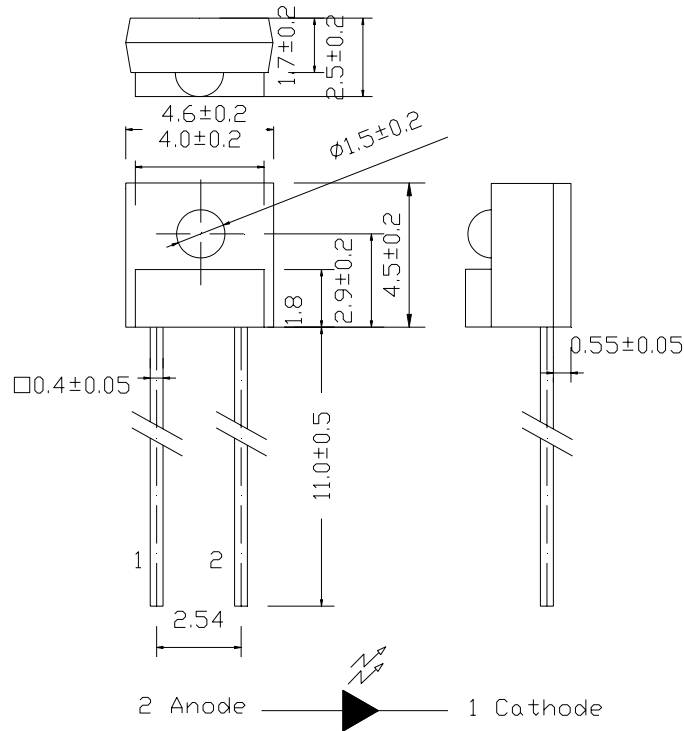

- Notes:** 1.All dimensions are in millimeters
 2.Tolerances unless dimensions $\pm 0.25\text{mm}$

Absolute Maximum Ratings (Ta=25°C)

Parameter	Symbol	Rating	Units
Continuous Forward Current	I_F	50	mA
Peak Forward Current(*1)	I_{FP}	1.0	A
Reverse Voltage	V_R	5	V
Operating Temperature	T_{opr}	-25 ~ +85	°C
Storage Temperature	T_{stg}	-40 ~ +85	°C
Soldering Temperature(*2)	T_{sol}	260	°C
Power Dissipation at(or below) 25°C Free Air Temperature	P_d	75	mW

- Notes:** *1: I_{FP} Conditions--Pulse Width $\leq 100 \mu s$ and Duty $\leq 1\%$.
 *2:Soldering time ≤ 5 seconds.

Electro-Optical Characteristics (Ta=25°C)

Parameter	Symbol	Condition	Min.	Typ.	Max.	Units
Light Current	Ic(ON)	I _F =4mA, V _{CE} =3.5V	265	--	1870	μA
Peak Wavelength	λ _p	I _F =20mA	--	940	--	nm
Spectral Bandwidth	Δλ	I _F =20mA	--	50	--	nm
Forward Voltage	V _F	I _F =20mA	--	1.2	1.5	V
Reverse Current	I _R	V _R =5V	--	--	10	μA
View Angle	2θ 1/2	I _F =20mA	--	40	--	deg

Wide Rank

Parameter	Symbol	Min	Max	Unit	Test Condition
5-2	Ic(ON)	1053	1870	μA	I _F =4mA, V _{CE} =3.5V
6-1	Ic(ON)	650	1274	μA	I _F =4mA, V _{CE} =3.5V
6-2	Ic(ON)	465	750	μA	I _F =4mA, V _{CE} =3.5V
7-1	Ic(ON)	347	550	μA	I _F =4mA, V _{CE} =3.5V
7-2	Ic(ON)	306	441	μA	I _F =4mA, V _{CE} =3.5V
7-3	Ic(ON)	265	358	μA	I _F =4mA, V _{CE} =3.5V

Thin Rank

Color Code	Ranks	Symbol	Min	Max	Unit	Test Condition
Yellow	E3	Ic(ON)	286	431	μA	I _F =4mA, V _{CE} =3.5V
Silver	E4	Ic(ON)	357	519	μA	I _F =4mA, V _{CE} =3.5V
Green	E5	Ic(ON)	428	608	μA	I _F =4mA, V _{CE} =3.5V
Purple	E6	Ic(ON)	500	696	μA	I _F =4mA, V _{CE} =3.5V
White	E7	Ic(ON)	571	784	μA	I _F =4mA, V _{CE} =3.5V
Brown	E8	Ic(ON)	643	872	μA	I _F =4mA, V _{CE} =3.5V
Orange	E9	Ic(ON)	714	960	μA	I _F =4mA, V _{CE} =3.5V

Typical Electro-Optical Characteristics Curves

Fig.1 Forward Current vs. Ambient Temperature

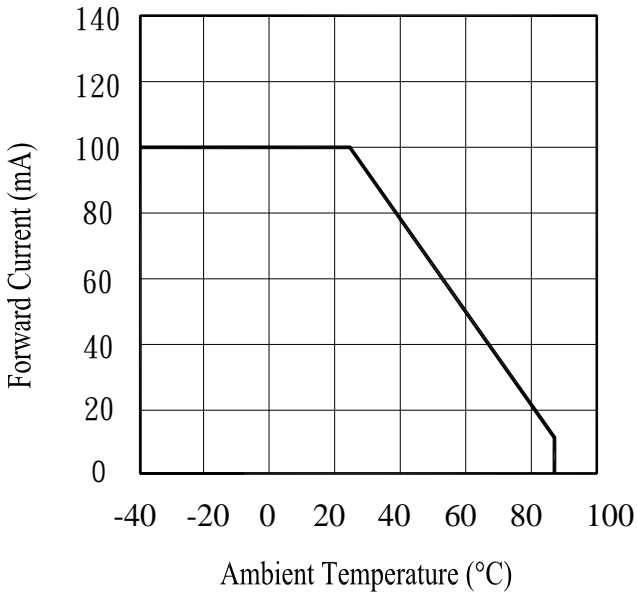

Fig.2 Spectral Distribution

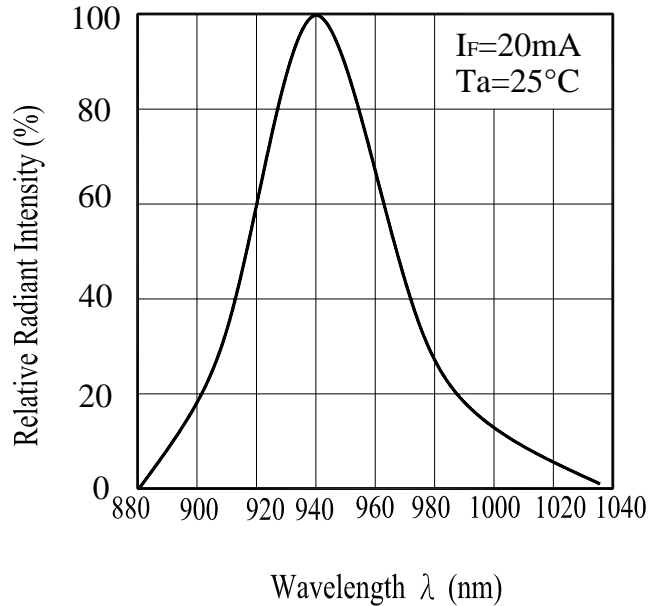

Fig.3 Peak Emission Wavelength vs. Ambient Temperature

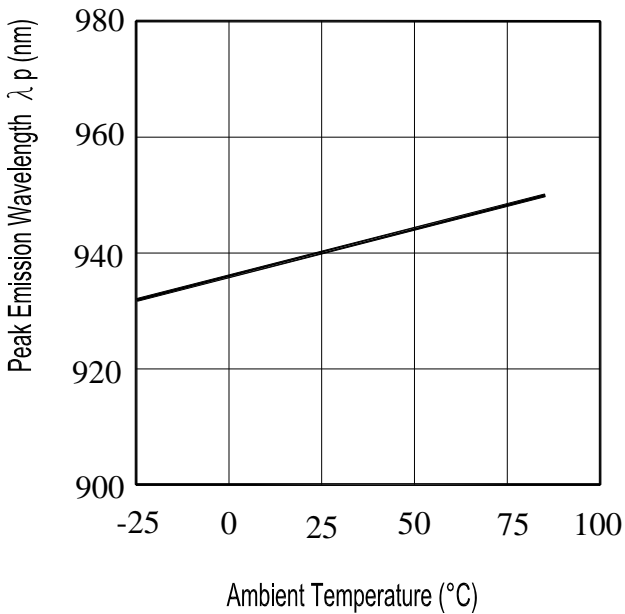
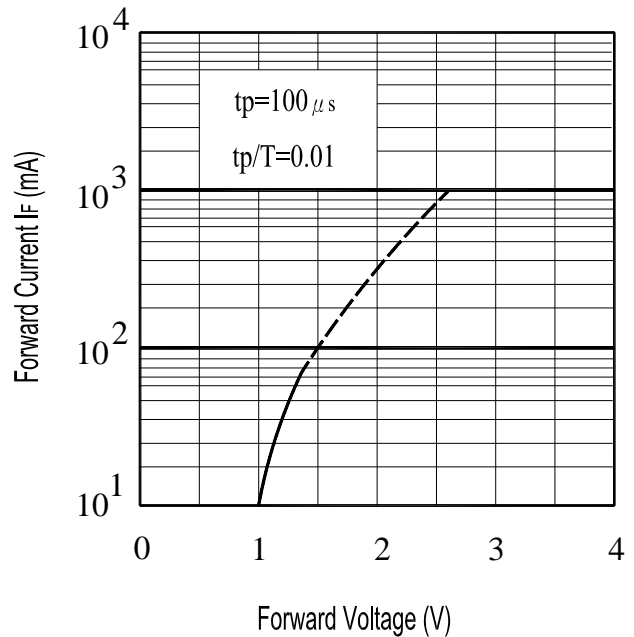

Fig.4 Forward Current vs. Forward Voltage



Typical Electro-Optical Characteristics Curves

Fig.5 Forward Voltage vs. Ambient Temperature

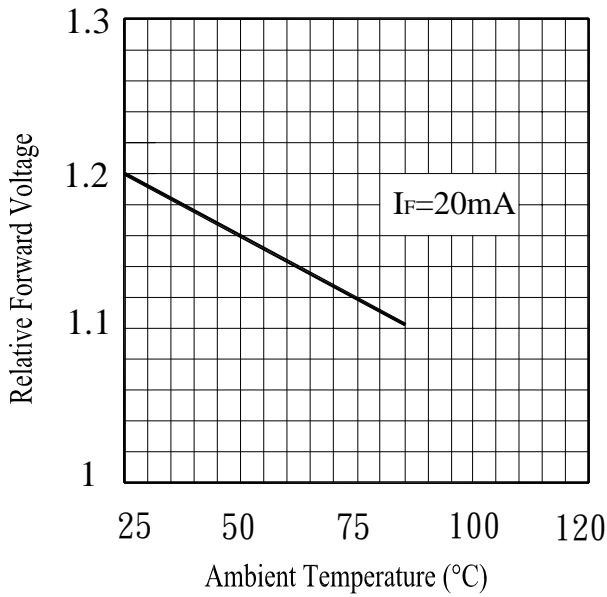
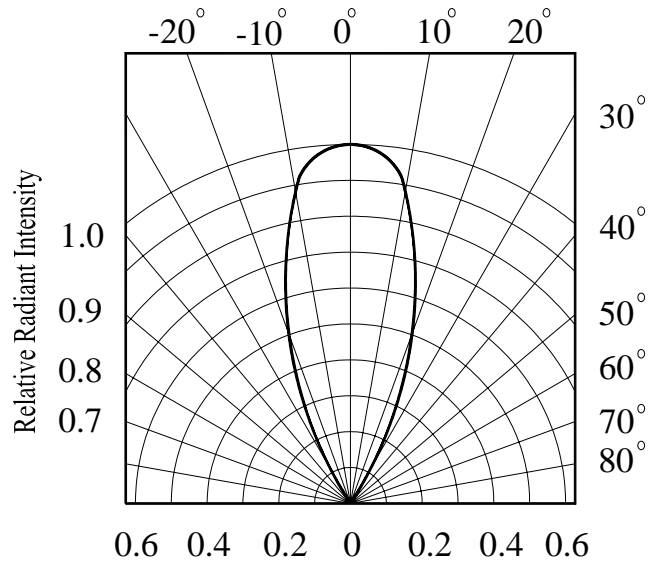

Fig.6 Relative Radiant Intensity vs. Angular Displacement



■ **Test Method For $I_{C(ON)}$:**

Condition: $I_F=4mA, V_{CE}=3.5V$

The intensity testing method for infrared emitting diode

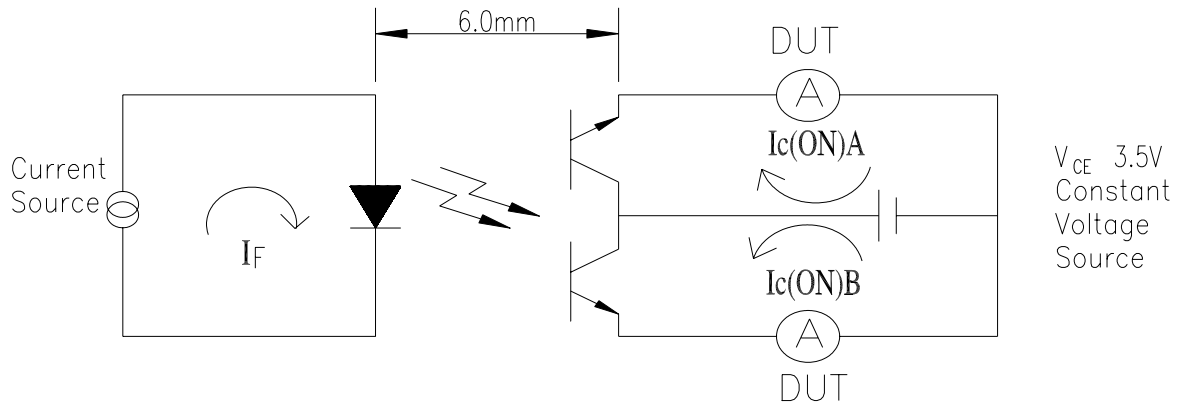



Packing Quantity Specification

- 1. 1000PCS/1Bag,10Bag/1Box
- 2. 10Boxes/1Carton

Label Form Specification



CPN: Customer's Production Number
P/N : Production Number
QTY: Packing Quantity
CAT: Ranks
HUE: Peak Wavelength
REF: Reference
LOT No: Lot Number

Notes

- 1. Above specification may be changed without notice. EVERLIGHT will reserve authority on material change for above specification.
- 2. When using this product, please observe the absolute maximum ratings and the instructions for using outlined in these specification sheets. EVERLIGHT assumes no responsibility for any damage resulting from use of the product which does not comply with the absolute maximum ratings and the instructions included in these specification sheets.
- 3. These specification sheets include materials protected under copyright of EVERLIGHT corporation. Please don't reproduce or cause anyone to reproduce them without EVERLIGHT's consent.

EVERLIGHT ELECTRONICS CO., LTD.
Office: No 25, Lane 76, Sec 3, Chung Yang Rd,
Tucheng, Taipei 236, Taiwan, R.O.C
Tel: 886-2-2267-2000, 2267-9936
Fax: 886-2267-6244, 2267-6189, 2267-6306
<http://www.everlight.com>