



The new caps for the Multimec switches 1DS / 1ES / 1FS is optimized with a “snap on” system to ensure the cap to stay on the switch actuator even under heavy vibrations or similar scenarios.

- The 1DS cap is a solid cap which can be supplied in different colours
- The 1ES cap is a solid cap like 1DS, but with a small round lens for intensive or smooth illumination
- The 1FS cap is a solid cap like 1DS, but with a large round lens for intensive or smooth illumination



Distributor:

Technical Data

- through-hole or SMD
- 50mA/24VDC
- single pole/momentary
- 10.000.000 operations life time
- IP67 sealing
- temperature range:
LED: -40/+85°C
solid cap +65°C
transparent +85°C
- actuation force: 2.0, 3.5, 6.5 N



Dimensions (through-hole)

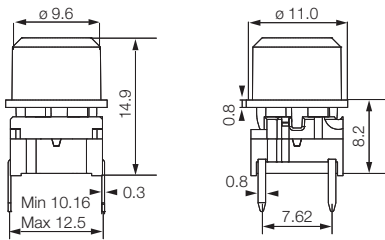

PCB layout

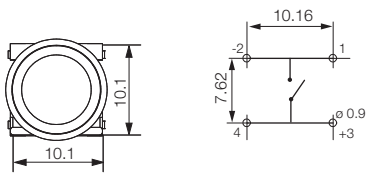

Dimensions (w. LED)

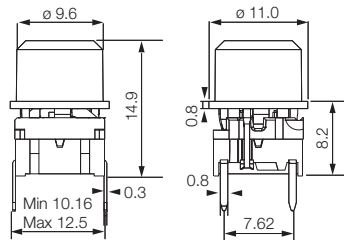

PCB layout

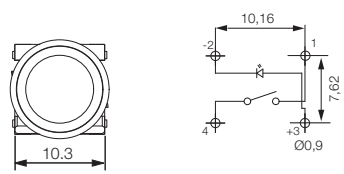

Dimensions (SMD)

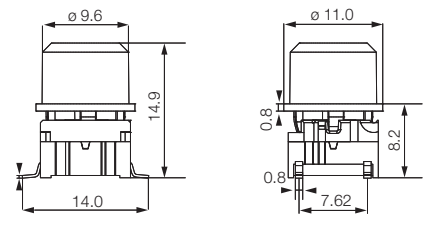

PCB layout

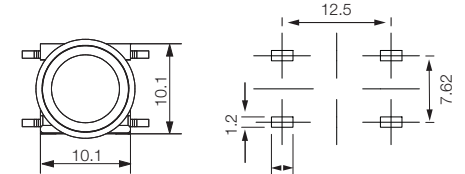

HOW TO ORDER

5 G	<input type="checkbox"/>	<input type="checkbox"/>	<input type="checkbox"/>	<input type="checkbox"/>	<input type="checkbox"/>	<input type="checkbox"/>
Switch	Mounting	Actuation force	LED	Cap	Colour code	Lens
	TH9 through-hole	20	01 blue	1ES with lens	00 blue	1 transparent
	SH9 surface mount	35	22 green		03 grey	6 frosted white
		65	42 yellow	1FS with lens	08 red	
			61 white		09 black	
			82 red			
			2242 green/yellow			
			8222 red/green			
			8242 red/yellow			
				1DS		
					11 transparent	
					16 frosted white	

5 G	<input type="checkbox"/>	<input type="checkbox"/>	<input type="checkbox"/>	<input type="checkbox"/>	<input type="checkbox"/>
Switch	Mounting	Actuation force	Cap	Colour code	
	TH9 through-hole	20	1DS solid colour	00 blue	
	SH9 surface mount	35		02 green	
		65		03 grey	
				04 yellow	
				06 white	
				08 red	
				09 black	

Dimensions (mm) Unless otherwise specified, all tolerances ±0,2

Ordering example: 5GTH935 + 1DS08

See colour codes on our website: www.mec.dk



All standard legends are white on black caps.
The size of the legends listed may not correspond to the actual size. Please ask your local distributor, if you do not find what you need on the list. New legends may have been added after this catalogue was printed.
Custom legends and other colour combinations are available, please contact your local distributor.

Note!

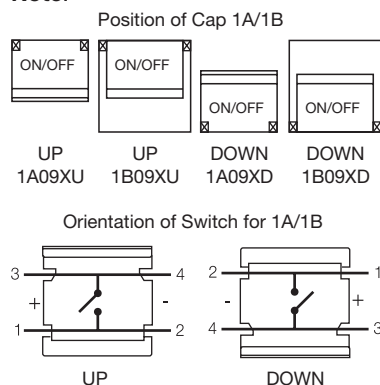

For 1A/1B the orientation shown above is standard.

Please consider the switch orientation you require before specifying legend orientation.

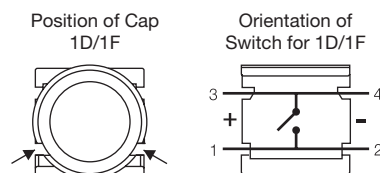

For the 1D and 1F caps the orientation shown above is standard.

Please consider the switch orientation you require before specifying legend orientation.

Standard Keycap Legends

LEGEND	Part no.						1ZB09XD_	1ZC09_
	1A09XU_	1A09XD_	1B09XU_	1B09XD_	1D09_	1F096_		
0	000	000	000	000	000	000		
1	001	001	001	001	001	001		
2	002	002	002	002	002	002		
3	003	003	003	003	003	003		
4	004	004	004	004	004	004		
5	005	005	005	005	005	005		
6	006	006	006	006	006	006		
7	007	007	007	007	007	007		
8	008	008	008	008	008	008		
9	009	009	009	009	009	009		
A	010	010	010	010				
B	011	011	011	011				
C	012	012	012	012				
D	013	013	013	013				
#	107	107	107	107	107	107		
*	019	019	019	019	019	019		
☐	016	016	016	016				
→	033	033	033	033	033			
←	133	133	133	133	133			
↑	034	034	034	034	034			
↓	134	134	134	134	134			
↖	135	135	135	135	135	135		
+	054	054	054	054				
-	059	059	059	059				
•	056	056	056	056				
▲							136	
⏻	123	123	123	123	123	123		123*
START	031	031	031	031				
CLEAR	036	036	036	036				
LOAD	037	037	037	037				
RESET	038	038	038	038				038
CANCEL	048	048	048	048				
ENTER								105
OK								118
SET								119
MENU								120
FUNC								121
HOME								122

* 1ZC16 for illumination

Technical Data:

- through-hole or SMD
- 50mA/24VDC
- single pole/momentary
- 10.000.000 operations lifetime
- IP67 sealing
- temp. range: switch: -40/+160°C
LED: -30/+85°C
solid keycap: -40/+65°C
transparent keycap: -40/+85°C
- actuation force: 2.0, 3.5, 6.5 N

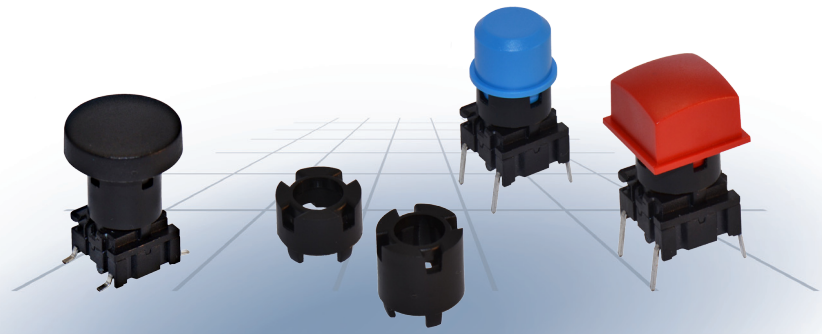

Dimensions (2SS)	Dimensions (SMD) + 1GCS	Dimensions (SMD) + 1DS	Dimensions (TH) + 1TS
<p>5mm, 6mm, 7mm, 8mm, 9mm, 10mm</p>			

HOW TO ORDER

5 G	<input type="text"/>	<input type="text"/>	<input type="text"/>	+	<input type="text"/>	+	2 S S 0 9 -	<input type="text"/>	. 0
Switch	Mounting	Actuation force	(LED)		Cap		Extender 2SS height		
	TH9 through-hole SH9 surface mount	20 35 65 Q*	01 blue 22 green 42 yellow 61 white 82 red 2242 green/yellow 8222 red/green 8242 red/yellow		See the table below		05.0 06.0 07.0 08.0 09.0 10.0		

2SS can be used with all 5G-type snap-on caps

All 2SS extenders are stackable giving the possibility to match most overall heights.

Keycap	Original height	Height with a single extender
1DS/1ES/1FS	14.9	19.9-24.9
1GAS/1GCS	12.5	17.5-22.5
1KS/1KBS/1KCS	19.1; 20.2; 20.1	24,1; 25,2; 25,1- 29,1; 30,2; 30,1
1NS	14.9	19.9-24.9
1TS/1US/1VS	14.9	19.9-24.9
1WAS/1WDS/1WPS	15.7	20.7-25.7
1XS	18.5	23.5-28.5
1ZCS	11.7	16.7-21.7

*Only available for actuation force 2.0N (20) and the letter Q is added to the end of the switch part number. See the ordering example.

Dimensions (mm) Unless otherwise specified, all tolerances +/- 0,2

Ordering example: 5GTH935+1GAS09+2SS09-06.0
*5GSH920Q or 5GTH92082Q (quiet version)

See colour codes on our website: www.mec.dk

For updates of products and/or changes of specifications please see www.mec.dk